



# MICS3-AAAZ40AZ1P01

microScan3

SAFETY LASER SCANNERS

**SICK**  
Sensor Intelligence.



Illustration may differ



### Ordering information

Type	part no.
MICS3-AAAZ40AZ1P01	1075842

Other models and accessories → [www.sick.com/microScan3](http://www.sick.com/microScan3)

### Detailed technical data

#### Features

<b>Product version</b>	microScan3 Core I/O
<b>Model</b>	Sensor including system plug
<b>Application</b>	Indoor
<b>Protective field range</b>	4 m
<b>Warning field range</b>	40 m
<b>Number of simultaneously monitored fields</b>	≤ 4 <sup>1) 2)</sup>
<b>Number of fields</b>	8 <sup>3)</sup>
<b>Number of monitoring cases</b>	2
<b>Scanning angle</b>	275°
<b>Resolution (can be configured)</b>	30 mm 40 mm 50 mm 70 mm 150 mm 200 mm
<b>Angular resolution</b>	0.39°
<b>Response time</b>	70 ms
<b>Protective field supplement</b>	65 mm

<sup>1)</sup> Protection, warning or contour detection fields.

<sup>2)</sup> Please note the number of available OSSD pairs.

<sup>3)</sup> Please note the number of available inputs and OSSD pairs.

#### Safety-related parameters

<b>Type</b>	Type 3 (IEC 61496)
<b>Safety integrity level</b>	SIL 2 (IEC 61508)
<b>Category</b>	Category 3 (EN ISO 13849)

<b>Performance level</b>	PL d (EN ISO 13849)
<b>PFH<sub>D</sub> (mean probability of a dangerous failure per hour)</b>	8.0 x 10 <sup>-8</sup>
<b>T<sub>M</sub> (mission time)</b>	20 years (EN ISO 13849)
<b>Safe state in the event of a fault</b>	At least one OSSD is in the OFF state.

### Functions

<b>Restart interlock</b>	✓
<b>External device monitoring (EDM)</b>	✓
<b>Multiple sampling</b>	✓
<b>Monitoring case switching</b>	✓
<b>Simultaneous monitoring</b>	✓
<b>Static protective field switching</b>	✓
<b>Safe contour detection</b>	✓
<b>Contour as a reference</b>	✓
<b>Integrated configuration memory</b>	✓
<b>Measured data output</b>	None

### Interfaces

<b>Connection type</b>	Male connector, M12, 8 pin, A-coded (common male connector for power supply and inputs and outputs)
<b>Universal I/Os</b>	3
<b>Outputs</b>	
	OSSD pairs 1
<b>Configuration method</b>	PC with Safety Designer (Configuration and Diagnostic Software)
<b>Configuration and diagnostics interface</b>	USB 2.0, Mini-USB
<b>Display elements</b>	Graphic color display, LEDs

### Electronics

<b>Protection class</b>	III (EN 61140)
<b>Supply voltage V<sub>s</sub></b>	24 V DC (16.8 V DC ... 30 V DC)
<b>Power consumption typical</b>	7 W (without output load)

### Mechanics

<b>Dimensions (W x H x D)</b>	112 mm x 135.1 mm x 111.1 mm
<b>Weight</b>	1.15 kg
<b>Housing material</b>	Aluminum
<b>Housing color</b>	RAL 1021 (yellow), RAL 9005 (black)
<b>Optics cover material</b>	Polycarbonate
<b>Optics cover surface finish</b>	Outside with scratch-resistant coating

### Ambient data

<b>Enclosure rating</b>	IP65 (IEC 60529)
<b>Ambient light immunity</b>	≤ 40 klx (IEC 61496-3) <sup>1)</sup>

<sup>1)</sup> Typical ambient light immunity, for ambient light sources directly in the scan plane in accordance with IEC 61496-3: ≤ 3 klx.

<b>Ambient operating temperature</b>	-10 °C ... +50 °C
<b>Storage temperature</b>	-25 °C ... +70 °C
<b>Vibration resistance</b>	IEC 60068-2-6, IEC 60068-2-64, IEC 60721-3-5, IEC TR 60721-4-3, IEC 61496-1, IEC 61496-3
Class	5M1 (IEC 60721-3-5) 3M4 (IEC TR 60721-4-3)
<b>Shock resistance</b>	IEC 60068-2-27, IEC 60721-3-5, IEC TR 60721-4-3, IEC 61496-1, IEC 61496-3
Class	5M1 (IEC 60721-3-5) 3M4 (IEC TR 60721-4-3)
Continuous shock	100 m/s <sup>2</sup> , 16 ms 150 m/s <sup>2</sup> , 6 ms
<b>EMC</b>	IEC 61496-1, IEC 61000-6-2, IEC 61000-6-4

<sup>1)</sup> Typical ambient light immunity, for ambient light sources directly in the scan plane in accordance with IEC 61496-3: ≤ 3 klx.

### Other information

<b>Type of light</b>	Pulsed laser diode
<b>Wave length</b>	845 nm
<b>Detectable remission factor</b>	1.8% to several 1000%
<b>Laser class</b>	1 (21 CFR 1040.10 and 1040.11, IEC 60825-1)

### Classifications

<b>ECLASS 5.0</b>	27272705
<b>ECLASS 5.1.4</b>	27272705
<b>ECLASS 6.0</b>	27272705
<b>ECLASS 6.2</b>	27272705
<b>ECLASS 7.0</b>	27272705
<b>ECLASS 8.0</b>	27272705
<b>ECLASS 8.1</b>	27272705
<b>ECLASS 9.0</b>	27272705
<b>ECLASS 10.0</b>	27272705
<b>ECLASS 11.0</b>	27272705
<b>ECLASS 12.0</b>	27272705
<b>ETIM 5.0</b>	EC002550
<b>ETIM 6.0</b>	EC002550
<b>ETIM 7.0</b>	EC002550
<b>ETIM 8.0</b>	EC002550
<b>UNSPSC 16.0901</b>	39121528

### Certificates

<b>EU declaration of conformity</b>	✓
<b>UK declaration of conformity</b>	✓
<b>ACMA declaration of conformity</b>	✓
<b>China RoHS</b>	✓
<b>cULus certificate</b>	✓

S Mark certificate	✓
EC-Type-Examination approval	✓
China GB certificate	✓
Information according to Art. 3 of Data Act (Regulation EU 2023/2854)	✓

### Dimensional drawing

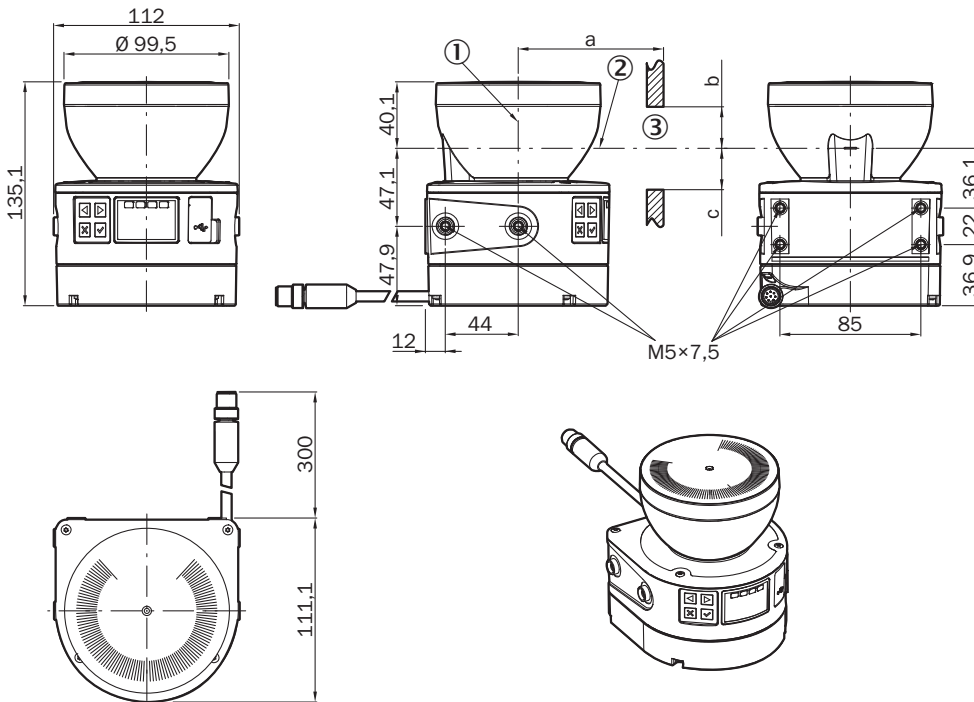

Dimensions in mm (inch)

① mirror axis of rotation

② scan plane

③ required viewing slit (a: length of the viewing slit, b: minimum height above the scan plane, c: minimum height below the scan plane. See the operating instructions for details.)

### Pinouts

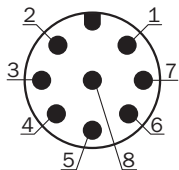

Pin	Designation	Description
1	+24 V DC	Supply voltage +24 V DC
2	OSSD 1.A	OSSD pair 1, OSSD A
3	0 V DC	Supply voltage 0 V DC
4	OSSD 1.B	OSSD pair 1, OSSD B

Pin	Designation	Description
5	Uni-I/O 01	Universal I/O 1, configurable
6	Uni-I/O 02	Universal I/O 2, configurable
7	Uni-I/O 03	Universal I/O 3, configurable
8	FE	Functional earth/shielding

For details see operating instructions

### Connection diagram microScan3 Core I/O with restart interlock and external device monitoring at RLY3-OSSD1 safety relay

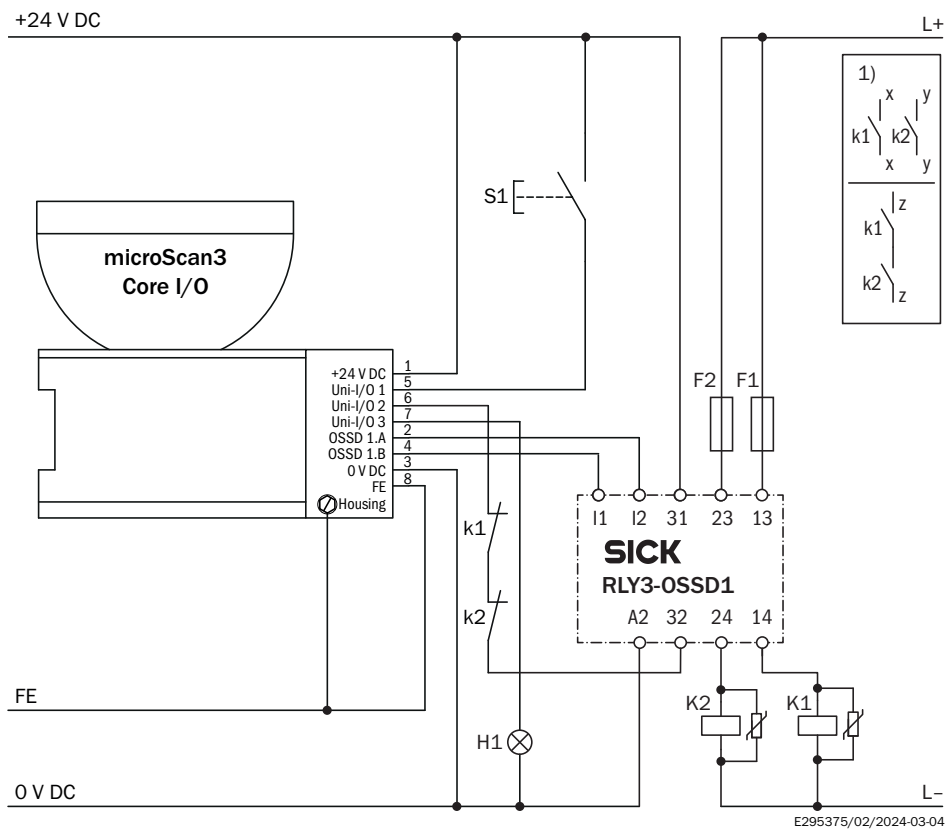

ⓘ Output circuits: These contacts must be incorporated into the control such that the dangerous state is brought to an end if the output circuit is open. For categories 4 and 3, they must be incorporated on dual-channels (x, y paths). Single-channel incorporation into the control (z path) is only possible with a single-channel control and taking the risk analysis into account.

Connection diagram microScan3 Core I/O with restart interlock and external device monitoring

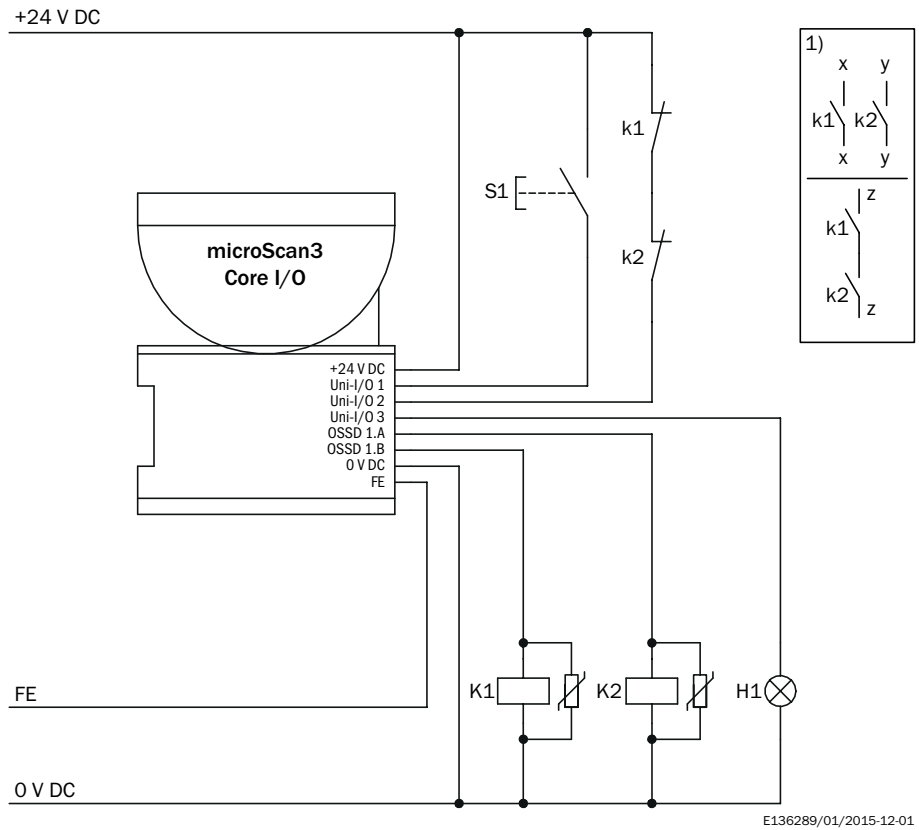







E136289/01/2015-12-01

① Output circuits: These contacts must be incorporated into the control such that the dangerous state is brought to an end if the output circuit is open. For categories 4 and 3, they must be incorporated on dual-channels (x, y paths). Single-channel incorporation into the control (z path) is only possible with a single-channel control and taking the risk analysis into account.

### Recommended accessories

Other models and accessories → [www.sick.com/microScan3](http://www.sick.com/microScan3)

	Brief description	Type	part no.
Mounting systems			
	<ul style="list-style-type: none"> <li><b>Description:</b> Mounting bracket, heavy-duty version, with protection cover, for floor mounting, height adjustment possible from 90 ... 310 mm, scanner tilt angle: ± 5°. Additional mounting brackets are not required.</li> <li><b>Dimensions (W x H x L):</b> 200 mm x 366 mm x 269 mm</li> <li><b>Material:</b> Steel</li> <li><b>Details:</b> Steel, painted (RAL 1021)</li> <li><b>Color:</b> RAL 1021 (yellow)</li> <li><b>Packing unit:</b> 1 piece</li> </ul>	Heavy-duty mounting kit for floor mounting	2102289
	<ul style="list-style-type: none"> <li><b>Description:</b> Mounting bracket with protection of optics hood</li> <li><b>Material:</b> Stainless steel</li> <li><b>Details:</b> Stainless steel V2A (1.4301), powder-coated IGP-DURA face 5803A</li> <li><b>Color:</b> RAL 9005 (black)</li> <li><b>Packing unit:</b> 1 piece</li> </ul>	1b mounting kit	2074242
	<ul style="list-style-type: none"> <li><b>Description:</b> Mounting bracket</li> <li><b>Material:</b> Stainless steel</li> <li><b>Details:</b> Stainless steel V2A (1.4301), powder-coated IGP-DURA face 5803A</li> <li><b>Color:</b> RAL 9005 (black)</li> <li><b>Packing unit:</b> 1 piece</li> </ul>	Mounting kit 1a	2073851
	<ul style="list-style-type: none"> <li><b>Description:</b> Alignment bracket, alignment with cross-wise axis and depth axis possible, distance between mounting surface and device: 22.3 mm, only in conjunction with mounting kit 1a (2073851) or 1b (2074242)</li> <li><b>Material:</b> Stainless steel</li> <li><b>Details:</b> Stainless steel V2A (1.4301), powder-coated IGP-DURA face 5803A</li> <li><b>Color:</b> RAL 9005 (black)</li> <li><b>Packing unit:</b> 1 piece</li> </ul>	Mounting kit 2a	2073852
	<ul style="list-style-type: none"> <li><b>Description:</b> Mounting bracket 150 mm for floor mounting of microScan3</li> <li><b>Material:</b> Stainless steel</li> <li><b>Details:</b> Stainless steel</li> <li><b>Color:</b> Uncoated</li> <li><b>Packing unit:</b> 1 piece</li> <li><b>Items supplied:</b> Bracket and 4 x M5 screws for attaching the microScan3</li> </ul>	Mounting bracket 150 mm for floor mounting of microScan3	2112950
	<ul style="list-style-type: none"> <li><b>Description:</b> Mounting bracket 300 mm for floor mounting of microScan3</li> <li><b>Material:</b> Stainless steel</li> <li><b>Details:</b> Stainless steel</li> <li><b>Color:</b> Uncoated</li> <li><b>Packing unit:</b> 1 piece</li> <li><b>Items supplied:</b> Bracket and 4 x M5 screws for attaching the microScan3</li> </ul>	Mounting bracket 300 mm for floor mounting of microScan3	2112951

	Brief description	Type	part no.
connectors and cables			
	<ul style="list-style-type: none"> <li><b>Description:</b> Sensor/actuator cable, unshielded</li> <li><b>Connection type head A:</b> Female connector, M12, 8-pin, straight, A-coded</li> <li><b>Connection type head B:</b> Flying leads</li> <li><b>Signal type:</b> Sensor/actuator cable</li> <li><b>Cable:</b> 2 m, 8-wire, PUR, halogen-free</li> <li><b>Connection systems:</b> Flying leads</li> <li><b>Application:</b> Drag chain operation, Zones with oils and lubricants</li> </ul>	DOL-1208G02MD25KM:	2079314
	<ul style="list-style-type: none"> <li><b>Description:</b> Sensor/actuator cable, unshielded</li> <li><b>Connection type head A:</b> Female connector, M12, 8-pin, straight, A-coded</li> <li><b>Connection type head B:</b> Flying leads</li> <li><b>Signal type:</b> Sensor/actuator cable</li> <li><b>Cable:</b> 5 m, 8-wire, PUR, halogen-free</li> <li><b>Connection systems:</b> Flying leads</li> <li><b>Application:</b> Drag chain operation, Zones with oils and lubricants</li> </ul>	DOL-1208G05MD25KM:	2079315
	<ul style="list-style-type: none"> <li><b>Description:</b> Sensor/actuator cable, unshielded</li> <li><b>Connection type head A:</b> Female connector, M12, 8-pin, straight, A-coded</li> <li><b>Connection type head B:</b> Flying leads</li> <li><b>Signal type:</b> Sensor/actuator cable</li> <li><b>Cable:</b> 10 m, 8-wire, PUR, halogen-free</li> <li><b>Connection systems:</b> Flying leads</li> <li><b>Application:</b> Drag chain operation, Zones with oils and lubricants</li> </ul>	DOL-1208G10MD25KM:	2079316
	<ul style="list-style-type: none"> <li><b>Description:</b> USB, shielded</li> <li><b>Connection type head A:</b> Male connector, USB-A, straight</li> <li><b>Connection type head B:</b> Male connector, Mini-USB, straight</li> <li><b>Signal type:</b> USB</li> <li><b>Cable:</b> 3 m, 4-wire</li> <li><b>Note:</b> For connecting the configuration connection to the USB interface on the PC</li> </ul>	Connection cable (male connector-male connector)	6042517
	<ul style="list-style-type: none"> <li><b>Description:</b> Sensor/actuator cable, unshielded</li> <li><b>Connection type head A:</b> Female connector, M12, 8-pin, straight, A-coded</li> <li><b>Connection type head B:</b> Flying leads</li> <li><b>Signal type:</b> Sensor/actuator cable</li> <li><b>Cable:</b> 20 m, 8-wire, PUR, halogen-free</li> <li><b>Connection systems:</b> Flying leads</li> <li><b>Application:</b> Drag chain operation, Zones with oils and lubricants</li> </ul>	DOL-1208G20MD25KM:	2092105
	<ul style="list-style-type: none"> <li><b>Description:</b> Sensor/actuator cable, unshielded</li> <li><b>Connection type head A:</b> Female connector, M12, 8-pin, straight, A-coded</li> <li><b>Connection type head B:</b> Flying leads</li> <li><b>Signal type:</b> Sensor/actuator cable</li> <li><b>Cable:</b> 30 m, 8-wire, PUR, halogen-free</li> <li><b>Connection systems:</b> Flying leads</li> <li><b>Application:</b> Drag chain operation, Zones with oils and lubricants</li> </ul>	DOL-1208G30MD25KM:	2092106
	<ul style="list-style-type: none"> <li><b>Description:</b> USB, shielded</li> <li><b>Connection type head A:</b> Male connector, USB-A, straight</li> <li><b>Connection type head B:</b> Male connector, Mini-USB, straight</li> <li><b>Signal type:</b> USB</li> <li><b>Cable:</b> 5 m, 4-wire</li> <li><b>Note:</b> For connecting the configuration connection to the USB interface on the PC</li> </ul>	Connection cable (male connector-male connector)	6053566

## SICK AT A GLANCE

SICK is one of the leading manufacturers of intelligent sensors and sensor solutions for industrial applications. A unique range of products and services creates the perfect basis for controlling processes securely and efficiently, protecting individuals from accidents and preventing damage to the environment.

We have extensive experience in a wide range of industries and understand their processes and requirements. With intelligent sensors, we can deliver exactly what our customers need. In application centers in Europe, Asia and North America, system solutions are tested and optimized in accordance with customer specifications. All this makes us a reliable supplier and development partner.

Comprehensive services complete our offering: SICK LifeTime Services provide support throughout the machine life cycle and ensure safety and productivity.

For us, that is “Sensor Intelligence.”

## WORLDWIDE PRESENCE:

Contacts and other locations –[www.sick.com](http://www.sick.com)