





### Ordering information

Type	part no.
DT1000-S11101	1075436

Other models and accessories → [www.sick.com/Dx1000](http://www.sick.com/Dx1000)

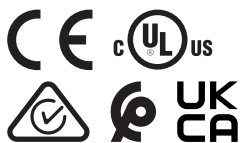

### Detailed technical data

#### Features

<b>Measurement principle</b>	HDDM <sup>+</sup>
<b>Measuring range</b>	0.2 m ... 155 m, 6% remission factor <sup>1) 2) 3)</sup> 0.2 m ... 460 m, 90% remission factor <sup>1) 2) 3)</sup>
<b>Target</b>	Natural objects
<b>Resolution</b>	1 µm ... 100,000 µm, adjustable <sup>4)</sup>
<b>Repeatability</b>	≥ 1 mm, See repeatability characteristic lines <sup>1) 5) 6) 7)</sup>
<b>Measurement accuracy</b>	Typ. ± 15 mm <sup>8) 9)</sup>
<b>Response time</b>	3 ms ... 384 ms <sup>7)</sup>
<b>Measurement cycle time</b>	1 ms 4 ms 16 ms 64 ms 128 ms
<b>Output time</b>	≥ 1 ms <sup>10)</sup>
<b>Emitted beam</b>	

<sup>1)</sup> With max. ambient light 100 kLux sunlight.

<sup>2)</sup> See measuring range diagram.

<sup>3)</sup> Dependent on remission and measuring cycle time.

<sup>4)</sup> Data interface resolution.

<sup>5)</sup> Statistical error 1 σ, environmental conditions constant, min. warm-up time > about 15 min.

<sup>6)</sup> 6% ... 90% remission factor.

<sup>7)</sup> Dependent on selected filter settings and measuring cycle time.

<sup>8)</sup> See measurement accuracy diagram.

<sup>9)</sup> At T = +23 °C and after warm-up time > about 15 min.

<sup>10)</sup> Depending on interface used.

<sup>11)</sup> See light spot size diagram.

<sup>12)</sup> Do not intentionally look into the laser beam. Never point the laser beam at people's eyes.

<sup>13)</sup> Measuring laser.

<sup>14)</sup> For object temperatures > +1,200 °C, the use of the additional filter is required for high-temperature applications. The additional filter reduces the measuring range limit by approx. 25%.

Typ. light spot size (distance)	5 mm x 20 mm (at 1 m) <sup>11)</sup>	
	20 mm x 20 mm (at 5 m) <sup>11)</sup>	
	35 mm x 25 mm (at 10 m) <sup>11)</sup>	
	150 mm x 50 mm (at 50 m) <sup>11)</sup>	
	290 mm x 80 mm (at 100 m) <sup>11)</sup>	
	570 mm x 140 mm (at 200 m) <sup>11)</sup>	
<b>Key laser figures</b>	Normative reference	IEC 60825-1:2014, EN 60825-1:2014
	Laser class	1 <sup>12)</sup>
	Average laser service life (at 25 °C)	100,000 h <sup>13)</sup>
<b>Filter</b>	Rain and snow filter Fog filter Moving average distance value Kalman filter Moving average speed value	
<b>Max. object temperature</b>	+1,400 °C <sup>14)</sup>	
<b>Additional function</b>	Selection of relevant distance and signal level range Selection of first or last echo in selected distance and signal level range	
<b>Max. movement speed</b>	128 m/s	
<b>Safety-related parameters</b>	MTTF <sub>D</sub>	101 years
	DC <sub>avg</sub>	0%

<sup>1)</sup> With max. ambient light 100 kLux sunlight.

<sup>2)</sup> See measuring range diagram.

<sup>3)</sup> Dependent on remission and measuring cycle time.

<sup>4)</sup> Data interface resolution.

<sup>5)</sup> Statistical error 1  $\sigma$ , environmental conditions constant, min. warm-up time > about 15 min.

<sup>6)</sup> 6% ... 90% remission factor.

<sup>7)</sup> Dependent on selected filter settings and measuring cycle time.

<sup>8)</sup> See measurement accuracy diagram.

<sup>9)</sup> At T = +23 °C and after warm-up time > about 15 min.

<sup>10)</sup> Depending on interface used.

<sup>11)</sup> See light spot size diagram.

<sup>12)</sup> Do not intentionally look into the laser beam. Never point the laser beam at people's eyes.

<sup>13)</sup> Measuring laser.

<sup>14)</sup> For object temperatures > +1,200 °C, the use of the additional filter is required for high-temperature applications. The additional filter reduces the measuring range limit by approx. 25%.

## Interfaces

<b>Ethernet</b>		✓, TCP/IP
	Function	Parameterization, output of measurement data
	Data transmission rate	10/100 MBit/s
<b>Serial</b>		✓, RS-422
	Remark	Switchable to SSI
	Function	Parameterization, output of measurement data

<sup>1)</sup> Short-circuit protected, switching voltage  $U_V$  - 4 V.

<sup>2)</sup> Internal pull-down switching, switching voltage HIGH: min. 13 V ... max. supply voltage, switching voltage LOW: max. 5 V.

<sup>3)</sup> Max. load =  $(U_V - 7 V) / 21.5 \text{ mA}$ .

<b>SSI</b>		✓
	Remark	Switchable to RS-422
	Function	Output of measurement data
<b>Inputs/outputs</b>		
	In1/Q1	Digital input, digital output (Switchable)
	QA/Q2	Analog output, digital output (Switchable)
	Q3	Digital Output
	Q4	Digital Output
	In2	Digital input
<b>Digital input</b>		Internal pull-down circuit HIGH switching voltage: min. 13 V ... max. supply voltage LOW switching voltage: max. 5 V Switching functions: deactivate measuring laser, activate alignment laser, preset
<b>Digital output</b>		
	Number	2 ... 4 <sup>1) 2)</sup>
	Type	Push-pull: PNP/NPN
	Maximum output current I <sub>A</sub>	≤ 100 mA
<b>Analog output</b>		
	Number	1
	Type	Current output
	Current	4 mA ... 20 mA <sup>3)</sup>
	Resolution	16 bit

<sup>1)</sup> Short-circuit protected, switching voltage U<sub>V</sub> - 4 V.

<sup>2)</sup> Internal pull-down switching, switching voltage HIGH: min. 13 V ... max. supply voltage, switching voltage LOW: max. 5 V.

<sup>3)</sup> Max. load = (U<sub>V</sub> - 7 V) / 21.5 mA.

## Electronics

<b>Supply voltage U<sub>B</sub></b>	DC 18 V ... 30 V, reverse polarity protected
<b>Power consumption</b>	≤ 22 W, With heating switched off <sup>1)</sup> ≤ 35 W, With heating switched on <sup>1)</sup>
<b>Ripple</b>	≤ 5 V <sub>pp</sub> <sup>2)</sup>
<b>Initialization time</b>	> 15 s
<b>Display</b>	Graphical, resistive touch display, status LEDs
<b>Enclosure rating</b>	IP65 <sup>3)</sup> IP67 <sup>3)</sup>
<b>Protection class</b>	III (EN 61140)
<b>Connection type</b>	Round connector M12 x 1

<sup>1)</sup> With external load.

<sup>2)</sup> May not fall short of or exceed V<sub>S</sub> tolerances.

<sup>3)</sup> When plugged in with a suitable mating connector.

## Mechanics

<b>Dimensions (W x H x D)</b>	84 mm x 104.4 mm x 140.5 mm
<b>Housing material</b>	Metal (Aluminum alloy (AlSi12))

<b>Window material</b>	Glass
<b>Weight</b>	980 g

## Ambient data

<b>Ambient temperature, operation</b>	-40 °C ... +55 °C <sup>1)</sup> -40 °C ... +95 °C, operation with cooling case
<b>Ambient temperature, storage</b>	-40 °C ... +75 °C
<b>Max. rel. humidity (not condensing)</b>	≤ 95 %
<b>Effect of air pressure</b>	0.3 ppm/hPa
<b>Effect of air temperature</b>	-1 ppm/K
<b>Temperature drift</b>	Typ. 0.25 mm/K
<b>Typ. Ambient light immunity</b>	≤ 100,000 lx
<b>Mechanical load</b>	Shock: 30 g / 6 ms according to DIN EN 60068-2-27 (Ea), 6 axes Continuous shock: 25 g / 6 ms according to DIN EN 60068-2-27 (fatigue), 500 shocks, 6 axes

<sup>1)</sup> At a temperature of -40 °C, a warm-up time of typ. 20 minutes is required (when supply voltage  $V_s = 24$  V).

## Certificates

<b>EU declaration of conformity</b>	✓
<b>UK declaration of conformity</b>	✓
<b>ACMA declaration of conformity</b>	✓
<b>Moroccan declaration of conformity</b>	✓
<b>China RoHS</b>	✓
<b>cULus certificate</b>	✓
<b>Information according to Art. 3 of Data Act (Regulation EU 2023/2854)</b>	✓

## Classifications

<b>ECLASS 5.0</b>	27270801
<b>ECLASS 5.1.4</b>	27270801
<b>ECLASS 6.0</b>	27270801
<b>ECLASS 6.2</b>	27270801
<b>ECLASS 7.0</b>	27270801
<b>ECLASS 8.0</b>	27270801
<b>ECLASS 8.1</b>	27270801
<b>ECLASS 9.0</b>	27270801
<b>ECLASS 10.0</b>	27270801
<b>ECLASS 11.0</b>	27270801
<b>ECLASS 12.0</b>	27270916
<b>ETIM 5.0</b>	EC001825
<b>ETIM 6.0</b>	EC001825
<b>ETIM 7.0</b>	EC001825
<b>ETIM 8.0</b>	EC001825
<b>UNSPSC 16.0901</b>	41111613

### Dimensional drawing

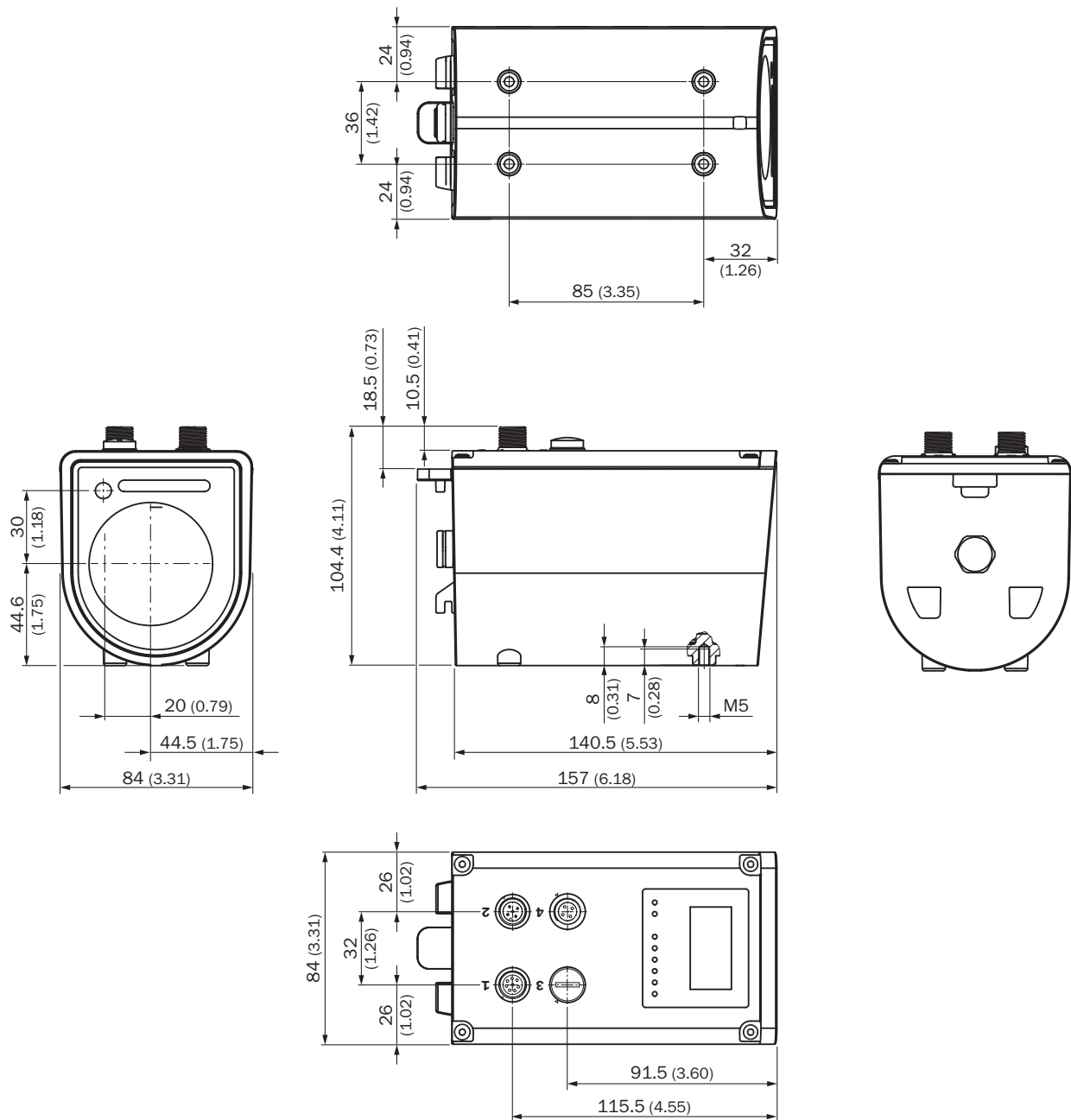

Dimensions in mm (inch)

Connection type Connection 2: Auxiliary

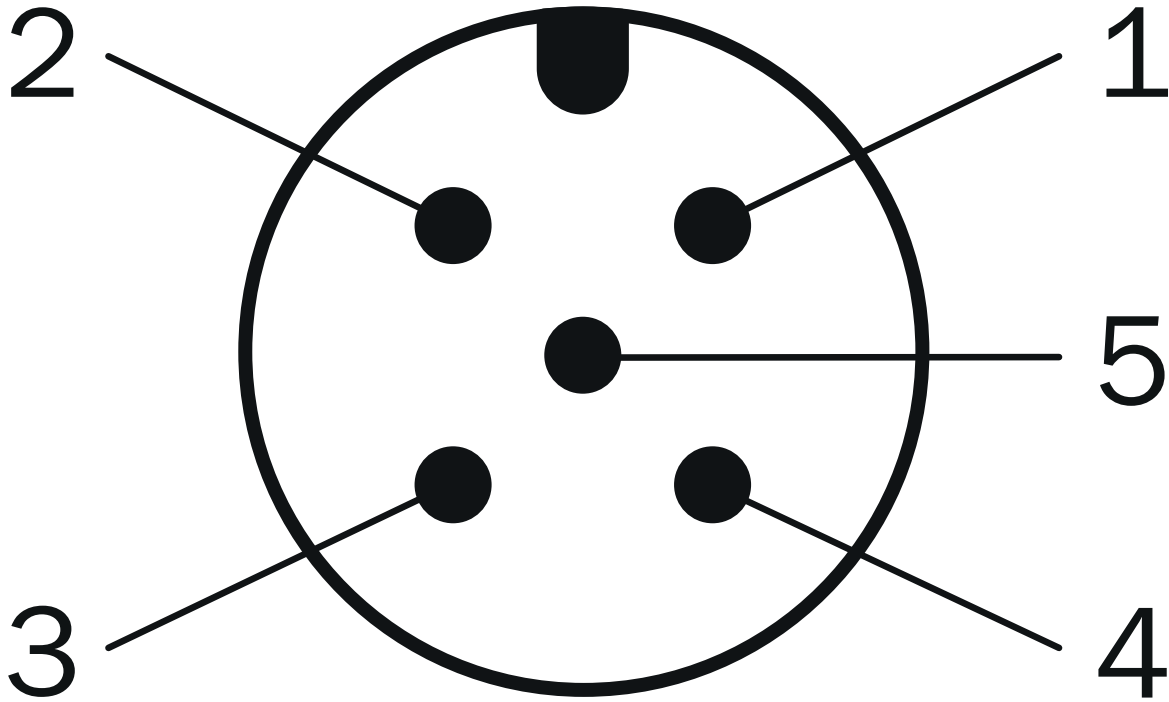

Connector M12, 5-pin, A-coded

- ① nc
- ② Q<sub>3</sub>
- ③ nc
- ④ Q<sub>4</sub>
- ⑤ In<sub>2</sub>

PIN assignment Connection 1: power, RS-422/SSI, Q1/In1, Q2/QA

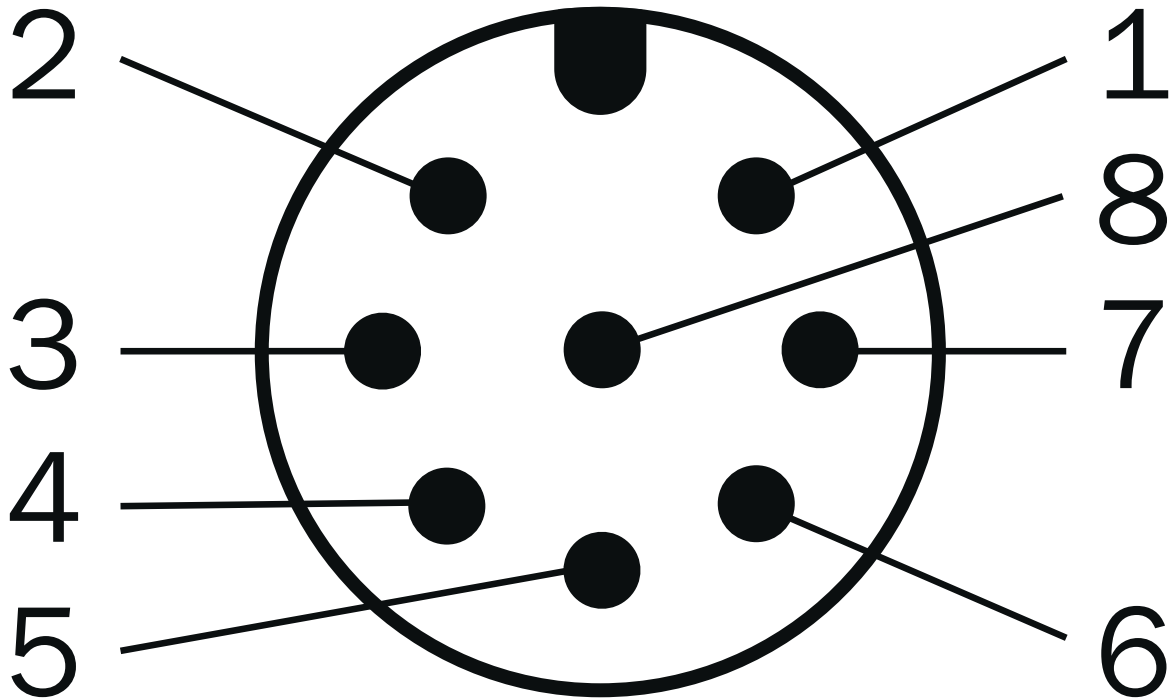

Connector M12, 8-pin, A-coded

- ① Q1/In1
- ② L+
- ③ RX-/CLK-
- ④ RX+/CLK+
- ⑤ TX-/Data-
- ⑥ TX+/Data+
- ⑦ M
- ⑧ Q2/QA

PIN assignment Connection 4: Ethernet

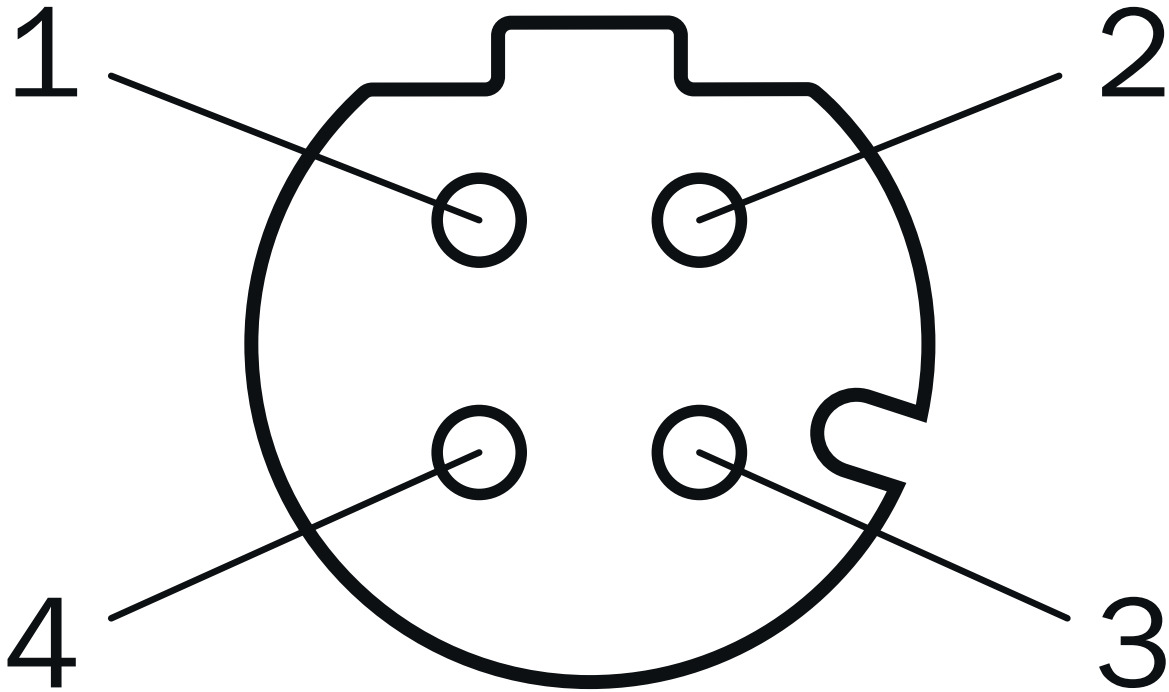

M12 female connector, 4-pin, D-coded

- ① TX+
- ② RX+
- ③ TX-
- ④ RX-

### Working range diagram DT1000 measuring range based on measurement cycle time and object remission

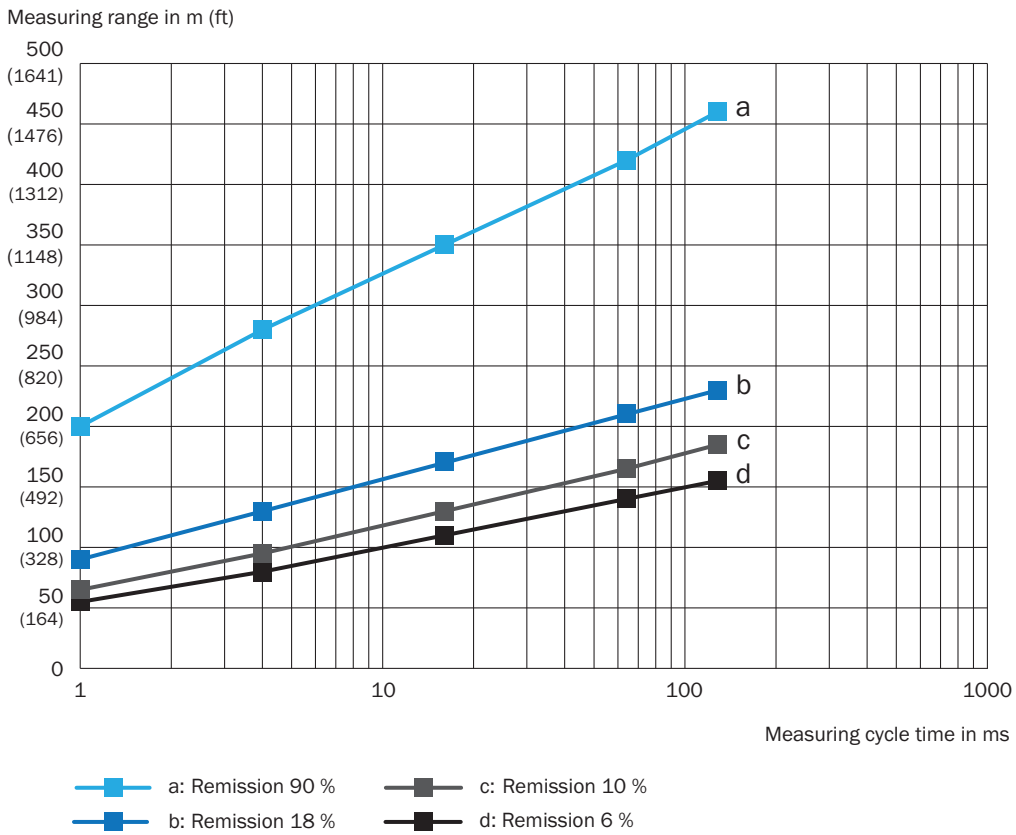

### Light spot size

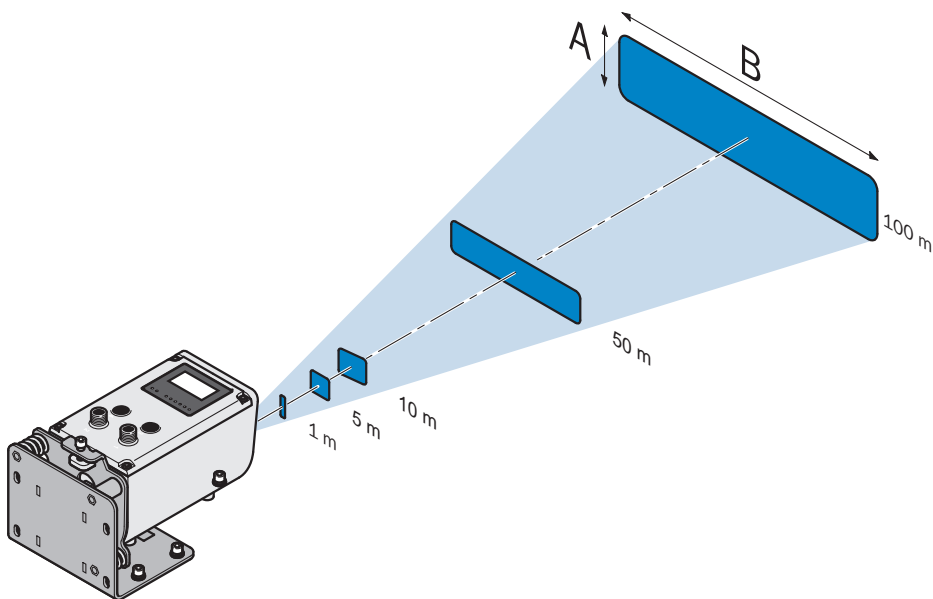

Functional principle

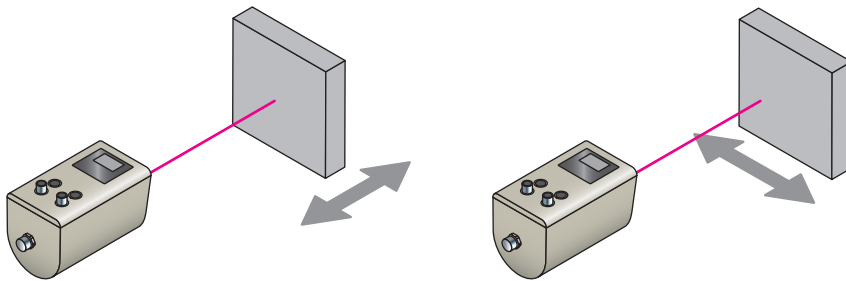

Repeatability DT1000, with 1 ms measurement cycle time

Typ. repeatability in mm (inch)

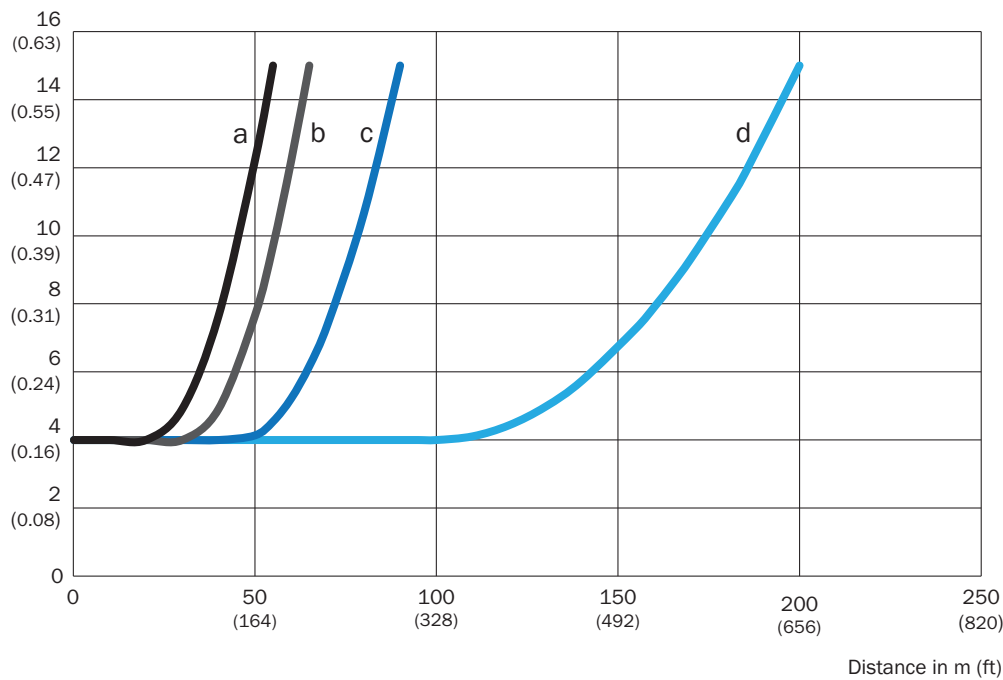

- a: Remission 6 %
- b: Remission 10 %
- c: Remission 18 %
- d: Remission 90 %

### Repeatability DT1000, with 16 ms measurement cycle time

Typ. repeatability in mm (inch)

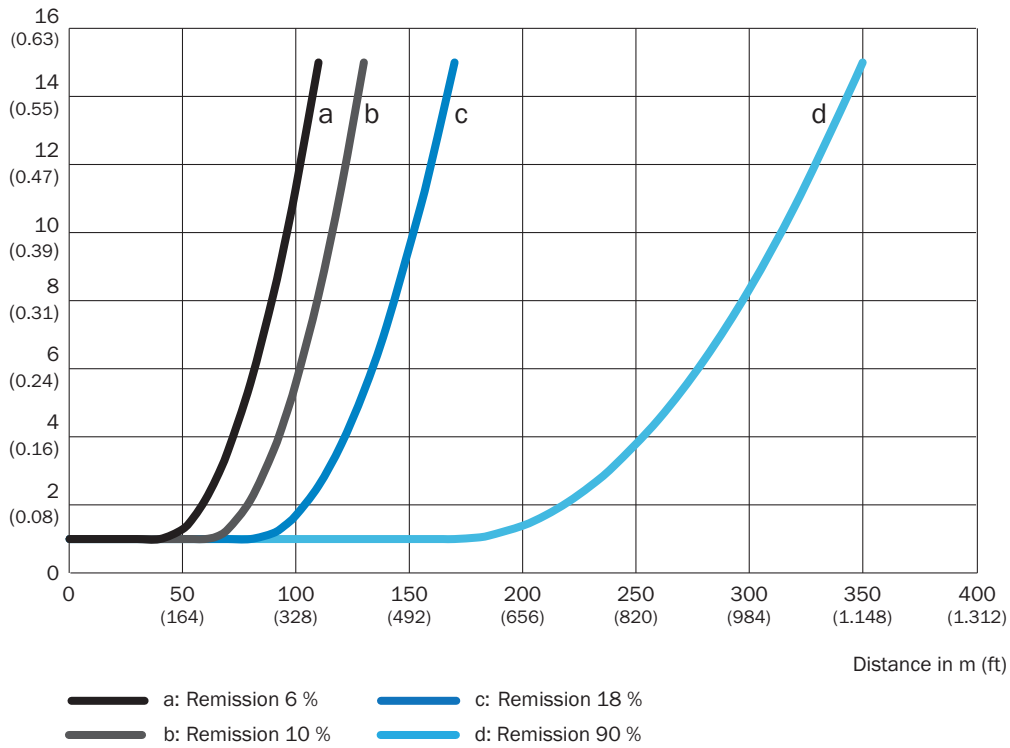

Repeatability DT1000, with 128 ms measurement cycle time

Typ. repeatability in mm (inch)

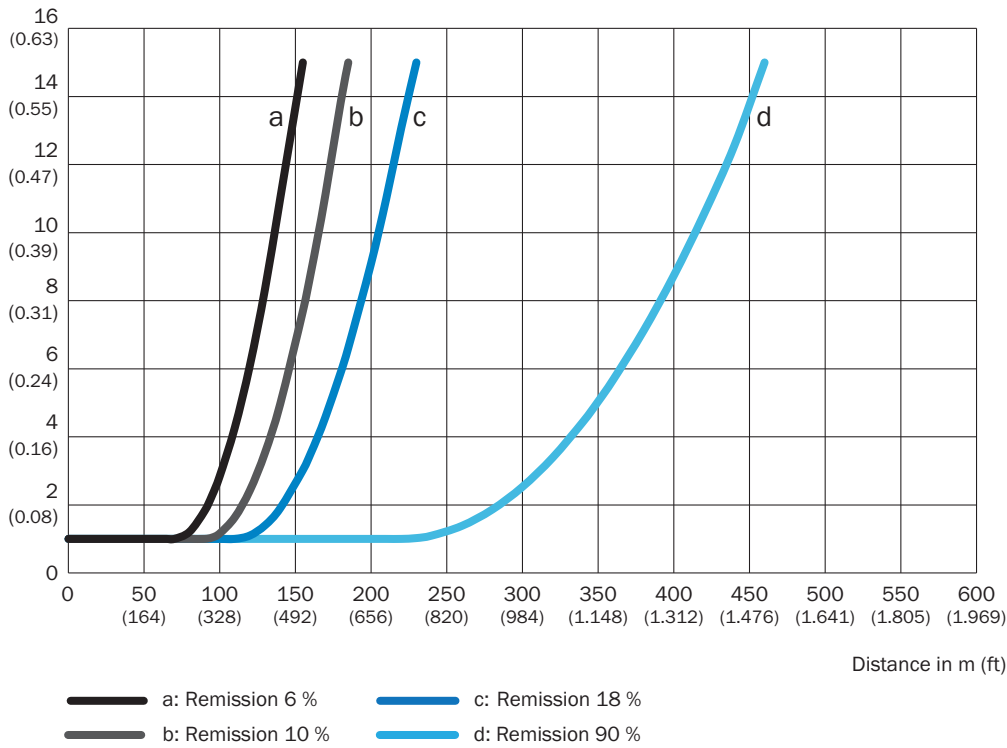

### Repeatability DT1000, with 4 ms measurement cycle time

Typ. repeatability in mm (inch)

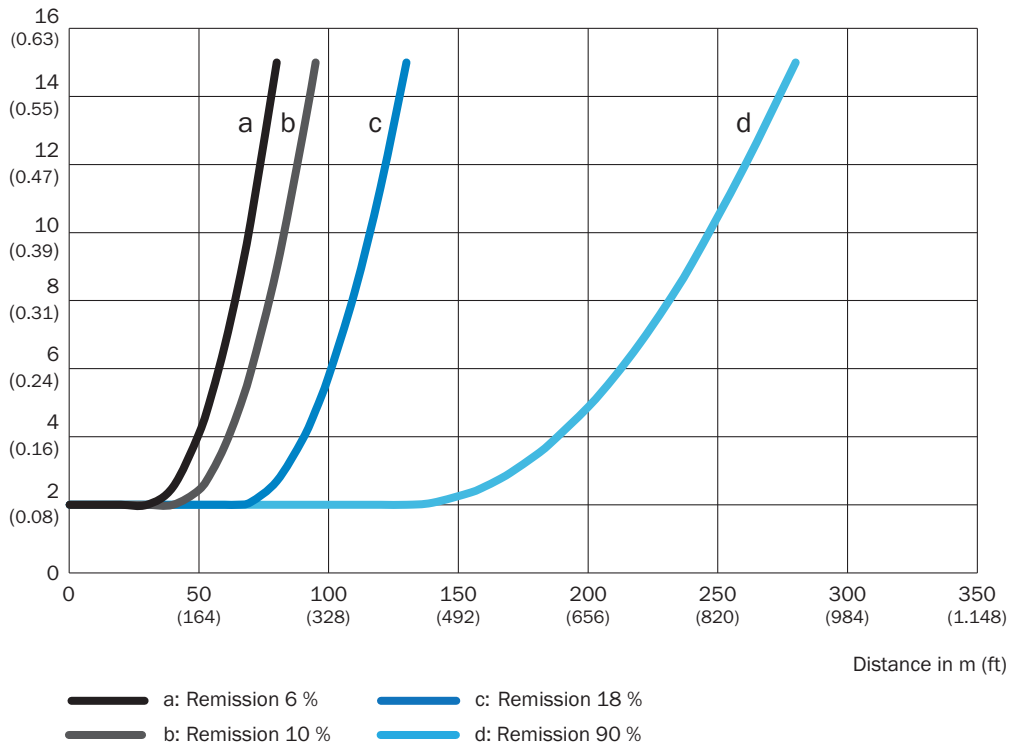

Repeatability DT1000, with 64 ms measurement cycle time

Typ. repeatability in mm (inch)

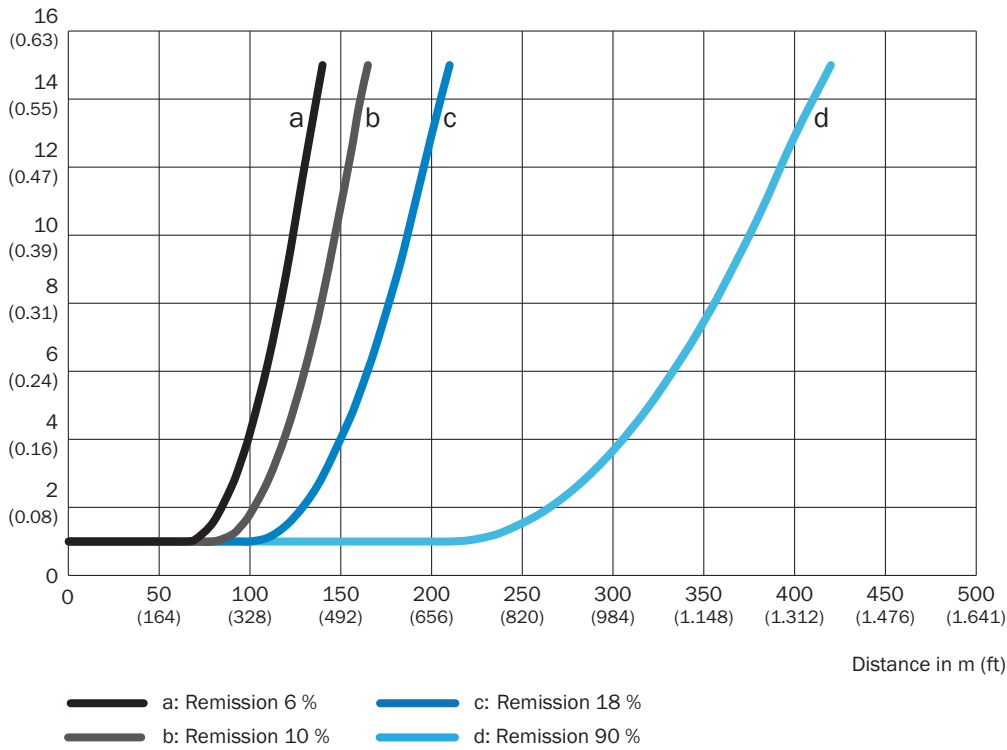

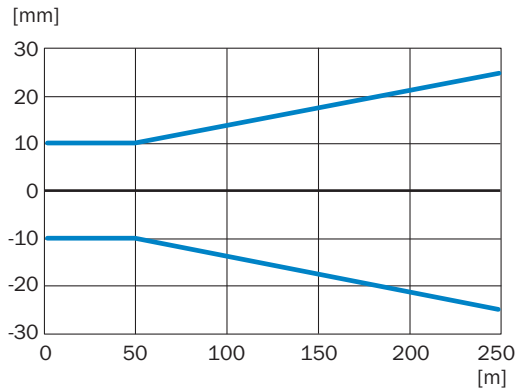

Measurement accuracy Typically DT1000, x-axis: Distance, y-axis: Typical measurement accuracy



### Recommended accessories

Other models and accessories → [www.sick.com/Dx1000](http://www.sick.com/Dx1000)

	Brief description	Type	part no.
device protection and care			
	<ul style="list-style-type: none"> <li><b>Description:</b> Can be opened upward without tools. Conductor for connections on the back. Due to space constraints, connecting cables with 90° angled, pre-assembled male connectors/female connectors are required.</li> <li><b>Items supplied:</b> Weatherproof housing (BEF-AH-DX1000, tube for weatherproof housing and rain cover for protective housing are not included with delivery)</li> </ul>	Weatherproof housing	2087690
connectors and cables			
	<ul style="list-style-type: none"> <li><b>Description:</b> RS-422, shielded, SSI</li> <li><b>Connection type head A:</b> Female connector, M12, 8-pin, angled</li> <li><b>Connection type head B:</b> Flying leads</li> <li><b>Signal type:</b> RS-422, SSI</li> <li><b>Cable:</b> 10 m, 8-wire, PUR, halogen-free</li> <li><b>Application:</b> Zones with oils and lubricants</li> </ul>	YG2A68-100XXXXLECX	6051482
Mounting systems			
	<ul style="list-style-type: none"> <li><b>Description:</b> Alignment bracket for mounting and precise alignment of the sensor in a horizontal and vertical direction</li> <li><b>Material:</b> Stainless steel</li> <li><b>Details:</b> Stainless steel</li> <li><b>Items supplied:</b> Mounting hardware included</li> </ul>	BEF-AH-DX1000	2080392

## SICK AT A GLANCE

SICK is one of the leading manufacturers of intelligent sensors and sensor solutions for industrial applications. A unique range of products and services creates the perfect basis for controlling processes securely and efficiently, protecting individuals from accidents and preventing damage to the environment.

We have extensive experience in a wide range of industries and understand their processes and requirements. With intelligent sensors, we can deliver exactly what our customers need. In application centers in Europe, Asia and North America, system solutions are tested and optimized in accordance with customer specifications. All this makes us a reliable supplier and development partner.

Comprehensive services complete our offering: SICK LifeTime Services provide support throughout the machine life cycle and ensure safety and productivity.

For us, that is “Sensor Intelligence.”

## WORLDWIDE PRESENCE:

Contacts and other locations –[www.sick.com](http://www.sick.com)