



WS/WE14-2P930

W14

PHOTOELECTRIC SENSORS

SICK
Sensor Intelligence.



Illustration may differ

Ordering information

Type	part no.
WS/WE14-2P930	1075289

Other models and accessories → www.sick.com/W14

Detailed technical data

Features

Functional principle	Through-beam photoelectric sensor
Dimensions (W x H x D)	17.6 mm x 75.5 mm x 33.5 mm
Housing design (light emission)	Rectangular
Sensing range max.	0 m ... 15 m
Sensing range	0 m ... 10 m
Type of light	Visible red light
Light source	LED ¹⁾
Light spot size (distance)	Ø 300 mm (10 m)
Wave length	645 nm
Adjustment	None

¹⁾ Average service life: 100,000 h at T_U = +25 °C.

Mechanics/electronics

Supply voltage	10 V DC ... 30 V DC ¹⁾
Power consumption, sender	35 mA ²⁾
Power consumption, receiver	25 mA ²⁾
Switching output	PNP
Output function	Complementary
Switching mode	Light/dark switching
Output current I_{max.}	≤ 100 mA

¹⁾ Limit values when operated in short-circuit protected network: max. 8 A.

²⁾ Without load.

³⁾ Signal transit time with resistive load.

⁴⁾ With light/dark ratio 1:1.

⁵⁾ Do not bend below 0 °C.

⁶⁾ A = V_S connections reverse-polarity protected.

⁷⁾ C = interference suppression.

⁸⁾ D = outputs overcurrent and short-circuit protected.

Response time	≤ 2.5 ms ³⁾
Switching frequency	200 Hz ⁴⁾
Connection type	Cable with M12 male connector, 4-pin, 0.29 m ⁵⁾
Cable material	PVC
Circuit protection	A ⁶⁾ C ⁷⁾ D ⁸⁾
Weight	90 g
Housing material	Plastic, ABS
Optics material	Plastic, PMMA
Enclosure rating	IP67
Ambient operating temperature	-25 °C ... +60 °C
Ambient temperature, storage	-40 °C ... +70 °C
UL File No.	NRKH.E181493 & NRKH7.E181493
Part number of individual components	2042379 WE14-2P930 2042380 WS14-2D930

1) Limit values when operated in short-circuit protected network: max. 8 A.

2) Without load.

3) Signal transit time with resistive load.

4) With light/dark ratio 1:1.

5) Do not bend below 0 °C.

6) A = V_S connections reverse-polarity protected.

7) C = interference suppression.

8) D = outputs overcurrent and short-circuit protected.

Safety-related parameters

MTTF_D	1,000 years
DC_{avg}	0 %

Classifications

ECLASS 5.0	27270901
ECLASS 5.1.4	27270901
ECLASS 6.0	27270901
ECLASS 6.2	27270901
ECLASS 7.0	27270901
ECLASS 8.0	27270901
ECLASS 8.1	27270901
ECLASS 9.0	27270901
ECLASS 10.0	27270901
ECLASS 11.0	27270901
ECLASS 12.0	27270901
ETIM 5.0	EC002716
ETIM 6.0	EC002716
ETIM 7.0	EC002716
ETIM 8.0	EC002716
UNSPSC 16.0901	39121528

Connection type

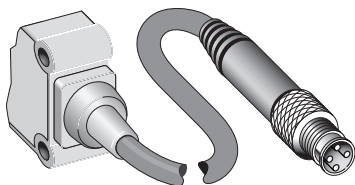

Connection diagram Cd-072

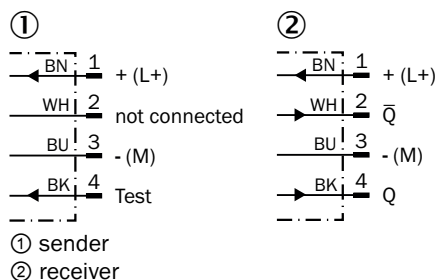

Characteristic curve WS/WE14-2

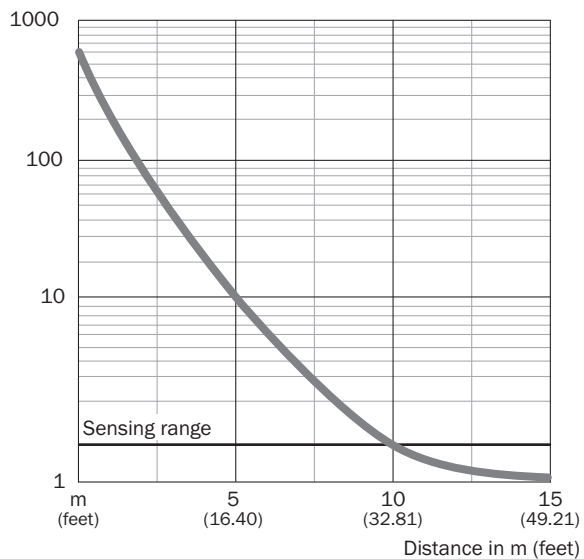

Sensing range diagram WS/WE14-2



Dimensional drawing WS/WE14-2

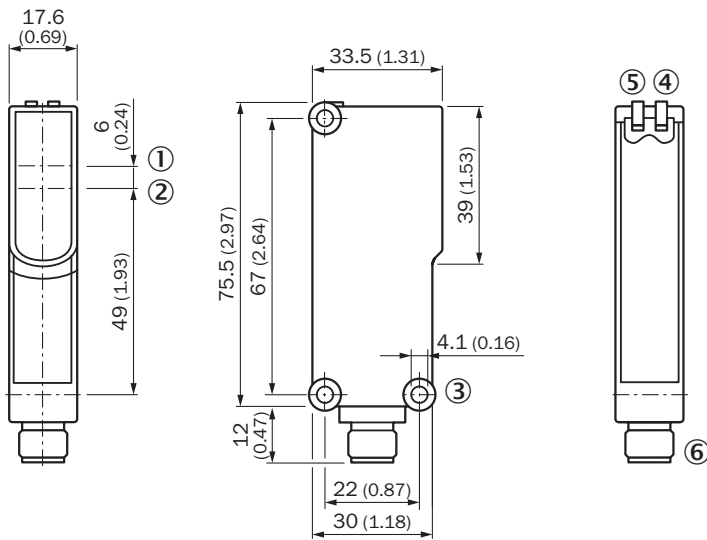







Dimensions in mm (inch)

- ① Optical axis, sender
- ② Optical axis, receiver
- ③ Mounting hole \varnothing 4.1 mm
- ④ LED indicator yellow: Status of received light beam
- ⑤ LED indicator green: Supply voltage active
- ⑥ M12 male connector, 4-pin or 2 m cable

Recommended accessories

Other models and accessories → www.sick.com/W14

	Brief description	Type	part no.
Mounting systems			
	<ul style="list-style-type: none"> Description: Mounting bracket Material: Steel Details: Steel, zinc coated Items supplied: Mounting hardware included Suitable for: W14-2, W18-3 	BEF-WN-W14	2019084
	<ul style="list-style-type: none"> Description: Mounting bracket with hinged arm Material: Steel Details: Steel, zinc coated Items supplied: Mounting hardware included Suitable for: W14-2, W18-3 	BEF-WN-W18	2009317
	<ul style="list-style-type: none"> Description: Plate N11N for universal clamp bracket Material: Stainless steel Details: Stainless steel 1.4571 (sheet), Stainless steel 1.4408 (clamp) Items supplied: Universal clamp (5322627), mounting hardware Usable for: DeltaPac, Glare, WTD20E 	BEF-KHS-N11N	2071081
connectors and cables			
	<ul style="list-style-type: none"> Description: Sensor/actuator cable, unshielded Connection type head A: Female connector, M12, 4-pin, straight Connection type head B: Flying leads Signal type: Sensor/actuator cable Cable: 5 m, 4-wire, PP Connection systems: Flying leads Note: This product is generally resistant to chemical cleaning agents (see ECOLAB) and other chemical compounds such as H2O2 and CH2O2. Before permanent installation is carried out, the material's resistance to the cleaning agent being used must be checked., Resistant against lactic acid & hydrogen peroxide (H2O2) Application: Hygienic and washdown zones, Drag chain operation, Robot, cold bending resistant, seawater resistant 	DOL-1204-G05MRN	6058476
	<ul style="list-style-type: none"> Description: Sensor/actuator cable, unshielded Connection type head A: Female connector, M12, 4-pin, straight, A-coded Connection type head B: Flying leads Signal type: Sensor/actuator cable Cable: 5 m, 4-wire, PUR, halogen-free Application: Drag chain operation, Zones with oils and lubricants, Robot, Drag chain operation 	YF2A14-050UB3XLEAX	2095608
	<ul style="list-style-type: none"> Description: Sensor/actuator cable, unshielded Connection type head A: Female connector, M12, 4-pin, straight, A-coded Connection type head B: Flying leads Signal type: Sensor/actuator cable Cable: 5 m, 4-wire, PVC Application: Uncontaminated zones, Zones with chemicals 	YF2A14-050VB3XLEAX	2096235
	<ul style="list-style-type: none"> Description: Unshielded Connection type head A: Male connector, M12, 4-pin, straight, A-coded Connection systems: Screw-type terminals Permitted cross-section: ≤ 0.75 mm² 	STE-1204-G	6009932

SICK AT A GLANCE

SICK is one of the leading manufacturers of intelligent sensors and sensor solutions for industrial applications. A unique range of products and services creates the perfect basis for controlling processes securely and efficiently, protecting individuals from accidents and preventing damage to the environment.

We have extensive experience in a wide range of industries and understand their processes and requirements. With intelligent sensors, we can deliver exactly what our customers need. In application centers in Europe, Asia and North America, system solutions are tested and optimized in accordance with customer specifications. All this makes us a reliable supplier and development partner.

Comprehensive services complete our offering: SICK LifeTime Services provide support throughout the machine life cycle and ensure safety and productivity.

For us, that is “Sensor Intelligence.”

WORLDWIDE PRESENCE:

Contacts and other locations –www.sick.com