



# EFS50-2KF0A121A

EFS/EFM50

MOTOR FEEDBACK SYSTEMS

**SICK**  
Sensor Intelligence.



Illustration may differ



### Ordering information

Type	part no.
EF50-2KF0A121A	1073495

Other models and accessories → [www.sick.com/EF5\\_EFM50](http://www.sick.com/EF5_EFM50)

### Detailed technical data

#### Safety-related parameters

<b>Safety integrity level</b>	SIL 2 (IEC 61508), SILCL2 (EN 62061) <sup>1)</sup>
<b>Category</b>	10 years
<b>Systematic suitability</b>	SC 3 (IEC61508)
<b>Test rate</b>	1 h
<b>Maximum demand rate</b>	216 µs
<b>Performance level</b>	PL d (EN ISO 13849)
<b>Safety-related resolution</b>	Channel 1 = 23 bit, channel 2 = 12 bit
<b>PFH (mean probability of a dangerous failure per hour)</b>	$3,8 \times 10^{-8}$
<b>Safety-related accuracy</b>	± 0.2°

<sup>1)</sup> For more detailed information on the exact configuration of your machine/unit, please consult your relevant SICK branch office.

#### Performance

<b>Position</b>	
Resolution per revolution	21 bit
System accuracy	± 52 "
Signal noise (σ)	± 2 "
Number of the absolute ascertainable revolutions	1
Available memory area	8,192 Byte
Measurement step per revolution	2,097,152
Measurement principle	Optical

#### Interfaces

<b>Code sequence</b>	Increasing, when turning the shaft For clockwise rotation, looking in direction "A" (see dimensional drawing)
<b>Communication interface</b>	HIPERFACE DSL®
<b>Initialization time</b>	Max. 500 ms <sup>1)</sup>

<sup>1)</sup> From reaching a permitted operating voltage.

<sup>2)</sup> Without sensor tolerance; at -17 °C ... +167 °C: NTC +2K (103 GT); PTC+3K (KTY84/130/PT1000).

<b>Measurement external temperature resistance</b>	32-bit value, without prefix (1 Ω) 0 ... 209.600 Ω <sup>2)</sup>
--	--

<sup>1)</sup> From reaching a permitted operating voltage.

<sup>2)</sup> Without sensor tolerance; at -17 °C ... +167 °C: NTC +2K (103 GT); PTC+3K (KTY84/130/PT1000).

## Electronics

<b>Connection type</b>	Male connector, 4-pin
<b>Supply voltage</b>	7 V ... 12 V
<b>Warm-up time voltage ramp</b>	Max. 180 ms <sup>1)</sup>
<b>Current consumption</b>	≤ 150 mA <sup>2)</sup>
<b>Output frequency for the digital position value</b>	0 kHz ... 75 kHz

<sup>1)</sup> Duration of the voltage ramp between 0 and 7.0 V, see diagram "Current consumption" in the diagram section.

<sup>2)</sup> Current rating applies when using interface circuit suggestions as shown in HIPERFACE DSL ® manual (8017595).

## Mechanics

<b>Shaft version</b>	Tapered shaft
<b>Flange type / stator coupling</b>	Stator coupling
<b>Dimensions</b>	See dimensional drawing
<b>Weight</b>	0.2 kg
<b>Moment of inertia of the rotor</b>	10 gcm <sup>2</sup>
<b>Operating speed</b>	≤ 12,000 min <sup>-1</sup>
<b>Angular acceleration</b>	≤ 200,000 rad/s <sup>2</sup>
<b>Start up torque</b>	≤ 0.4 Ncm
<b>Permissible radial shaft movement</b>	± 0.2 mm <sup>1)</sup>
<b>Permissible axial shaft movement</b>	± 0.95 mm
<b>Permissible movement static</b>	± 0.1 mm, radial ± 0.95 mm, axial
<b>Permissible movement dynamic</b>	± 0.05 mm, radial
<b>Life of ball bearings</b>	See diagram 3

<sup>1)</sup> Permitted when using the elastomer stator coupling. When the spring plate stator coupling is being used, voltage-free mounting is assumed.

## Ambient data

<b>Operating temperature range</b>	-30 °C ... +115 °C <sup>1)</sup>
<b>Storage temperature range</b>	-40 °C ... +120 °C, without package
<b>Relative humidity/condensation</b>	90 %, Condensation not permitted
<b>Resistance to shocks</b>	100 g, 6 ms, 6 ms (according to EN 60068-2-27)
<b>Frequency range of resistance to vibrations</b>	20 g, 10 Hz ... 2,000 Hz (EN 60068-2-6)
<b>EMC</b>	According to EN 61000-6-2, EN 61000-6-3 and IEC 61326-3-1 <sup>2)</sup>
<b>Enclosure rating</b>	IP40, with mating plug inserted and closed cover (IEC 60529-1)

<sup>1)</sup> The max. internal sensor temperature may not exceed 125 °C. The defined measuring point on the encoder (see dimensional drawing) must be used for measuring the operating temperature. For typical values for self-heating, see diagram 3 (electrical) and diagram 4 (mechanical).

<sup>2)</sup> EMC according to the listed standards is guaranteed if the motor feedback system with mating plug inserted is connected to the central grounding point of the motor controller via a cable shield. If other screening concepts are used, users must perform their own tests.

### Certificates

<b>EU declaration of conformity</b>	✓
<b>UK declaration of conformity</b>	✓
<b>ACMA declaration of conformity</b>	✓
<b>China RoHS</b>	✓
<b>EC-Type-Examination approval</b>	✓
<b>Information according to Art. 3 of Data Act (Regulation EU 2023/2854)</b>	✓

### Classifications

<b>ECLASS 5.0</b>	27270590
<b>ECLASS 5.1.4</b>	27270590
<b>ECLASS 6.0</b>	27270590
<b>ECLASS 6.2</b>	27270590
<b>ECLASS 7.0</b>	27270590
<b>ECLASS 8.0</b>	27270590
<b>ECLASS 8.1</b>	27270590
<b>ECLASS 9.0</b>	27270590
<b>ECLASS 10.0</b>	27273805
<b>ECLASS 11.0</b>	27273901
<b>ECLASS 12.0</b>	27273901
<b>ETIM 5.0</b>	EC001486
<b>ETIM 6.0</b>	EC001486
<b>ETIM 7.0</b>	EC001486
<b>ETIM 8.0</b>	EC001486
<b>UNSPSC 16.0901</b>	41112113

Dimensional drawing

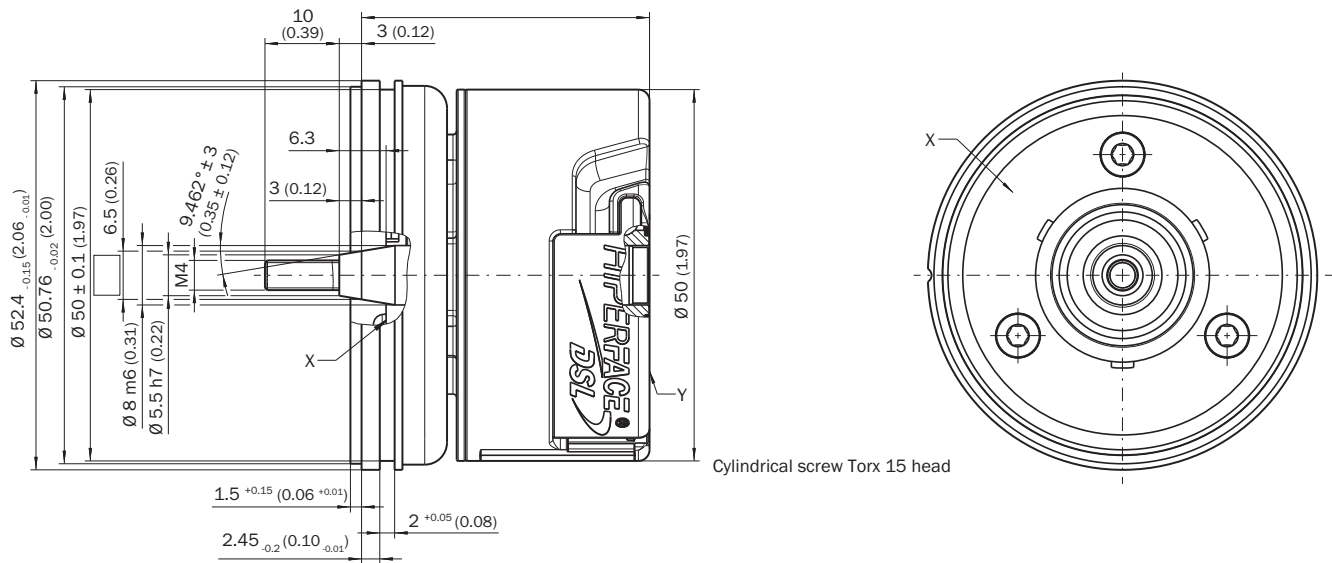

X = Measuring point for operating temperatur  
 Y = Measuring point for vibrations

Dimensions in mm (inch)

Anschlussbelegung Supply/Communication pin assignment

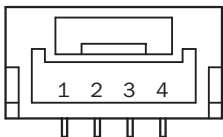

integrated in motor cable = J, K

PIN	Signal	Explanation
1	-	Not connected - no function
2	+U <sub>S</sub> /DSL+	Supply 7 V ... 12 V
3	GND/DSL-	Ground connection
4	-	Not connected - no function

Recommended outer diameter of set of stranded wires: 4 mm +0/-0.3 mm  
 Recommended mating connector: JST (GHR-04V-S)

Anschlussbelegung Temperature sensor pin assignment

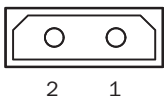

PIN	Signal	Explanation
1	T+	Thermistor connection
2	T-	Thermistor connection (to ground)

PIN	Signal	Explanation
Recommended outer diameter of set of stranded wires: 2.2 mm ± 0.1 mm		
Recommended mating connector: Harwin M80-8990205		

**Diagrams Mechanical self-heating**

Diagram 4

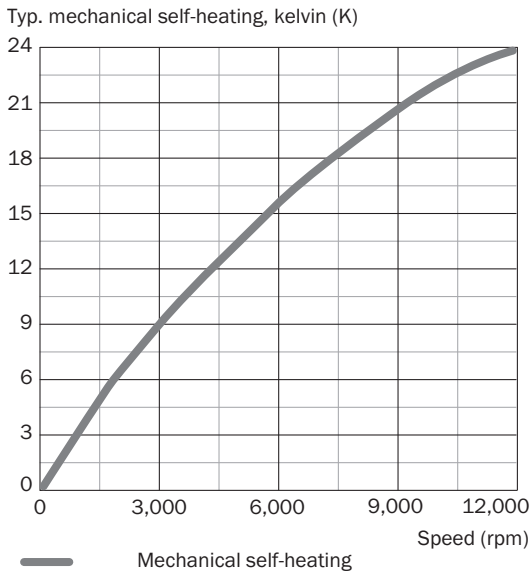

**Diagrams Electrical self-heating**

Diagram 3

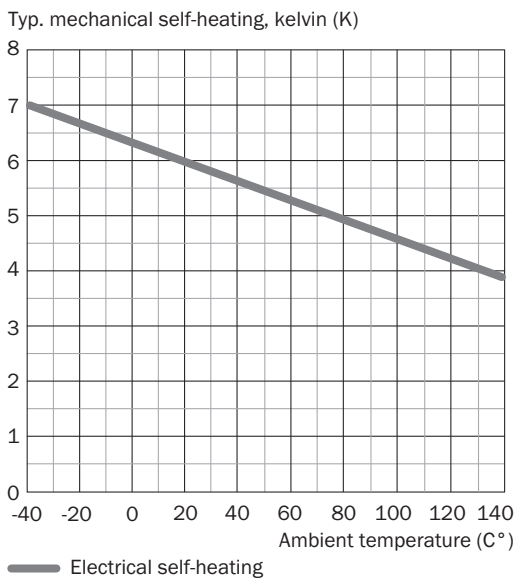

### Diagrams Power consumption

Diagram 2

Typ. current consumption (A)

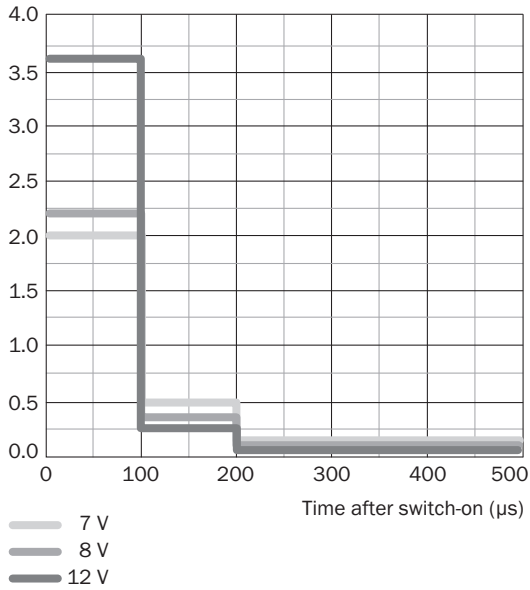

This diagram shows the switch-on current

### Diagrams Error limits

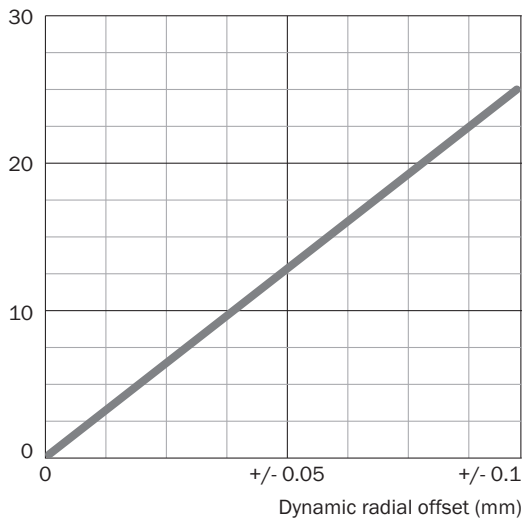

Diagram 1

Angular seconds (")



### Recommended accessories

Other models and accessories → [www.sick.com/EF5\\_EFM50](http://www.sick.com/EF5_EFM50)

	Brief description	Type	part no.
Mounting systems			
	<ul style="list-style-type: none"> <li><b>Description:</b> Servo clamps, small, for servo flange (clamps, eccentric fastener), 3 pcs, without mounting material</li> <li><b>Items supplied:</b> Without mounting hardware</li> </ul>	BEF-WK-RESOL	2039082
connectors and cables			
	<ul style="list-style-type: none"> <li><b>Description:</b> HIPERFACE DSL<sup>®</sup>, unshielded</li> <li><b>Connection type head A:</b> Female connector, stranded wire, 4-pin, straight</li> <li><b>Connection type head B:</b> Flying leads</li> <li><b>Signal type:</b> HIPERFACE DSL<sup>®</sup></li> <li><b>Cable:</b> 0.2 m, 2-wire</li> </ul>	DOL-0B02-G0M2XC2	2079920
	<ul style="list-style-type: none"> <li><b>Description:</b> HIPERFACE DSL<sup>®</sup>, twisted, shielded</li> <li><b>Connection type head A:</b> Female connector, stranded wire, 4-pin, straight</li> <li><b>Connection type head B:</b> Flying leads</li> <li><b>Signal type:</b> HIPERFACE DSL<sup>®</sup></li> <li><b>Cable:</b> 0.36 m, 2-wire</li> </ul>	DOL-0B02-G0M3AC2	2108944

## SICK AT A GLANCE

SICK is one of the leading manufacturers of intelligent sensors and sensor solutions for industrial applications. A unique range of products and services creates the perfect basis for controlling processes securely and efficiently, protecting individuals from accidents and preventing damage to the environment.

We have extensive experience in a wide range of industries and understand their processes and requirements. With intelligent sensors, we can deliver exactly what our customers need. In application centers in Europe, Asia and North America, system solutions are tested and optimized in accordance with customer specifications. All this makes us a reliable supplier and development partner.

Comprehensive services complete our offering: SICK LifeTime Services provide support throughout the machine life cycle and ensure safety and productivity.

For us, that is “Sensor Intelligence.”

## WORLDWIDE PRESENCE:

Contacts and other locations –[www.sick.com](http://www.sick.com)