



EFM50-OKF0A121A

EFS/EFM50

MOTOR FEEDBACK SYSTEMS

SICK
Sensor Intelligence.



Ordering information

Type	part no.
EFM50-0KFOA121A	1073494

Other models and accessories → www.sick.com/EFS_EFM50

Illustration may differ



Detailed technical data

Safety-related parameters

Test rate	1 h
------------------	-----

Performance

Position	
Resolution per revolution	21 bit
System accuracy	± 52 "
Signal noise (σ)	± 2 "
Number of the absolute ascertainable revolutions	4,096
Available memory area	8,192 Byte
Measurement step per revolution	2,097,152
Measurement principle	Optical

Interfaces

Code sequence	Increasing, when turning the shaft For clockwise rotation, looking in direction "A" (see dimensional drawing)
Communication interface	HIPERFACE DSL®
Initialization time	Max. 500 ms ¹⁾
Measurement external temperature resistance	32-bit value, without prefix (1 Ω) 0 ... 209.600 Ω ²⁾

¹⁾ From reaching a permitted operating voltage.

²⁾ Without sensor tolerance; at -17 °C ... +167 °C: NTC +2K (103 GT); PTC+3K (KTY84/130/PT1000).

Electronics

Connection type	Male connector, 4-pin
Supply voltage	7 V ... 12 V
Warm-up time voltage ramp	Max. 180 ms ¹⁾
Current consumption	≤ 150 mA ²⁾

¹⁾ Duration of the voltage ramp between 0 and 7.0 V, see diagram "Current consumption" in the diagram section.

²⁾ Current rating applies when using interface circuit suggestions as shown in HIPERFACE DSL® manual (8017595).

Output frequency for the digital position value	0 kHz ... 75 kHz
--	------------------

¹⁾ Duration of the voltage ramp between 0 and 7.0 V, see diagram "Current consumption" in the diagram section.

²⁾ Current rating applies when using interface circuit suggestions as shown in HIPERFACE DSL ® manual (8017595).

Mechanics

Shaft version	Tapered shaft
Flange type / stator coupling	Stator coupling
Dimensions	See dimensional drawing
Weight	0.2 kg
Moment of inertia of the rotor	10 gcm ²
Operating speed	≤ 9,000 min ⁻¹
Angular acceleration	≤ 200,000 rad/s ²
Start up torque	≤ 0.4 Ncm
Permissible radial shaft movement	± 0.2 mm ¹⁾
Permissible axial shaft movement	± 0.95 mm
Permissible movement static	± 0.1 mm, radial ± 0.95 mm, axial
Permissible movement dynamic	± 0.05 mm, radial
Life of ball bearings	See diagram 3

¹⁾ Permitted when using the elastomer stator coupling. When the spring plate stator coupling is being used, voltage-free mounting is assumed.

Ambient data

Operating temperature range	-30 °C ... +120 °C ¹⁾
Storage temperature range	-40 °C ... +120 °C, without package
Relative humidity/condensation	90 %, Condensation not permitted
Resistance to shocks	100 g, 6 ms, 6 ms (according to EN 60068-2-27)
Frequency range of resistance to vibrations	20 g, 10 Hz ... 2,000 Hz (EN 60068-2-6)
EMC	According to EN 61000-6-2, EN 61000-6-3 and IEC 61326-3-1 ²⁾
Enclosure rating	IP40, with mating plug inserted and closed cover (IEC 60529-1)

¹⁾ The max. internal sensor temperature may not exceed 125 °C. The defined measuring point on the encoder (see dimensional drawing) must be used for measuring the operating temperature. For typical values for self-heating, see diagram 3 (electrical) and diagram 4 (mechanical).

²⁾ EMC according to the listed standards is guaranteed if the motor feedback system with mating plug inserted is connected to the central grounding point of the motor controller via a cable shield. If other screening concepts are used, users must perform their own tests.

Certificates

EU declaration of conformity	✓
UK declaration of conformity	✓
ACMA declaration of conformity	✓
China RoHS	✓
Information according to Art. 3 of Data Act (Regulation EU 2023/2854)	✓

Classifications

ECLASS 5.0	27270590
ECLASS 5.1.4	27270590

ECLASS 6.0	27270590
ECLASS 6.2	27270590
ECLASS 7.0	27270590
ECLASS 8.0	27270590
ECLASS 8.1	27270590
ECLASS 9.0	27270590
ECLASS 10.0	27273805
ECLASS 11.0	27273901
ECLASS 12.0	27273901
ETIM 5.0	EC001486
ETIM 6.0	EC001486
ETIM 7.0	EC001486
ETIM 8.0	EC001486
UNSPSC 16.0901	41112113

Dimensional drawing

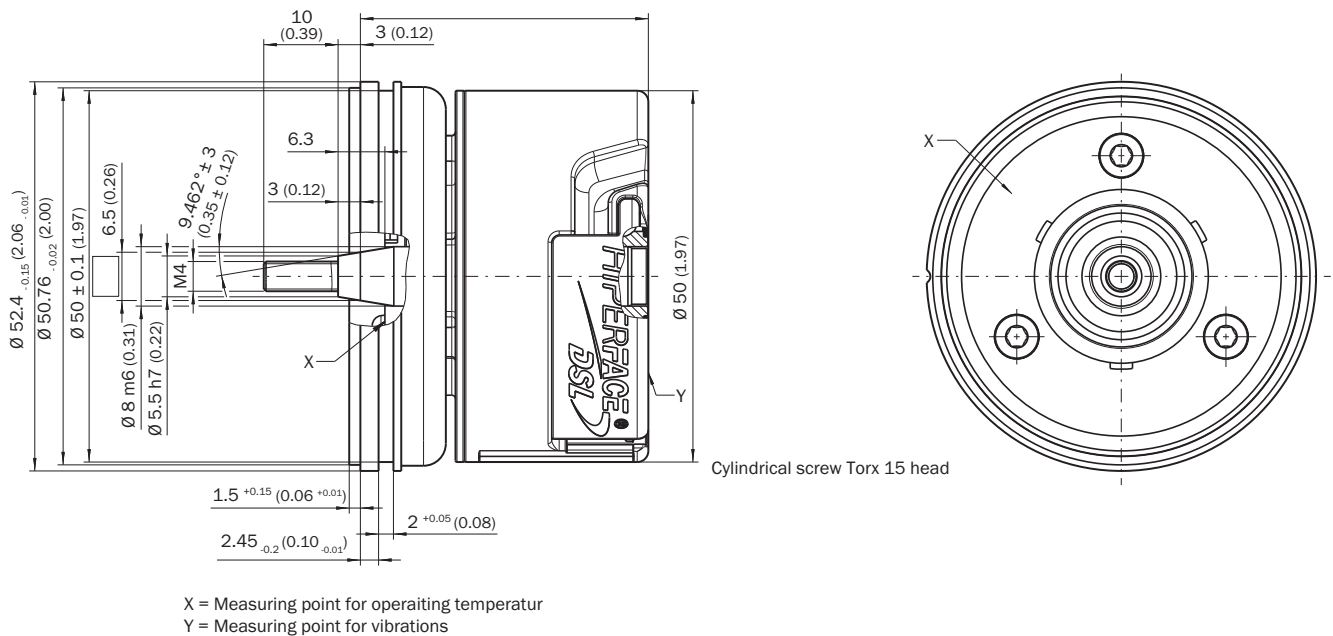

Dimensions in mm (inch)

Anschlussbelegung Supply/Communication pin assignment

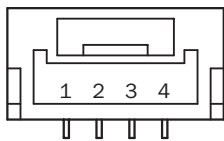

integrated in motor cable = J, K

PIN	Signal	Explanation
1	-	Not connected - no function
2	+U _S /DSL+	Supply 7 V ... 12 V
3	GND/DSL-	Ground connection
4	-	Not connected - no function

Recommended outer diameter of set of stranded wires: 4 mm +0/-0.3 mm
Recommended mating connector: JST (GHR-04V-S)

Anschlussbelegung Temperature sensor pin assignment

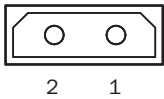

PIN	Signal	Explanation
1	T+	Thermistor connection
2	T-	Thermistor connection (to ground)

Recommended outer diameter of set of stranded wires: 2.2 mm ± 0.1 mm
Recommended mating connector: Harwin M80-8990205

Diagrams Mechanical self-heating

Diagram 4

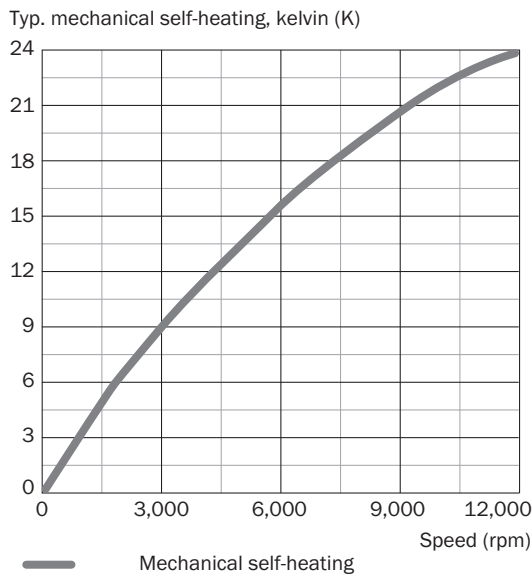

Diagrams Electrical self-heating

Diagram 3

Typ. mechanical self-heating, kelvin (K)

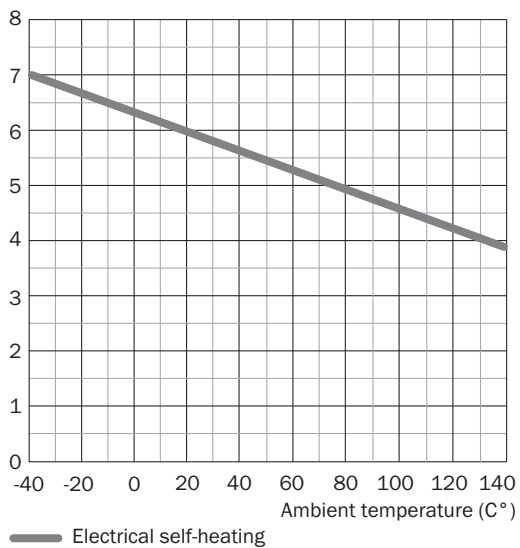

Diagrams Power consumption

Diagram 2

Typ. current consumption (A)

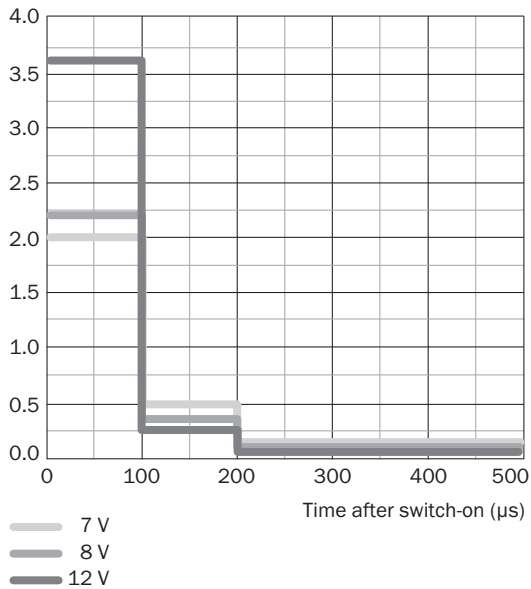

This diagram shows the switch-on current

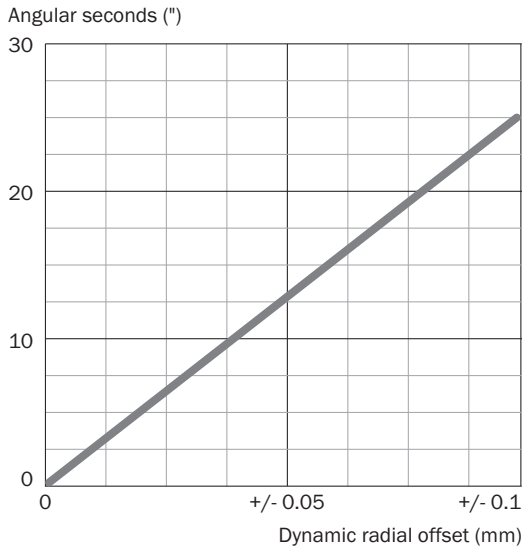

Diagrams Error limits

Diagram 1



Recommended accessories

Other models and accessories → www.sick.com/EFS_EFM50

	Brief description	Type	part no.
Mounting systems			
	<ul style="list-style-type: none"> Description: Servo clamps, small, for servo flange (clamps, eccentric fastener), 3 pcs, without mounting material Items supplied: Without mounting hardware 	BEF-WK-RESOL	2039082
connectors and cables			
	<ul style="list-style-type: none"> Description: HIPERFACE DSL[®], unshielded Connection type head A: Female connector, stranded wire, 4-pin, straight Connection type head B: Flying leads Signal type: HIPERFACE DSL[®] Cable: 0.2 m, 2-wire 	DOL-0B02-GOM2XC2	2079920
	<ul style="list-style-type: none"> Description: HIPERFACE DSL[®], twisted, shielded Connection type head A: Female connector, stranded wire, 4-pin, straight Connection type head B: Flying leads Signal type: HIPERFACE DSL[®] Cable: 0.36 m, 2-wire 	DOL-0B02-GOM3AC2	2108944

SICK AT A GLANCE

SICK is one of the leading manufacturers of intelligent sensors and sensor solutions for industrial applications. A unique range of products and services creates the perfect basis for controlling processes securely and efficiently, protecting individuals from accidents and preventing damage to the environment.

We have extensive experience in a wide range of industries and understand their processes and requirements. With intelligent sensors, we can deliver exactly what our customers need. In application centers in Europe, Asia and North America, system solutions are tested and optimized in accordance with customer specifications. All this makes us a reliable supplier and development partner.

Comprehensive services complete our offering: SICK LifeTime Services provide support throughout the machine life cycle and ensure safety and productivity.

For us, that is “Sensor Intelligence.”

WORLDWIDE PRESENCE:

Contacts and other locations –www.sick.com