



# RFU630-04102

RFU63x

RFID

**SICK**  
Sensor Intelligence.



### Ordering information

Type	part no.
RFU630-04102	1073376

Other models and accessories → [www.sick.com/RFU63x](http://www.sick.com/RFU63x)



### Detailed technical data

#### Features

<b>Version</b>	Long Range
<b>Product category</b>	RFID read/write device without integrated antenna
<b>Radio approval</b>	Australia (AS/NZ4268)
<b>Frequency band</b>	UHF (860 MHz ... 960 MHz)
<b>Carrier frequency</b>	920.25 MHz ... 925.75 MHz
<b>Output power</b>	30 dBm at external antenna ports, output power adjustable
<b>RFID standard</b>	EPCglobal UHF Class 1 Generation 2, ISO/IEC 18000-6 C, RAIN
<b>Modulation</b>	PR-ASK, DSB-ASK
<b>Reading range</b>	≤ 10 m <sup>1)</sup>
<b>Antenna</b>	Not integrated
Connection of external antennas	4 (Up to + 30 dBm, can be adjusted separately)
<b>Bulk reading</b>	✓
<b>Further functions</b>	Diagnosis, updatable firmware, freely programmable data output format, Heartbeat, triggering, SICK AppSpace functionalities can be enabled with the SD card accessory SDK6U-P00100 (for firmware ≥ 2.0.0)

<sup>1)</sup> Depending on transponder used and ambient conditions.

#### Mechanics/electronics

<b>Connection type</b>	1 x M12, 17-pin male connector, A-coded 1 x M12, 4-pin female connector, D-coded 1 x USB, 5-pin micro-B socket
<b>Supply voltage</b>	18 V DC ... 30 V DC
<b>Power consumption</b>	Typ. 20 W

<b>Housing material</b>	Aluminum die cast
<b>Housing color</b>	Blue, black, silver
<b>Enclosure rating</b>	IP67
<b>Protection class</b>	III
<b>Weight</b>	2.1 kg
<b>Dimensions (L x W x H)</b>	239 mm x 197 mm x 40 mm
<b>MTBF</b>	> 100 years

## Interfaces

<b>Ethernet</b>	✓ , TCP/IP, OPC UA
Remark	Companion Spec V1.0 from firmware 2.20
Function	Data interface (read result output), Service interface
Data transmission rate	10/100 MBit/s
<b>PROFINET</b>	✓
Function	PROFINET Single Port, PROFINET Dual Port (optional via external connection module CDF600-2), Data interface (read result output)
Data transmission rate	10/100 MBit/s
<b>EtherNet/IP™</b>	✓
Function	Data interface (read result output)
Data transmission rate	10/100 MBit/s
<b>EtherCAT®</b>	✓
Type of fieldbus integration	Optional over external fieldbus module CDF600
Function	Data interface (read result output)
<b>Serial</b>	✓ , RS-232, RS-422
Remark	RS-422 only via 4-wire
Function	Data interface (read result output), Service interface
Data transmission rate	0.3 kBaud ... 115.2 kBaud, AUX: 57.6 kBaud
<b>CAN</b>	✓
Remark	CSN (SICK CAN Sensor Network)
Function	Data interface (read result output)
<b>PROFIBUS DP</b>	✓
Type of fieldbus integration	Optional over external fieldbus module CDF600-2
Function	Data interface (read result output)
<b>USB</b>	✓
Remark	USB 2.0
Function	Service interface
<b>CANopen</b>	✓
Function	Data interface (read result output)
<b>Digital inputs</b>	2 (physical, 2 additional logical inputs via optional CMC600 parameter memory in CD-B620 / CDM420)
<b>Digital outputs</b>	2 (physical, 2 additional logical outputs via optional CMC600 parameter memory in CD-B620 / CDM420)
<b>Optical indicators</b>	7 LEDs, multi-color (device status)

<sup>1)</sup> Another alternative is to generate your own configuration tools based on the SICK command language CoLa (e.g. in your own software or on PLC function blocks).

	1 RGB LED (Process feedback)
<b>Acoustic indicators</b>	1 beeper (Feedback)
<b>Control elements</b>	2 buttons (choose and start/stop functions)
<b>Operator interfaces</b>	Web server
<b>Configuration software</b>	SOPAS ET <sup>1)</sup>
<b>Programming interface</b>	Application-specific programming using the SICK AppStudio development environment
<b>Memory card</b>	microSD memory card (parameter cloning, data storage)

<sup>1)</sup> Another alternative is to generate your own configuration tools based on the SICK command language CoLa (e.g. in your own software or on PLC function blocks).

## Ambient data

<b>Electromagnetic compatibility (EMC)</b>	EN 301489-3 / EN 50121-4 (2017)
<b>Vibration resistance</b>	EN 60068-2-64:2008-02
<b>Shock resistance</b>	EN 60068-2-27:2009-05
<b>Ambient operating temperature</b>	-30 °C ... +60 °C <sup>1)</sup>
<b>Storage temperature</b>	-30 °C ... +70 °C
<b>Relative humidity</b>	± 90 %, Non-condensing

<sup>1)</sup> From Firmware version V2.02.

## Certificates

<b>ACMA declaration of conformity</b>	✓
<b>China RoHS</b>	✓
<b>Profinet certificate</b>	✓
<b>Ethernet/IP certificate</b>	✓
<b>4Dpro</b>	✓
<b>RAIN RFID</b>	✓

## Classifications

<b>ECLASS 5.0</b>	27280401
<b>ECLASS 5.1.4</b>	27280401
<b>ECLASS 6.0</b>	27280401
<b>ECLASS 6.2</b>	27280401
<b>ECLASS 7.0</b>	27280401
<b>ECLASS 8.0</b>	27280401
<b>ECLASS 8.1</b>	27280401
<b>ECLASS 9.0</b>	27280401
<b>ECLASS 10.0</b>	27280401
<b>ECLASS 11.0</b>	27280401
<b>ECLASS 12.0</b>	27280401
<b>ETIM 5.0</b>	EC002998
<b>ETIM 6.0</b>	EC002998
<b>ETIM 7.0</b>	EC002998
<b>ETIM 8.0</b>	EC002998
<b>UNSPSC 16.0901</b>	52161523

## Dimensional drawing

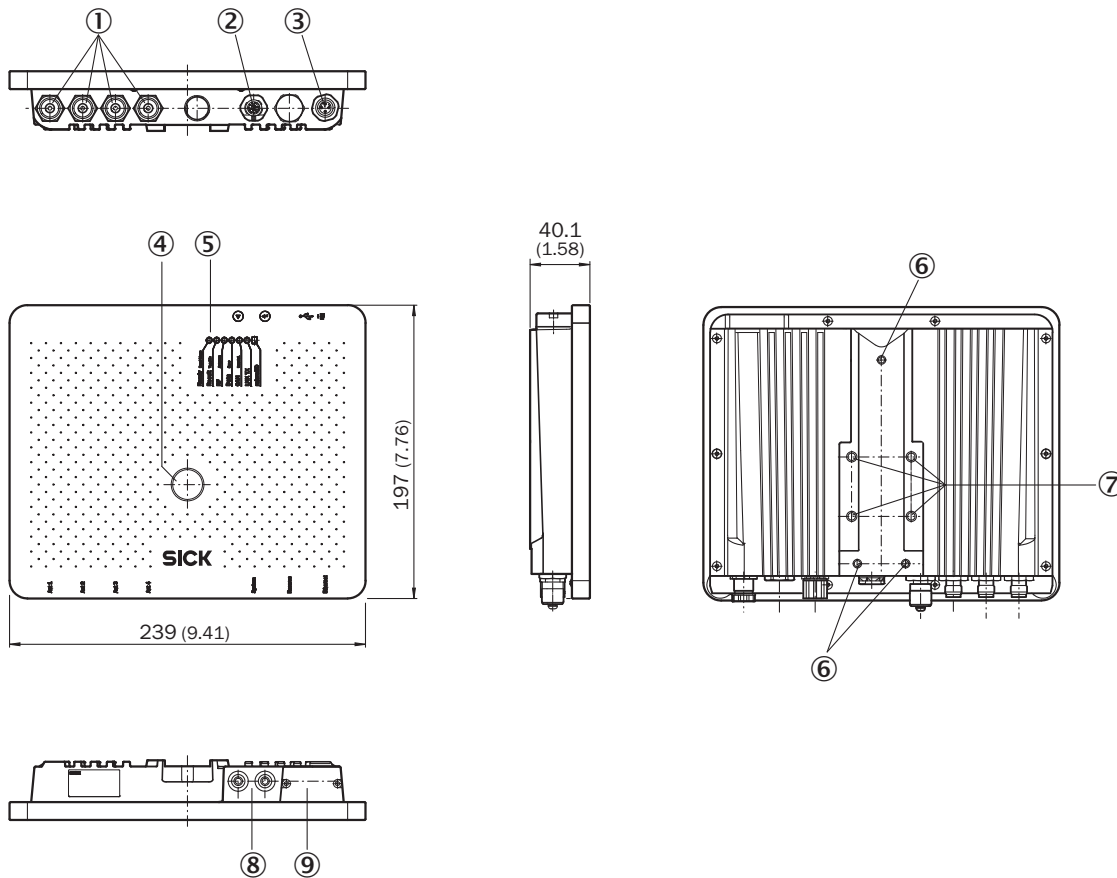

Dimensions in mm (inch)

- ① 4 x antenna input ("external", TNC plug, reverse)
- ② "Power/Serial Data/CAN/I/O" connection
- ③ Ethernet connection
- ④ 1 x LED, multi-colored (process feedback)
- ⑤ 7 x LED for status display
- ⑥ 3 x M5 threaded mounting holes, 8 mm deep
- ⑦ 4 x M6 threaded mounting holes, 11 mm deep
- ⑧ Function buttons
- ⑨ micro-USB female connector and slot for microSD memory card, behind screw-mounted cover

### Connection diagram EtherCAT®

EtherCAT®



- Connecting cable (already present on device)
- EtherCAT® cable, 2 m (Part no. 2106159)

Connection diagram PROFINET IO/RT

PROFINET



- Connecting cable (already present on device)
- Connection cable, 2 m (Part no. 6061702)
- PROFINET cable, 2 m (Part no. 2106182)
- - - PROFINET cable, 2 m (Part no. 2106258)
- · · · PROFINET cable, ready to assemble AIDA plug connectors

### System construction





#### RFU63x







Car body identification in bodyshell construction

### Recommended accessories

Other models and accessories → [www.sick.com/RFU63x](http://www.sick.com/RFU63x)

	Brief description	Type	part no.
<b>Storage media</b>			
	<ul style="list-style-type: none"> <li><b>Description:</b> microSD memory card with 1 GB for industrial use</li> </ul>	microSD memory card	4051366
<b>Mounting systems</b>			
	<ul style="list-style-type: none"> <li><b>Description:</b> Mounting bracket for wall mounting, incl. assembly material</li> </ul>	Mounting bracket	2060912
	<ul style="list-style-type: none"> <li><b>Description:</b> Pivot mounting bracket, incl. assembly material</li> <li><b>Suitable for:</b> Pivot mounting bracket incl. mounting material, can be adjusted +/-30°. Device can be replaced without the need to mechanically readjust the bracket.</li> </ul>	Mounting bracket	2080967

	Brief description	Type	part no.
connectors and cables			
	<ul style="list-style-type: none"> <li>• <b>Description:</b> USB 2.0, unshielded</li> <li>• <b>Connection type head A:</b> Male connector, Micro-B, 4-pin, straight</li> <li>• <b>Connection type head B:</b> Male connector, USB-A, 4-pin, straight</li> <li>• <b>Signal type:</b> USB 2.0</li> <li>• <b>Cable:</b> 2 m, 4-wire</li> </ul>	YMUSA4-020VG4MUIA4	6036106
	<ul style="list-style-type: none"> <li>• <b>Description:</b> Power, suitable for 2 A, shielded, Serial, CAN, Digital I/Os</li> <li>• <b>Connection type head A:</b> Female connector, M12, 17-pin, straight, A-coded</li> <li>• <b>Connection type head B:</b> Male connector, M12, 17-pin, straight, A-coded</li> <li>• <b>Signal type:</b> Power, serial, CAN, digital I/Os</li> <li>• <b>Cable:</b> 0.9 m, 17-wire</li> <li>• <b>Application:</b> Drag chain operation</li> </ul>	YM2A8D-C90XXXF2A8D	6052945
	<ul style="list-style-type: none"> <li>• <b>Connection type head A:</b> Male connector, M12, 4-pin, straight, D-coded</li> <li>• <b>Connection type head B:</b> Male connector, RJ45, 4-pin, straight</li> <li>• <b>Signal type:</b> Ethernet, PROFINET</li> <li>• <b>Cable:</b> 2 m, 4-wire, PUR, halogen-free</li> <li>• <b>Description:</b> Ethernet, shielded, PROFINET</li> <li>• <b>Application:</b> Drag chain operation, Zones with oils and lubricants</li> </ul>	YM2D24-020P-N1MRJA4	2106182
Junction boxes			
		CDB650-204	1064114
RFID transponders			
	<ul style="list-style-type: none"> <li>• <b>Carrier frequency:</b> 865 MHz ... 928 MHz</li> <li>• <b>Memory capacity (EPC / user memory):</b> 496/128 Bit (EPC / User Memory)</li> <li>• <b>Dimensions (L x W x H):</b> 18 mm x 122 mm x 2 mm</li> </ul>	UHF Transponder, Rectangular, global	6088050

## SICK AT A GLANCE

SICK is one of the leading manufacturers of intelligent sensors and sensor solutions for industrial applications. A unique range of products and services creates the perfect basis for controlling processes securely and efficiently, protecting individuals from accidents and preventing damage to the environment.

We have extensive experience in a wide range of industries and understand their processes and requirements. With intelligent sensors, we can deliver exactly what our customers need. In application centers in Europe, Asia and North America, system solutions are tested and optimized in accordance with customer specifications. All this makes us a reliable supplier and development partner.

Comprehensive services complete our offering: SICK LifeTime Services provide support throughout the machine life cycle and ensure safety and productivity.

For us, that is “Sensor Intelligence.”

## WORLDWIDE PRESENCE:

Contacts and other locations –[www.sick.com](http://www.sick.com)