



DBS60E-S1CA04096

DBS60

INCREMENTAL ENCODERS

SICK
Sensor Intelligence.



Illustration may differ



Ordering information

Type	part no.
DBS60E-S1CA04096	1073192

Other models and accessories → www.sick.com/DBS60

Detailed technical data

Safety-related parameters

MTTF_D (mean time to dangerous failure)	500 years (EN ISO 13849-1) ¹⁾
--	--

¹⁾ This product is a standard product and does not constitute a safety component as defined in the Machinery Directive. Calculation based on nominal load of components, average ambient temperature 40 °C, frequency of use 8760 h/a. All electronic failures are considered hazardous. For more information, see document no. 8015532.

Performance

Pulses per revolution	4,096
Measuring step	≤ 90°, electric/pulses per revolution
Measuring step deviation	± 36° / pulses per revolution
Error limits	Measuring step deviation x 3
Duty cycle	≤ 0.5 ± 10 %

Interfaces

Communication interface	Incremental
Communication Interface detail	TTL / RS-422
Number of signal channels	6-channel
Initialization time	< 5 ms ¹⁾
Output frequency	+ 300 kHz ²⁾
Load current	≤ 30 mA, per channel
Power consumption	≤ 0.5 W (without load)

¹⁾ Valid signals can be read once this time has elapsed.

²⁾ Up to 450 kHz on request.

Electronics

Connection type	Male connector, M23, 12-pin, radial
------------------------	-------------------------------------

¹⁾ Short-circuit opposite to another channel or GND permissible for max. 60 s. No protection signal against U_S.

Supply voltage	10 ... 30 V
Reference signal, number	1
Reference signal, position	90°, electric, logically gated with A and B
Reverse polarity protection	✓
Short-circuit protection of the outputs	✓ ¹⁾

¹⁾ Short-circuit opposite to another channel or GND permissible for max. 60 s. No protection signal against U_S.

Mechanics

Mechanical design	Solid shaft, Servo flange
Shaft diameter	6 mm With flat
Shaft length	10 mm
Flange type / stator coupling	Flange with 3 x M3 and 3 x M4
Weight	+ 0.3 kg ¹⁾
Shaft material	Stainless steel
Flange material	Aluminum
Housing material	Aluminum
Start up torque	+ 1.2 Ncm (+20 °C)
Operating torque	1.1 Ncm (+20 °C)
Permissible shaft loading	100 N (radial) ²⁾ 50 N (axial) ²⁾
Operating speed	6,000 min ⁻¹ ³⁾
Maximum operating speed	9,000 min ⁻¹ ⁴⁾
Moment of inertia of the rotor	33 gcm ²
Bearing lifetime	3.6 x 10 ⁹ revolutions
Angular acceleration	≤ 500,000 rad/s ²

¹⁾ Based on encoder with male connector or cable with male connector.

²⁾ Higher values are possible using limited bearing life.

³⁾ Allow for self-heating of 3.2 K per 1,000 rpm when designing the operating temperature range.

⁴⁾ Maximum speed which does not cause mechanical damage to the encoder. Impact on the service life and signal quality is possible. Please note the maximum output frequency.

Ambient data

EMC	According to EN 61000-6-2 and EN 61000-6-3
Enclosure rating	IP67, housing side (IEC 60529) ¹⁾ IP65, shaft side (IEC 60529)
Permissible relative humidity	90 % (Condensation not permitted)
Operating temperature range	-30 °C ... +85 °C, at more than 3,000 pulses per revolution ²⁾
Storage temperature range	-40 °C ... +100 °C, without package
Resistance to shocks	250 g, 3 ms (EN 60068-2-27)
Resistance to vibration	30 g, 10 Hz ... 2,000 Hz (EN 60068-2-6)

¹⁾ With mating connector fitted.

²⁾ These values relate to all mechanical versions including recommended accessories unless otherwise noted.

Certificates

EU declaration of conformity	✓
UK declaration of conformity	✓
ACMA declaration of conformity	✓
China RoHS	✓
cRUus certificate	✓
Information according to Art. 3 of Data Act (Regulation EU 2023/2854)	✓

Classifications

ECLASS 5.0	27270501
ECLASS 5.1.4	27270501
ECLASS 6.0	27270590
ECLASS 6.2	27270590
ECLASS 7.0	27270501
ECLASS 8.0	27270501
ECLASS 8.1	27270501
ECLASS 9.0	27270501
ECLASS 10.0	27270501
ECLASS 11.0	27270501
ECLASS 12.0	27270501
ETIM 5.0	EC001486
ETIM 6.0	EC001486
ETIM 7.0	EC001486
ETIM 8.0	EC001486
UNSPSC 16.0901	41112113

Dimensional drawing



Dimensions in mm (inch)

- ① Zero pulse mark on housing
- ② Zero pulse mark on flange
- ③ depth
- ④ male connector tolerance in relation to hole pattern

Attachment specifications Mounting requirements for small servo clamp



All dimensions in mm (inch)

Attachment specifications Mounting requirements for half-shell servo clamp

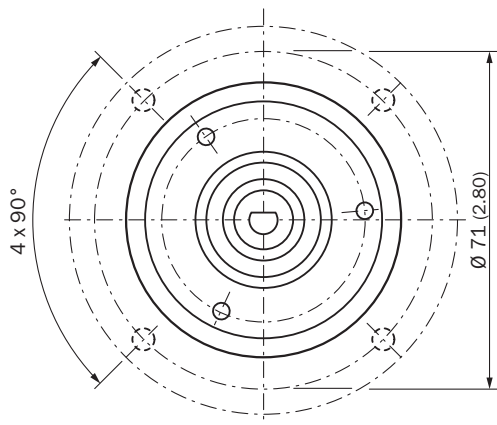

All dimensions in mm (inch)

PIN assignment

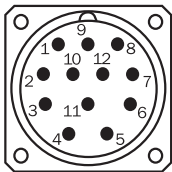

view of M23 male device connector on cable / housing

Wire colors (cable connection)	Male connector M12, 8-pin	Male connector M23, 12-pin	TTL/HTL 6-channel signal	Explanation
Brown	1	6	A-	Signal wire
White	2	5	A	Signal wire
Black	3	1	B-	Signal wire
Pink	4	8	B	Signal wire
Yellow	5	4	Z-	Signal wire
Purple	6	3	Z	Signal wire
Blue	7	10	GND	Ground connection
Red	8	12	+U _s	Supply voltage
-	-	9	Not assigned	Not assigned
-	-	2	Not assigned	Not assigned
-	-	11	Not assigned	Not assigned
-	-	7	Not assigned	Not assigned
Screen	Screen	Screen	Screen	Screen connected to encoder housing

Diagrams

Pulses per revolution



Diagrams Signal outputs for electrical interfaces TTL and HTL



Cw with view on the encoder shaft in direction "A", compare dimensional drawing.







Supply voltage	Output
4,5 V ... 5,5 V	TTL
10 V ... 30 V	TTL
10 V ... 27 V	HTL







Supply voltage	Output
4,5 V ... 30 V	TTL/HTL universal
4,5 V ... 30 V	TTL



Recommended accessories

Other models and accessories → www.sick.com/DBS60

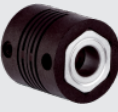
	Brief description	Type	part no.
connectors and cables			
	<ul style="list-style-type: none"> Description: SSI, shielded, Incremental, HIPERFACE® Connection type head A: Flying leads Connection type head B: Flying leads Signal type: SSI, Incremental, HIPERFACE® Items supplied: By the meter Cable: 8-wire, PUR, halogen-free 	LTG-2308-MWENC	6027529
	<ul style="list-style-type: none"> Description: SSI, shielded, Incremental Connection type head A: Flying leads Connection type head B: Flying leads Signal type: SSI, Incremental Items supplied: By the meter Cable: 11-wire, PUR 	LTG-2411-MW	6027530
	<ul style="list-style-type: none"> Description: SSI, shielded, Incremental Connection type head A: Flying leads Connection type head B: Flying leads Signal type: SSI, Incremental Items supplied: By the meter Cable: 12-wire, PUR, halogen-free 	LTG-2512-MW	6027531
	<ul style="list-style-type: none"> Description: SSI, shielded, TTL, HTL, Incremental Connection type head A: Flying leads Connection type head B: Flying leads Signal type: SSI, TTL, HTL, Incremental Items supplied: By the meter Cable: 12-wire, UV and saltwater-resistant, PUR, halogen-free 	LTG-2612-MW	6028516
	<ul style="list-style-type: none"> Description: Incremental, shielded Connection type head A: Female connector, M23, 12-pin, straight Connection type head B: Flying leads Signal type: Incremental Cable: 30 m, 11-wire, PUR Application: Zones with oils and lubricants 	DOL-2312-G30MLA3	2030702
	<ul style="list-style-type: none"> Description: Incremental, shielded Connection type head A: Female connector, M23, 12-pin, straight Connection type head B: Flying leads Signal type: Incremental Cable: 25 m, 11-wire, PUR Application: Zones with oils and lubricants 	DOL-2312-G25MLA3	2030699
	<ul style="list-style-type: none"> Description: Incremental, shielded Connection type head A: Female connector, M23, 12-pin, straight Connection type head B: Flying leads Signal type: Incremental Cable: 20 m, 11-wire, PUR Application: Zones with oils and lubricants 	DOL-2312-G20MLA3	2030695
	<ul style="list-style-type: none"> Description: Incremental, shielded Connection type head A: Female connector, M23, 12-pin, straight Connection type head B: Flying leads Signal type: Incremental Cable: 15 m, 11-wire, PUR Application: Zones with oils and lubricants 	DOL-2312-G15MLA3	2030692
	<ul style="list-style-type: none"> Description: Incremental, shielded Connection type head A: Female connector, M23, 12-pin, straight Connection type head B: Flying leads Signal type: Incremental Cable: 10 m, 11-wire, PUR Application: Zones with oils and lubricants 	DOL-2312-G10MLA3	2030688
	<ul style="list-style-type: none"> Description: Incremental, shielded Connection type head A: Female connector, M23, 12-pin, straight Connection type head B: Flying leads Signal type: Incremental Cable: 7 m, 11-wire, PUR Application: Zones with oils and lubricants 	DOL-2312-G07MLA3	2030685
	<ul style="list-style-type: none"> Description: Incremental, shielded Connection type head A: Female connector, M23, 12-pin, straight Connection type head B: Flying leads Signal type: Incremental 	DOL-2312-G02MLA3	2030682

	Brief description	Type	part no.
	<ul style="list-style-type: none"> Cable: 2 m, 11-wire, PUR Application: Zones with oils and lubricants 		
	<ul style="list-style-type: none"> Description: HIPERFACE[®], shielded, SSI, Incremental Connection type head A: Female connector, M23, 12-pin, angled, A-coded Signal type: HIPERFACE[®], SSI, Incremental Connection systems: Solder connection 	DOS-2312-W01	2072580
	<ul style="list-style-type: none"> Description: HIPERFACE[®], shielded, SSI, Incremental Connection type head A: Female connector, M23, 12-pin, straight, A-coded Signal type: HIPERFACE[®], SSI, Incremental Connection systems: Solder connection 	DOS-2312-G02	2077057
Mounting systems			
	<ul style="list-style-type: none"> Description: Bearing block for servo and face mount flange encoder. The heavy-duty bearing block is used to absorb very large radial and axial shaft loads. Particularly when using belt pulleys, chain sprockets, friction wheels. Operating speed max. 4,000 rpm⁻¹, axial shaft load 150 N, radial shaft load 250 N, bearing service life 3.6 x 10⁹ revolutions 	BEF-FA-LB1210	2044591
	<ul style="list-style-type: none"> Description: Mounting kit for servo flange encoder on the bearing block, 1 bar coupling SKPS 1520 06/06 1 hexagon socket wrench SW1.5 DIN 911, 3 mounting eccentric BEMN 1242 49 3 screws M4 x 10 DIN 912, 1 hexagon socket wrench SW3 DIN 911 Items supplied: 1 bar coupling SKPS 1520 06/06 1 hexagon socket wrench SW1.5 DIN 911, 3 mounting eccentric BEMN 1242 49 3 screws M4 x 10 DIN 912, 1 hexagon socket wrench SW3 DIN 911 	BEF-MK-LB	5320872
	<ul style="list-style-type: none"> Description: Mounting bell for encoder with servo flange, 50 mm spigot Items supplied: Mounting kit included 	BEF-MG-50	5312987
	<ul style="list-style-type: none"> Description: Half-shell servo clamps (2 pcs.) for servo flanges with a 50 mm centering hub 	BEF-WG-SF050	2029165
	<ul style="list-style-type: none"> Description: Servo clamps, large, for servo flange (clamps, eccentric fastener), 3 pcs, without mounting material Items supplied: Without mounting hardware 	BEF-WK-SF	2029166

	Brief description	Type	part no.
shaft adaptation			
	<ul style="list-style-type: none"> • Product segment: Shaft adaptation • Product: Shaft couplings • Description: Bellows coupling, shaft diameter 6 mm / 10 mm, maximum shaft offset: radial ± 0.25 mm, axial ± 0.4 mm, angular $\pm 4^\circ$; max. speed 10,000 rpm, -30°C to $+120^\circ\text{C}$, max. torque 120 Ncm; material: stainless steel bellows, aluminum hub 	KUP-0610-B	5312982
	<ul style="list-style-type: none"> • Product segment: Shaft adaptation • Product: Shaft couplings • Description: Spring washer coupling, shaft diameter 6 mm / 10 mm, Maximum shaft offset: radial ± 0.3 mm, axial ± 0.4 mm, angular $\pm 2.5^\circ$; max. speed 12,000 rpm, -10° to $+80^\circ\text{C}$, max. torque 60 Ncm; material: aluminum flange, glass fiber-reinforced polyamide membrane and hardened steel coupling pin 	KUP-0610-F	5312985
	<ul style="list-style-type: none"> • Product segment: Shaft adaptation • Product: Shaft couplings • Description: Double loop coupling, shaft diameter 6 mm / 10 mm, max. shaft offset: radially ± 2.5 mm, axially ± 3 mm, angle ± 10 degrees; max. speed 3,000 rpm, -30 to $+80$ degrees Celsius, torsional spring stiffness of 25 Nm/rad 	KUP-0610-D	5326697
	<ul style="list-style-type: none"> • Product segment: Shaft adaptation • Product: Shaft couplings • Description: Bar coupling, shaft diameter 6 mm / 10 mm, max. shaft offset: radial ± 0.3 mm, axial ± 0.3 mm, angular $\pm 3^\circ$; max. speed 10,000 rpm, -10° to $+80^\circ\text{C}$, max. torque: 80 Ncm, material: fiber-glass reinforced polyamide, aluminum hub 	KUP-0610-S	2056407
	<ul style="list-style-type: none"> • Product segment: Shaft adaptation • Product: Shaft couplings • Description: Claw coupling, shaft diameter 6 mm / 10 mm, damping element 80 shore blue, maximum shaft offset: radial ± 0.22 mm, axial ± 1 mm angular $\pm 1.3^\circ$, max. speed 19,000 rpm, angle of twist max. 10°, -30°C to $+80^\circ\text{C}$, max. torque 800 Ncm, tightening torque of screws: ISO 4029 150 Ncm, material: aluminum flange, damping element: polyurethane 	KUP-0610-J	2127056
	<ul style="list-style-type: none"> • Product segment: Shaft adaptation • Product: Shaft couplings • Description: Bar coupling, shaft diameter 6 mm / 8 mm, maximum shaft offset radial ± 0.3 mm, axial ± 0.2 mm, angle $\pm 3^\circ$, max. speed 10,000 rpm, torsion spring rigidity 38 Nm/wheel; material: fiber-glass reinforced polyamide, aluminum hub 	KUP-0608-S	5314179
	<ul style="list-style-type: none"> • Product segment: Shaft adaptation • Product: Shaft couplings • Description: Cross-slotted coupling, shaft diameter 6 mm / 6 mm, maximum shaft offset: radial ± 0.3 mm, axial ± 0.2 mm, angle $\pm 3^\circ$; max. speed 10,000 rpm, -10° to $+80^\circ\text{C}$, max. torque 80 Ncm; material: fiber-glass reinforced polyamide, aluminum hub 	KUP-0606-S	2056406
	<ul style="list-style-type: none"> • Product segment: Shaft adaptation • Product: Shaft couplings • Description: Bellows coupling, shaft diameter 6 mm / 6 mm, maximum shaft offset: radial ± 0.25 mm, axial ± 0.4 mm, angular $\pm 4^\circ$; max. speed 10,000 rpm, -30°C to $+120^\circ\text{C}$, max. torque 120 Ncm; material: stainless steel bellows, aluminum hub 	KUP-0606-B	5312981

	Brief description	Type	part no.
measuring wheels and measuring wheel mechanics			
	<ul style="list-style-type: none"> • Product segment: Measuring wheels and measuring wheel mechanics • Product: Measuring wheel mechanics • Description: O-ring for measuring wheels (circumference 200 mm) 	BEF-OR-053-040	2064061
	<ul style="list-style-type: none"> • Product segment: Measuring wheels and measuring wheel mechanics • Product: Measuring wheel mechanics • Description: O-ring for measuring wheels (circumference 300 mm) • Items supplied: 2x O-ring 	BEF-OR-083-050	2064076
	<ul style="list-style-type: none"> • Product segment: Measuring wheels and measuring wheel mechanics • Product: Measuring wheel mechanics 	BEF-OR-145-050	2064074

	Brief description	Type	part no.
	<ul style="list-style-type: none"> Description: O-ring for measuring wheels (circumference 500 mm) Product segment: Measuring wheels and measuring wheel mechanics Product: Measuring wheels Description: Aluminum measuring wheel with studded polyurethane surface for 6 mm solid shaft, circumference 200 mm 	BEF-MR06200APN	4084747
	<ul style="list-style-type: none"> Product segment: Measuring wheels and measuring wheel mechanics Product: Measuring wheels Description: Aluminum measuring wheel with smooth polyurethane surface for 6 mm solid shaft, circumference 200 mm 	BEF-MR06200AP	4084746
	<ul style="list-style-type: none"> Product segment: Measuring wheels and measuring wheel mechanics Product: Measuring wheels Description: Aluminum measuring wheel with cross-knurled surface for 6 mm solid shaft, circumference 200 mm 	BEF-MR06200AK	4084745
	<ul style="list-style-type: none"> Product segment: Measuring wheels and measuring wheel mechanics Product: Measuring wheels Description: Aluminum measuring wheel with ridged polyurethane surface for 6 mm solid shaft, circumference 200 mm 	BEF-MR06200APG	4084748
	<ul style="list-style-type: none"> Product segment: Measuring wheels and measuring wheel mechanics Product: Measuring wheels Description: Aluminium measuring wheel with O-ring (NBR70) for 6 mm solid shaft, circumference 200 mm 	BEF-MR006020R	2055222
	<ul style="list-style-type: none"> Product segment: Measuring wheels and measuring wheel mechanics Product: Measuring wheels Description: Measuring wheel with O-ring (NBR70) for 6 mm solid shaft, circumference 300 mm 	BEF-MR006030R	2055634
	<ul style="list-style-type: none"> Product segment: Measuring wheels and measuring wheel mechanics Product: Measuring wheels Description: Aluminium measuring wheel with O-ring (NBR70) for 6 mm solid shaft, circumference 500 mm 	BEF-MR006050R	2055225

SICK AT A GLANCE

SICK is one of the leading manufacturers of intelligent sensors and sensor solutions for industrial applications. A unique range of products and services creates the perfect basis for controlling processes securely and efficiently, protecting individuals from accidents and preventing damage to the environment.

We have extensive experience in a wide range of industries and understand their processes and requirements. With intelligent sensors, we can deliver exactly what our customers need. In application centers in Europe, Asia and North America, system solutions are tested and optimized in accordance with customer specifications. All this makes us a reliable supplier and development partner.

Comprehensive services complete our offering: SICK LifeTime Services provide support throughout the machine life cycle and ensure safety and productivity.

For us, that is “Sensor Intelligence.”

WORLDWIDE PRESENCE:

Contacts and other locations –www.sick.com