



LFP1000-B5BMC

LFP Cubic

LEVEL SENSORS

SICK
Sensor Intelligence.



Ordering information

Type	part no.
LFP1000-B5BMC	1071109

Other models and accessories → www.sick.com/LFP_Cubic

Illustration may differ



Detailed technical data

Features

Medium	Fluids
Measurement	Switch, Continuous
Design	Remote amplifier
Probe type	Rod probe
Probe length	1,000 mm
Process pressure	-1 bar ... 10 bar
Process temperature	-20 °C ... +100 °C

Performance

Accuracy of sensor element	± 5 mm ¹⁾
Reproducibility	≤ 2 mm
Resolution	< 2 mm
Response time	400 ms
Dielectricity constant	≥ 5 for rod probe / cable probe ≥ 1.8 with coaxial tube
Conductivity	No limitation
Maximum level change	≤ 500 mm/s
Deactivated area at process connection	25 mm ²⁾
Deactivated area at end of probe	≥ 10 mm ¹⁾
MTTF	194.3 years (EN ISO 13849-1)
Display	✓

¹⁾ With water under reference conditions.

²⁾ With parameterized container with water under reference conditions, otherwise 40 mm.

Electronics

Communication interface	IO-Link
Supply voltage	12 V DC ... 30 V DC ¹⁾
Power consumption	≤ 100 mA at 24 V DC without output load
Initialization time	≤ 5 s
Protection class	III
Connection type	M12 round connector x 1, 8-pin
Length of cable	1 m
Output signal	1 x PNP + 3 x PNP/NPN + 4 mA ... 20 mA / 0 V ... 10 V
Output load	4 mA ... 20 mA < 350 Ohm at U _v > 12 V, 0 V ... 10 V > 750 Ohm at U _v 14 ≥ V
Hysteresis	≥ 2 mm ²⁾
Output current	< 100 mA
Inductive load	< 1 H
Capacitive load	100 nF
Enclosure rating	IP67 (EN 60529)
Temperature drift	< 0.1 mm/K
Lower signal level	3.8 mA ... 4 mA
Upper signal level	20 mA ... 20.5 mA
EMC	EN 61326-2-3, 2014/30/EU

¹⁾ All connections are polarity protected. All outputs are overload and short-circuit protected.

²⁾ Freely adjustable.

Mechanics

Wetted parts	Stainless steel 1.4404 / 316L PTFE FKM
Process connection	¾" NPT
Housing material	Plastic PBT
Max. probe load	≤ 6 Nm
Material coaxial cable	PVC

Ambient data

Ambient operating temperature	-20 °C ... +60 °C
Ambient temperature, storage	-40 °C ... +80 °C
Ambient temperature coaxial cable	-20 °C ... +60 °C

Certificates

EU declaration of conformity	✓
UK declaration of conformity	✓
ACMA declaration of conformity	✓
Moroccan declaration of conformity	✓
China RoHS	✓
cULus certificate	✓
IO-Link certificate	✓

Information according to Art. 3 of Data Act (Regulation EU 2023/2854)

✓

Classifications

ECLASS 5.0	27200513
ECLASS 5.1.4	27200513
ECLASS 6.0	27200513
ECLASS 6.2	27200513
ECLASS 7.0	27200513
ECLASS 8.0	27200513
ECLASS 8.1	27200513
ECLASS 9.0	27200513
ECLASS 10.0	27200513
ECLASS 11.0	27200513
ECLASS 12.0	27200513
ETIM 5.0	EC001447
ETIM 6.0	EC001447
ETIM 7.0	EC001447
ETIM 8.0	EC001447
UNSPSC 16.0901	41113710

Connection type

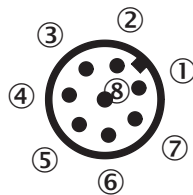
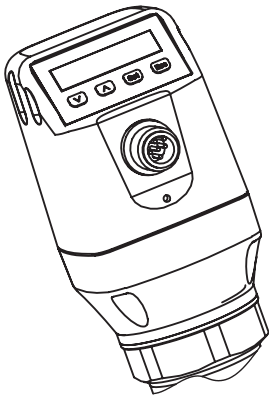

- ① L⁺: Supply voltage
- ② Q₂: Switching output 2, PNP/NPN
- ③ M: Ground, reference ground for current-/voltage output
- ④ C/Q₁: Switching output 1, PNP/IO-Link-communication
- ⑤ Q₃: Switching output 3, PNP/NPN
- ⑥ Q₄: Switching output 4, PNP/NPN
- ⑦ Q_A: Analog current-/voltage output
- ⑧ No function

Instruction for installation

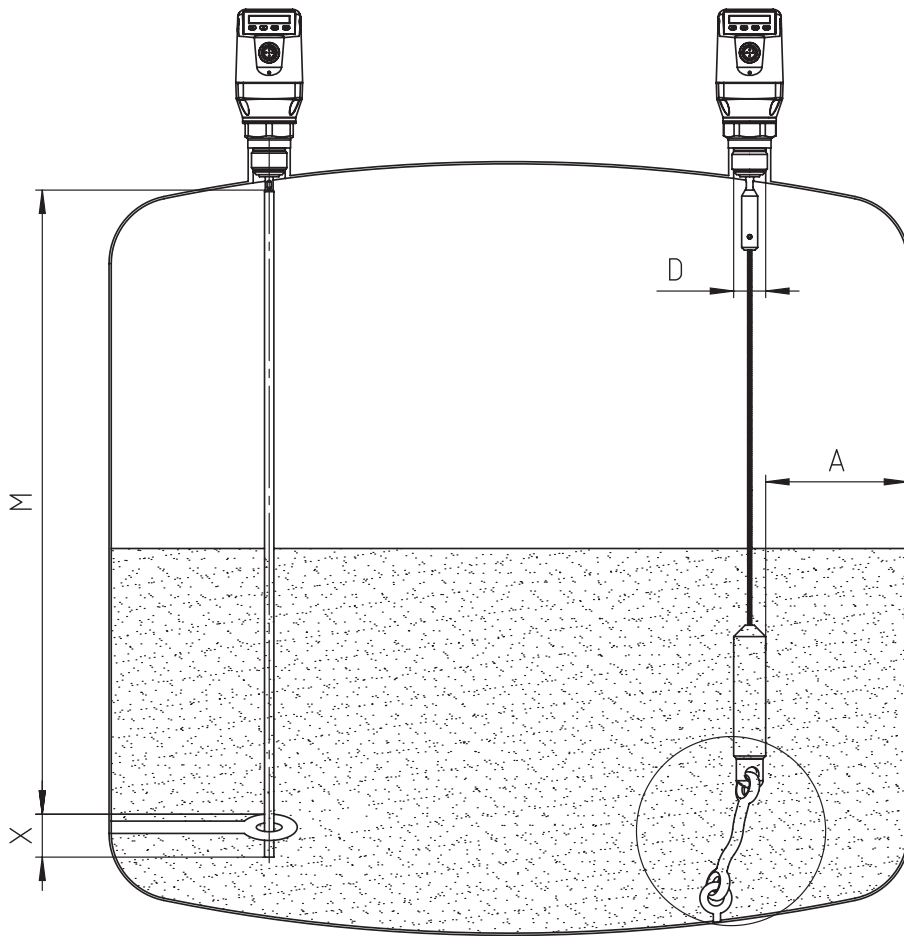

Mono rod probe mounted in metal tank

M = Measuring range
 X = Inactive area at probe end
 No measurement possible

Rope probe mounted in metal tank

Installation in nozzle:
 $D \geq \text{DN } 25 \text{ (1")}$
 Distance tank wall/tank bottom:
 $A \geq 50 \text{ mm (1.97")}$
 Distance to other tank fittings:
 $\geq 100 \text{ mm (3.94")}$

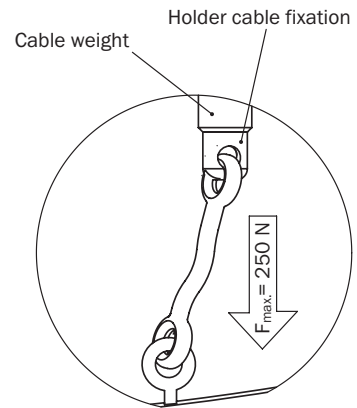

Instruction for installation Installation in a metal immersion tube or metal bypass



Instruction for installation Installation in a metal tank

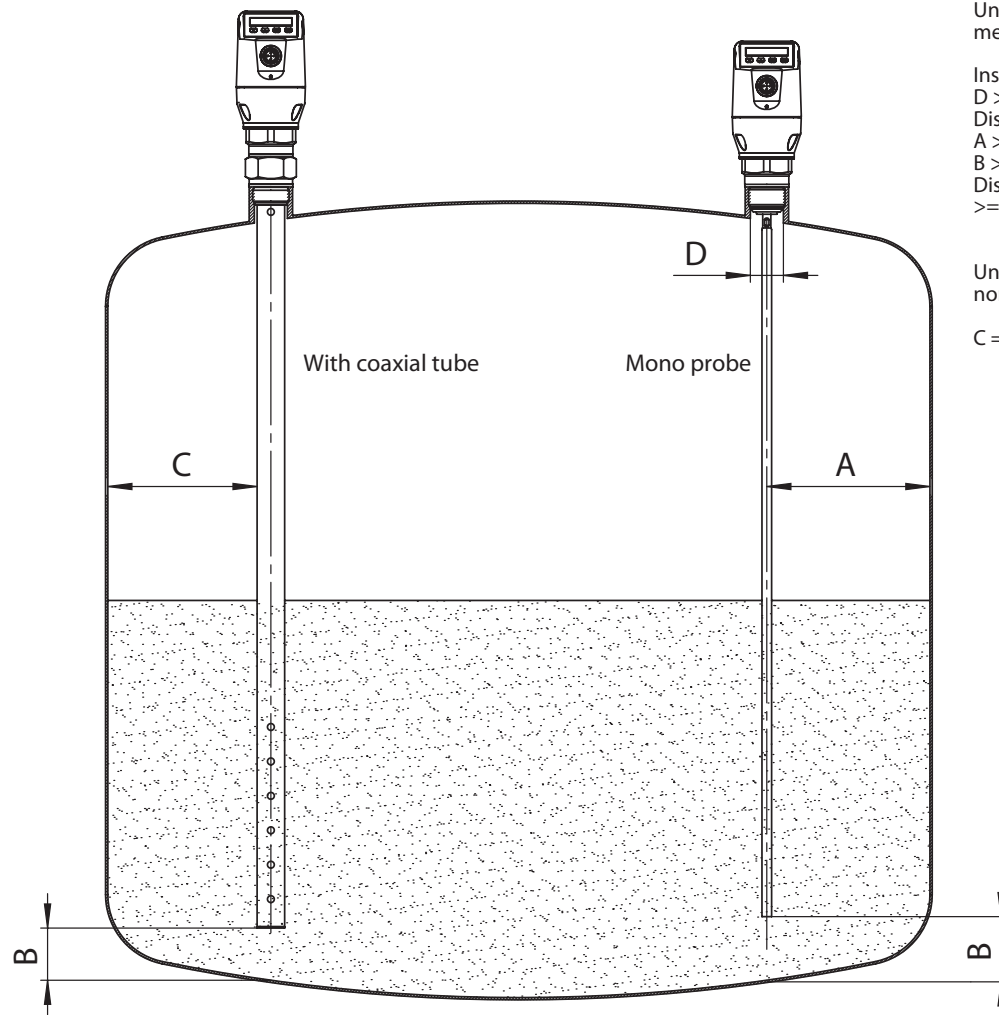

Unit with mono probe mounted in metal tank

Installation in nozzle:

$D \geq DN 25 (1")$

Distance tank wall/tank bottom:

$A \geq 50 \text{ mm } (1.97")$

$B \geq 10 \text{ mm } (0.40")$

Distance to other tank fittings

$\geq 100 \text{ mm } (3.94")$

Unit with coaxial tube for metal and non metal tank

C = with a coaxial tube there are no minimum distances to the tank wall or to other tank fittings required



Recommended accessories

Other models and accessories → www.sick.com/LFP_Cubic

	Brief description	Type	part no.
Mounting systems			
	<ul style="list-style-type: none"> Description: Mounting bracket Material: Stainless steel Details: Stainless steel 1.4301 (AISI 304) Items supplied: Mounting hardware included 	BEF-FL-304LFP-HLDR	2077391
	<ul style="list-style-type: none"> Description: Spare probe for LFP Cubic, probe length 1000 mm, material 1.4404/316L, diameter 7 mm 	BEF-ER-SN1000-LFPC	2065700
	<ul style="list-style-type: none"> Description: Spare probe for LFP Cubic, probe length 2000 mm, material 1.4404/316L, diameter 7 mm 	BEF-ER-SN2000-LFPC	2065701

	Brief description	Type	part no.
connectors and cables			
	<ul style="list-style-type: none"> Description: Sensor/actuator cable, shielded Connection type head A: Female connector, M12, 8-pin, straight, A-coded Connection type head B: Flying leads Signal type: Sensor/actuator cable Cable: 2 m, 8-wire, PVC Application: Uncontaminated zones, Zones with chemicals 	YF2A28-020VA6XLEAX	2096243
	<ul style="list-style-type: none"> Description: Sensor/actuator cable, shielded Connection type head A: Female connector, M12, 8-pin, straight, A-coded Connection type head B: Flying leads Signal type: Sensor/actuator cable Cable: 5 m, 8-wire, PVC Application: Uncontaminated zones, Zones with chemicals 	YF2A28-050VA6XLEAX	2096244
	<ul style="list-style-type: none"> Description: Sensor/actuator cable, unshielded Connection type head A: Female connector, M12, 8-pin, straight, A-coded Connection type head B: Flying leads Signal type: Sensor/actuator cable Cable: 2 m, 8-wire, PUR, halogen-free Application: Drag chain operation, Zones with oils and lubricants, Robot, Drag chain operation 	YF2A18-020UA5XLEAX	2095652
	<ul style="list-style-type: none"> Description: Sensor/actuator cable, unshielded Connection type head A: Female connector, M12, 8-pin, straight, A-coded Connection type head B: Flying leads Signal type: Sensor/actuator cable Cable: 5 m, 8-wire, PUR, halogen-free Application: Drag chain operation, Zones with oils and lubricants, Robot, Drag chain operation 	YF2A18-050UA5XLEAX	2095653
	<ul style="list-style-type: none"> Description: Sensor/actuator cable, shielded Connection type head A: Female connector, M12, 8-pin, straight, A-coded Connection type head B: Flying leads Signal type: Sensor/actuator cable Cable: 10 m, 8-wire, PVC Application: Uncontaminated zones, Zones with chemicals 	YF2A28-100VA6XLEAX	2096245
	<ul style="list-style-type: none"> Description: Sensor/actuator cable, unshielded Connection type head A: Female connector, M12, 8-pin, straight, A-coded Connection type head B: Flying leads Signal type: Sensor/actuator cable Cable: 10 m, 8-wire, PUR, halogen-free Application: Drag chain operation, Zones with oils and lubricants, Robot, Drag chain operation 	YF2A18-100UA5XLEAX	2095654
	<ul style="list-style-type: none"> Description: Sensor/actuator cable, shielded Connection type head A: Female connector, M12, 8-pin, angled, A-coded Connection type head B: Flying leads Signal type: Sensor/actuator cable Cable: 2 m, 8-wire, PVC Application: Uncontaminated zones, Zones with chemicals 	YG2A28-020VA6XLEAX	2096218
	<ul style="list-style-type: none"> Description: Sensor/actuator cable, unshielded Connection type head A: Female connector, M12, 8-pin, angled, A-coded Connection type head B: Flying leads Signal type: Sensor/actuator cable Cable: 2 m, 8-wire, PUR, halogen-free Application: Drag chain operation, Zones with oils and lubricants, Robot, Drag chain operation 	YG2A18-020UA5XLEAX	2095779
	<ul style="list-style-type: none"> Description: Sensor/actuator cable, shielded Connection type head A: Female connector, M12, 8-pin, angled, A-coded Connection type head B: Flying leads Signal type: Sensor/actuator cable Cable: 5 m, 8-wire, PVC Application: Uncontaminated zones, Zones with chemicals 	YG2A28-050VA6XLEAX	2096219
	<ul style="list-style-type: none"> Description: Sensor/actuator cable, unshielded Connection type head A: Female connector, M12, 8-pin, angled, A-coded Connection type head B: Flying leads Signal type: Sensor/actuator cable Cable: 5 m, 8-wire, PUR, halogen-free Application: Drag chain operation, Zones with oils and lubricants, Robot, Drag chain operation 	YG2A18-050UA5XLEAX	2095780
	<ul style="list-style-type: none"> Description: Sensor/actuator cable, unshielded Connection type head A: Female connector, M12, 8-pin, angled, A-coded Connection type head B: Flying leads Signal type: Sensor/actuator cable Cable: 10 m, 8-wire, PUR, halogen-free 	YG2A18-100UA5XLEAX	2095781

	Brief description	Type	part no.
	<ul style="list-style-type: none"> Application: Drag chain operation, Zones with oils and lubricants, Robot, Drag chain operation Description: Sensor/actuator cable, shielded Connection type head A: Female connector, M12, 8-pin, angled, A-coded Connection type head B: Flying leads Signal type: Sensor/actuator cable Cable: 0.5 m, 8-wire, PVC Application: Untaminated zones, Zones with chemicals 	YG2A28-C50VA6XLEAX	2145694
	<ul style="list-style-type: none"> Description: Sensor/actuator cable, shielded Connection type head A: Female connector, M12, 8-pin, straight, A-coded Connection type head B: Flying leads Signal type: Sensor/actuator cable Cable: 3 m, 8-wire, PVC Application: Untaminated zones, Zones with chemicals 	YF2A28-030VA6XLEAX	2145695
	<ul style="list-style-type: none"> Description: Sensor/actuator cable, unshielded Connection type head A: Female connector, M12, 8-pin, angled, A-coded Connection type head B: Flying leads Signal type: Sensor/actuator cable Cable: 0.6 m, 8-wire, PUR, halogen-free Application: Drag chain operation, Zones with oils and lubricants, Robot, Drag chain operation 	YG2A18-C60UA5XLEAX	2145381
	<ul style="list-style-type: none"> Description: Sensor/actuator cable, unshielded Connection type head A: Female connector, M12, 8-pin, angled, A-coded Connection type head B: Flying leads Signal type: Sensor/actuator cable Cable: 1 m, 8-wire, PUR, halogen-free Application: Drag chain operation, Zones with oils and lubricants, Robot, Drag chain operation 	YG2A18-010UA5XLEAX	2145382
	<ul style="list-style-type: none"> Description: Sensor/actuator cable, unshielded Connection type head A: Female connector, M12, 8-pin, angled, A-coded Connection type head B: Flying leads Signal type: Sensor/actuator cable Cable: 3 m, 8-wire, PUR, halogen-free Application: Drag chain operation, Zones with oils and lubricants, Robot, Drag chain operation 	YG2A18-030UA5XLEAX	2145383
	<ul style="list-style-type: none"> Description: Sensor/actuator cable, shielded Connection type head A: Female connector, M12, 8-pin, angled, A-coded Connection type head B: Flying leads Signal type: Sensor/actuator cable Cable: 0.6 m, 8-wire, PVC Application: Untaminated zones, Zones with chemicals 	YG2A28-C60VA6XLEAX	2145388
	<ul style="list-style-type: none"> Description: Sensor/actuator cable, shielded Connection type head A: Female connector, M12, 8-pin, angled, A-coded Connection type head B: Flying leads Signal type: Sensor/actuator cable Cable: 1 m, 8-wire, PVC Application: Untaminated zones, Zones with chemicals 	YG2A28-010VA6XLEAX	2145389
	<ul style="list-style-type: none"> Description: Sensor/actuator cable, shielded Connection type head A: Female connector, M12, 8-pin, angled, A-coded Connection type head B: Flying leads Signal type: Sensor/actuator cable Cable: 10 m, 8-wire, PVC Application: Untaminated zones, Zones with chemicals 	YG2A28-100VA6XLEAX	2145391
	<ul style="list-style-type: none"> Description: Sensor/actuator cable, shielded Connection type head A: Female connector, M12, 8-pin, angled, A-coded Connection type head B: Flying leads Signal type: Sensor/actuator cable Cable: 3 m, 8-wire, PVC Application: Untaminated zones, Zones with chemicals 	YG2A28-030VA6XLEAX	2145390
	<ul style="list-style-type: none"> Description: Sensor/actuator cable, shielded Connection type head A: Female connector, M12, 8-pin, straight, A-coded Connection type head B: Flying leads Signal type: Sensor/actuator cable Cable: 0.6 m, 8-wire, PVC Application: Untaminated zones, Zones with chemicals 	YF2A28-C60VA6XLEAX	2145385
	<ul style="list-style-type: none"> Description: Sensor/actuator cable, shielded Connection type head A: Female connector, M12, 8-pin, straight, A-coded Connection type head B: Flying leads Signal type: Sensor/actuator cable Cable: 1 m, 8-wire, PVC 	YF2A28-010VA6XLEAX	2145386

	Brief description	Type	part no.
 	<ul style="list-style-type: none"> • Application: Uncontaminated zones, Zones with chemicals • Description: Sensor/actuator cable, unshielded • Connection type head A: Female connector, M12, 8-pin, angled, A-coded • Connection type head B: Flying leads • Signal type: Sensor/actuator cable • Cable: 15 m, 8-wire, PUR, halogen-free • Application: Drag chain operation, Zones with oils and lubricants, Robot, Drag chain operation 	YG2A18-150UA5XLEAX	2149335
		CBL-CX-001000-LFPC	2077792

SICK AT A GLANCE

SICK is one of the leading manufacturers of intelligent sensors and sensor solutions for industrial applications. A unique range of products and services creates the perfect basis for controlling processes securely and efficiently, protecting individuals from accidents and preventing damage to the environment.

We have extensive experience in a wide range of industries and understand their processes and requirements. With intelligent sensors, we can deliver exactly what our customers need. In application centers in Europe, Asia and North America, system solutions are tested and optimized in accordance with customer specifications. All this makes us a reliable supplier and development partner.

Comprehensive services complete our offering: SICK LifeTime Services provide support throughout the machine life cycle and ensure safety and productivity.

For us, that is “Sensor Intelligence.”

WORLDWIDE PRESENCE:

Contacts and other locations –www.sick.com