



C40E-S143

C4000 Standard ATEX II 3G/3D

SAFETY LIGHT CURTAINS

SICK
Sensor Intelligence.



Illustration may differ

Ordering information

| Type | part no. |
|-----------|----------|
| C40E-S143 | 1070973 |

Other models and accessories → www.sick.com/C4000_Standard_ATEX_II_3G_3D

Detailed technical data

Features

| | |
|--------------------------------|--|
| Application | Explosive areas |
| Ex-approvals | ATEX for gas: II 3G Ex nA op is IIC T4 Gc X ATEX for dust: II 3D Ex tc IIIC T135°C Dc |
| System part | Receiver |
| Resolution | 14 mm |
| Scanning range | 10 m |
| Protective field height | 1,200 mm |
| Synchronization | Optical synchronization |

Safety-related parameters

| | |
|---|--|
| Type | Type 4 (IEC 61496-1) |
| Safety integrity level | SIL 3 (IEC 61508) |
| Category | Category 4 (EN ISO 13849) |
| Performance level | PL e (EN ISO 13849) |
| PFH_D (mean probability of a dangerous failure per hour) | 15×10^{-9} (EN ISO 13849) |
| T_M (mission time) | 20 years (EN ISO 13849) |
| Safe state in the event of a fault | At least one OSSD is in the OFF state. |

Functions

| | |
|---|---|
| Protective operation | ✓ |
| Restart interlock | ✓ |
| External device monitoring (EDM) | ✓ |
| Beam coding | ✓ |
| Safe SICK device communication via EFI | ✓ |

Interfaces

| | |
|---------------------------------|---|
| Configuration connection | Female connector M8, 4-pin |
| Configuration method | PC with CDS (Configuration and Diagnostic Software) |
| Display elements | 7-segment display |

Electronics

| | |
|--|---|
| Protection class | III (IEC 61140) |
| Supply voltage V_S | 24 V DC (19.2 V ... 28.8 V) ¹⁾ |
| Residual ripple | $\leq 10\%$ ²⁾ |

¹⁾ The external voltage supply must be capable of buffering brief mains voltage failures of 20 ms as specified in EN 60204-1. Suitable power supplies are available as accessories from SICK.

²⁾ Within the limits of V_S .

Mechanics

| | |
|------------------------------|---------------------------|
| Dimensions | See dimensional drawing |
| Housing cross-section | 48 mm x 40 mm |
| Housing material | Aluminum extruded profile |

Ambient data

| | |
|--------------------------------------|-------------------------------------|
| Enclosure rating | IP65 (EN 60529) |
| Ambient operating temperature | 0 °C ... +55 °C |
| Air humidity | 15 % ... 95 %, Non-condensing |
| Vibration resistance | 5 g, 10 Hz ... 55 Hz (EN 60068-2-6) |
| Shock resistance | 10 g, 16 ms (EN 60068-2-27) |

Other information

| | |
|--------------------|--------|
| Wave length | 850 nm |
|--------------------|--------|

Classifications

| | |
|-----------------------|----------|
| ECLASS 5.0 | 27272704 |
| ECLASS 5.1.4 | 27272704 |
| ECLASS 6.0 | 27272704 |
| ECLASS 6.2 | 27272704 |
| ECLASS 7.0 | 27272704 |
| ECLASS 8.0 | 27272704 |
| ECLASS 8.1 | 27272704 |
| ECLASS 9.0 | 27272704 |
| ECLASS 10.0 | 27272704 |
| ECLASS 11.0 | 27272704 |
| ECLASS 12.0 | 27272704 |
| ETIM 5.0 | EC002549 |
| ETIM 6.0 | EC002549 |
| ETIM 7.0 | EC002549 |
| ETIM 8.0 | EC002549 |
| UNSPSC 16.0901 | 46171620 |

Dimensional drawing

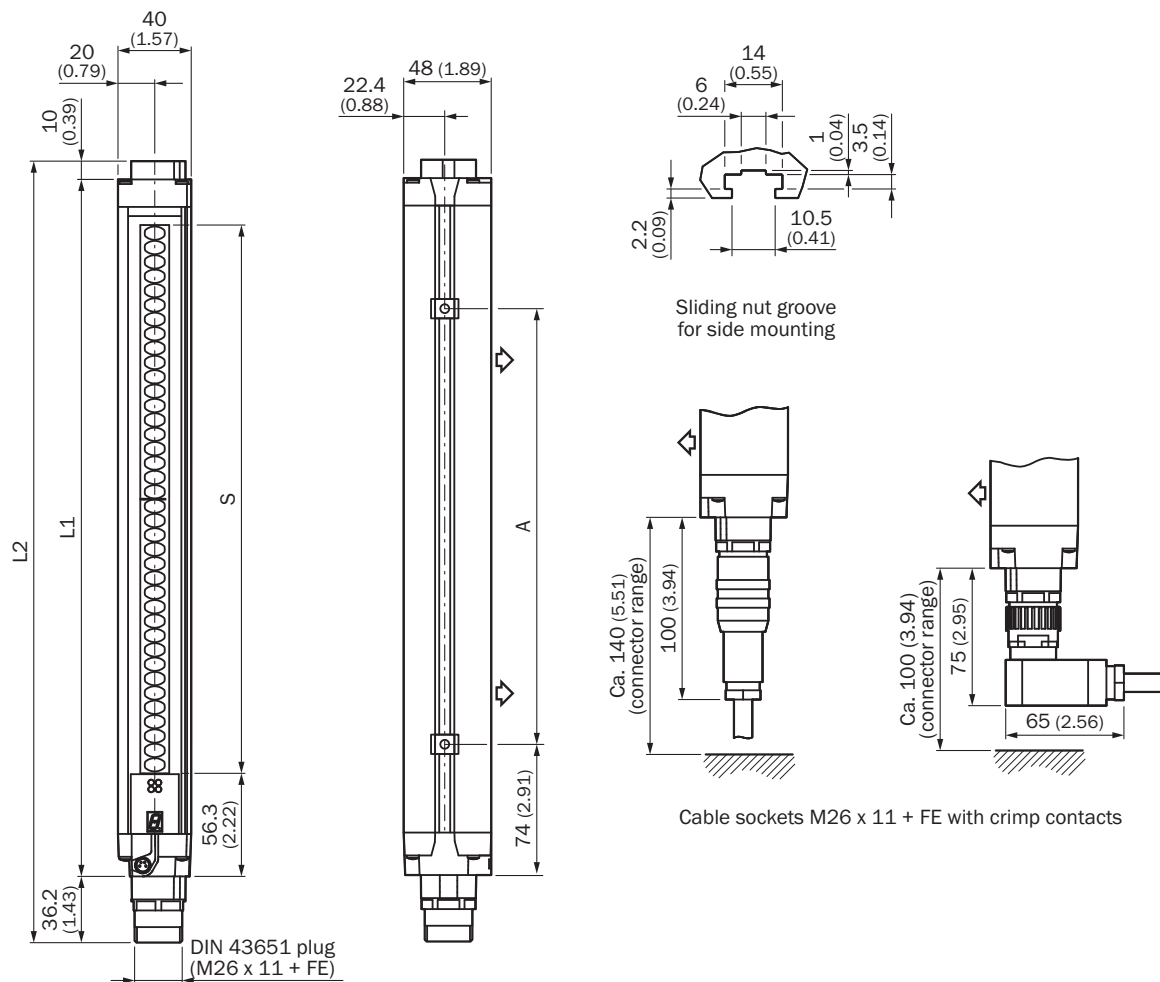



Dimensions in mm (inch)
illustration sender (receiver mirror image)





| | L1 | L2 | A |
|-------|-------|-------|-------|
| 300 | 381 | 427 | 224 |
| 450 | 532 | 578 | 374 |
| 600 | 682 | 728 | 524 |
| 750 | 833 | 879 | 674 |
| 900 | 984 | 1.030 | 824 |
| 1.050 | 1.134 | 1.180 | 974 |
| 1.200 | 1.283 | 1.329 | 1.124 |
| 1.350 | 1.435 | 1.481 | 1.274 |
| 1.500 | 1.586 | 1.632 | 1.424 |
| 1.650 | 1.736 | 1.782 | 1.574 |
| 1.800 | 1.887 | 1.933 | 1.724 |

Recommended accessories

Other models and accessories → www.sick.com/C4000_Standard_ATEX_II_3G_3D

| | Brief description | Type | part no. |
|---|---|------------|----------|
| device protection and care | | | |
|  | <ul style="list-style-type: none"> Product family: Cleaning agents Description: Cloth for cleaning optical surfaces | Lens cloth | 4003353 |
| system plugs and extension modules | | | |
|  | <ul style="list-style-type: none"> Applications: Functionality upgrade Compatible sensor types: C4000 safety light curtains | UE402 | 1023577 |

| | Brief description | Type | part no. |
|---|---|-----------------------------------|----------|
| Mounting systems | | | |
|  | <ul style="list-style-type: none"> Description: Suitable for PNS75 and PNS125 Packing unit: 6 pieces | Sliding nuts for deflector mirror | 2030600 |
|  | <ul style="list-style-type: none"> Description: Mounting kit 11, exchangeable retainer, suitable for replacement of FGS Packing unit: 4 pieces Suitable for: Large housing profile | BEF-3WNGBCST4 | 2021646 |
|  | <ul style="list-style-type: none"> Description: Stainless steel bracket, rotatable Material: Stainless steel Details: Stainless steel 1.4350, stainless steel 1.4301 Packing unit: 4 pieces | BEF-2SMMEAES4 | 2023708 |
|  | <ul style="list-style-type: none"> Description: Reinforced stainless steel bracket, rotatable Material: Stainless steel Details: Stainless steel 1.4350, stainless steel 1.4301 Packing unit: 4 pieces | BEF-2SMMVAES4 | 2026850 |
|  | <ul style="list-style-type: none"> Description: Omega bracket, rotatable, fixable with only one screw, for mounting on the swivel mount Packing unit: 4 pieces Suitable for: All protective field heights in large housing | BEF-2SMMEAAL4 | 2044847 |
|  | <ul style="list-style-type: none"> Description: Mounting kit 6, side bracket, rotatable Material: Zinc diecast Details: Zinc diecast Packing unit: 4 pieces Suitable for: All protective field heights | BEF-1SHABAZN4 | 2019506 |
|  | <ul style="list-style-type: none"> Description: Mounting kit 2, rotatable, swivel mount Material: Plastic Details: Polyamide PA6 Packing unit: 4 pieces Suitable for: All protective field heights | BEF-2SMMEAKU4 | 2019659 |
|  | <ul style="list-style-type: none"> Description: Mounting kit 1, mounting bracket, rigid, L-shaped, including fixing screws and washers Packing unit: 4 pieces Suitable for: All protective field heights | BEF-3WNGBAST4 | 7021352 |
|  | <ul style="list-style-type: none"> Description: Mounting kit 3, rotatable, with shock-absorber Packing unit: 4 pieces | BEF-1SHADAAL4 | 2017752 |
|  | <ul style="list-style-type: none"> Description: Mounting kit, rotatable, telescopic, swivel mount Material: Plastic Details: Polyamide PA6 Packing unit: 2 pieces Suitable for: All protective field heights in large housing | BEF-0SMMEA002 | 2046172 |
|  | <ul style="list-style-type: none"> Description: Sliding nut set, M5, 4x Packing unit: 4 pieces Items supplied: Included in delivery | Sliding nuts | 2017550 |
|  | <ul style="list-style-type: none"> Description: Reinforced stainless steel bracket, rotatable Material: Stainless steel Details: Stainless steel 1.4350, stainless steel 1.4301 Packing unit: 2 pieces | BEF-2SMMVAES2 | 2048373 |

| | Brief description | Type | part no. |
|---|--|------------------------------|----------|
| network devices | | | |
|  | | UE4740-22H0000 | 1046978 |
| Commissioning aids and test equipment | | | |
|  | <ul style="list-style-type: none"> • Product: Alignment aids • Dimensions (W x H x L): 19 mm 67.3 mm 66.9 mm • Description: Laser alignment aid for various sensors, laser class 2 (IEC 60825). Do not look into the beam! | AR60 | 1015741 |
|  | <ul style="list-style-type: none"> • Product: Alignment aids • Description: Adapter AR60 for housing cross-section 48 mm x 40 mm | AR60 adapter, 48x40 | 4032461 |
|  | <ul style="list-style-type: none"> • Product: Alignment aids • Description: Adapter AR60 for housing cross-section 48 mm x 40 mm in PU3H device column | AR60 adapter, 48x40, PU3H | 4056731 |

| | Brief description | Type | part no. |
|---|---|--------------------|----------|
| connectors and cables | | | |
|  | <ul style="list-style-type: none"> Description: Unshielded Connection type head A: Male connector, M26, 12-pin, straight, A-coded Connection systems: Crimp contacts Permitted cross-section: 0.5 mm² ... 1.5 mm² Note: 12 crimping contacts enclosed | STE-0612G000GA3KMC | 6021191 |
|  | <ul style="list-style-type: none"> Description: Unshielded Connection type head A: Male connector, M26, 12-pin, angled, A-coded Connection systems: Crimp contacts Permitted cross-section: 0.5 mm² ... 1.5 mm² Note: 12 crimping contacts enclosed | STE-0612W000GA3KMC | 6021192 |
|  | <ul style="list-style-type: none"> Description: Unshielded Connection type head A: Female connector, M26, 12-pin, straight, A-coded Connection systems: Crimp contacts Permitted cross-section: 0.5 mm² ... 1.5 mm² Note: 12 crimping contacts enclosed | DOS-0612G000GA3KMC | 6020757 |
|  | <ul style="list-style-type: none"> Description: Unshielded Connection type head A: Female connector, M26, 12-pin, angled, A-coded Connection systems: Crimp contacts Permitted cross-section: 0.5 mm² ... 1.5 mm² Note: 12 crimping contacts enclosed | DOS-0612W000GA3KMC | 6020758 |
|  | <ul style="list-style-type: none"> Description: Unshielded Connection type head A: Male connector, M8, 4-pin, straight Connection type head B: Male connector, USB-A, straight Cable: 2 m, 4-wire, PVC | DSL-8U04G02M025KM: | 6034574 |
|  | <ul style="list-style-type: none"> Description: Unshielded Connection type head A: Male connector, M8, 4-pin, straight Connection type head B: Male connector, USB-A, straight Cable: 10 m, 4-wire, PVC | DSL-8U04G10M025KM: | 6034575 |
|  | <ul style="list-style-type: none"> Description: Sensor/actuator cable, unshielded Connection type head A: Female connector, M26, 12-pin, straight Connection type head B: Flying leads Signal type: Sensor/actuator cable Cable: 5 m, 12-wire, PVC Connection systems: Flying leads Application: Uncontaminated zones, Zones with chemicals | DOL-0612G05M075KMC | 2022545 |
|  | <ul style="list-style-type: none"> Description: Sensor/actuator cable, unshielded Connection type head A: Female connector, M26, 12-pin, straight Connection type head B: Flying leads Signal type: Sensor/actuator cable Cable: 10 m, 12-wire, PVC Connection systems: Flying leads Application: Uncontaminated zones, Zones with chemicals | DOL-0612G10M075KMC | 2022547 |
|  | <ul style="list-style-type: none"> Description: Sensor/actuator cable, unshielded Connection type head A: Female connector, M26, 12-pin, straight Connection type head B: Flying leads Signal type: Sensor/actuator cable Cable: 15 m, 12-wire, PVC Connection systems: Flying leads Application: Uncontaminated zones, Zones with chemicals | DOL-0612G15M075KMC | 2022548 |
|  | <ul style="list-style-type: none"> Description: Sensor/actuator cable, unshielded Connection type head A: Female connector, M26, 12-pin, straight Connection type head B: Flying leads Signal type: Sensor/actuator cable Cable: 2.5 m, 12-wire, PVC Connection systems: Flying leads Application: Uncontaminated zones, Zones with chemicals | DOL-0612G2M5075KMC | 2022544 |
|  | <ul style="list-style-type: none"> Description: Sensor/actuator cable, unshielded Connection type head A: Female connector, M26, 12-pin, straight Connection type head B: Flying leads Signal type: Sensor/actuator cable Cable: 20 m, 12-wire, PVC Connection systems: Flying leads | DOL-0612G20M075KMC | 2022549 |

| | Brief description | Type | part no. |
|---|--|--------------------|----------|
|  | <ul style="list-style-type: none"> • Application: Uncontaminated zones, Zones with chemicals • Description: Sensor/actuator cable, unshielded • Connection type head A: Female connector, M26, 12-pin, straight • Connection type head B: Flying leads • Signal type: Sensor/actuator cable • Cable: 30 m, 12-wire, PVC • Connection systems: Flying leads • Application: Uncontaminated zones, Zones with chemicals | DOL-0612G30M075KM0 | 2022550 |
|  | <ul style="list-style-type: none"> • Description: Sensor/actuator cable, unshielded • Connection type head A: Female connector, M26, 12-pin, straight • Connection type head B: Flying leads • Signal type: Sensor/actuator cable • Cable: 50 m, PVC • Connection systems: Flying leads • Application: Uncontaminated zones, Zones with chemicals | DOL-0612G50M075KM0 | 2033548 |
|  | <ul style="list-style-type: none"> • Description: Sensor/actuator cable, unshielded • Connection type head A: Female connector, M26, 12-pin, straight • Connection type head B: Flying leads • Signal type: Sensor/actuator cable • Cable: 7.5 m, 12-wire, PVC • Connection systems: Flying leads • Application: Uncontaminated zones, Zones with chemicals | DOL-0612G7M5075KM0 | 2022546 |
|  | <ul style="list-style-type: none"> • Description: Unshielded • Connection type head A: Female connector, M26, 12-pin, straight • Connection type head B: Flying leads • Cable: 20 m, PVC • Connection systems: Flying leads • Note: Without EFI: Pin 9 and 10 not connected • Application: Uncontaminated zones, Zones with chemicals | DOL-0610G20M075KM0 | 2046890 |
|  | <ul style="list-style-type: none"> • Description: Unshielded • Connection type head A: Female connector, M26, 12-pin, straight • Connection type head B: Flying leads • Cable: 5 m, PVC • Connection systems: Flying leads • Note: Without EFI: Pin 9 and 10 not connected • Application: Uncontaminated zones, Zones with chemicals | DOL-0610G05M075KM0 | 2046888 |
|  | <ul style="list-style-type: none"> • Description: Unshielded • Connection type head A: Female connector, M26, 12-pin, straight • Connection type head B: Flying leads • Cable: 10 m, PVC • Connection systems: Flying leads • Note: Without EFI: Pin 9 and 10 not connected • Application: Uncontaminated zones, Zones with chemicals | DOL-0610G10M075KM0 | 2046889 |
|  | <ul style="list-style-type: none"> • Description: Unshielded • Connection type head A: Flying leads • Connection type head B: Flying leads • Items supplied: By the meter • Cable: 12-wire, PVC • Note: max. 100 m, fitting for EFI connections | Connecting cable | 6021437 |

SICK AT A GLANCE

SICK is one of the leading manufacturers of intelligent sensors and sensor solutions for industrial applications. A unique range of products and services creates the perfect basis for controlling processes securely and efficiently, protecting individuals from accidents and preventing damage to the environment.

We have extensive experience in a wide range of industries and understand their processes and requirements. With intelligent sensors, we can deliver exactly what our customers need. In application centers in Europe, Asia and North America, system solutions are tested and optimized in accordance with customer specifications. All this makes us a reliable supplier and development partner.

Comprehensive services complete our offering: SICK LifeTime Services provide support throughout the machine life cycle and ensure safety and productivity.

For us, that is “Sensor Intelligence.”

WORLDWIDE PRESENCE:

Contacts and other locations –www.sick.com