



C40S-S143

C4000 Standard ATEX II 3G/3D

SAFETY LIGHT CURTAINS

SICK
Sensor Intelligence.



Illustration may differ

Ordering information

Type	part no.
C40S-S143	1070972

Other models and accessories → www.sick.com/C4000_Standard_ATEX_II_3G_3D

Detailed technical data

Features

Application	Explosive areas
Ex-approvals	ATEX for gas: II 3G Ex nA op is IIC T4 Gc X ATEX for dust: II 3D Ex tc IIIC T135°C Dc
Resolution	14 mm
Scanning range	10 m
Protective field height	1,200 mm
Synchronization	Optical synchronization

Safety-related parameters

Type	Type 4 (IEC 61496-1)
Safety integrity level	SIL 3 (IEC 61508)
Category	Category 4 (EN ISO 13849)
Performance level	PL e (EN ISO 13849)
PFH_D (mean probability of a dangerous failure per hour)	15 x 10 ⁻⁹ (EN ISO 13849)
T_M (mission time)	20 years (EN ISO 13849)
Safe state in the event of a fault	At least one OSSD is in the OFF state.

Functions

Protective operation	✓
Restart interlock	✓
External device monitoring (EDM)	✓
Beam coding	✓
Safe SICK device communication via EFI	✓

Interfaces

Configuration connection	Female connector M8, 4-pin
Configuration method	PC with CDS (Configuration and Diagnostic Software)
Display elements	7-segment display

Electronics

Protection class	III (IEC 61140)
Supply voltage V_S	24 V DC (19.2 V ... 28.8 V) ¹⁾
Residual ripple	$\leq 10\%$ ²⁾

¹⁾ The external voltage supply must be capable of buffering brief mains voltage failures of 20 ms as specified in EN 60204-1. Suitable power supplies are available as accessories from SICK.

²⁾ Within the limits of V_S .

Mechanics

Dimensions	See dimensional drawing
Housing cross-section	48 mm x 40 mm
Housing material	Aluminum extruded profile

Ambient data

Enclosure rating	IP65 (EN 60529)
Ambient operating temperature	0 °C ... +55 °C
Air humidity	15 % ... 95 %, Non-condensing
Vibration resistance	5 g, 10 Hz ... 55 Hz (EN 60068-2-6)
Shock resistance	10 g, 16 ms (EN 60068-2-27)

Other information

Wave length	850 nm
--------------------	--------

Classifications

ECLASS 5.0	27272704
ECLASS 5.1.4	27272704
ECLASS 6.0	27272704
ECLASS 6.2	27272704
ECLASS 7.0	27272704
ECLASS 8.0	27272704
ECLASS 8.1	27272704
ECLASS 9.0	27272704
ECLASS 10.0	27272704
ECLASS 11.0	27272704
ECLASS 12.0	27272704
ETIM 5.0	EC002549
ETIM 6.0	EC002549
ETIM 7.0	EC002549
ETIM 8.0	EC002549
UNSPSC 16.0901	46171620

Dimensional drawing

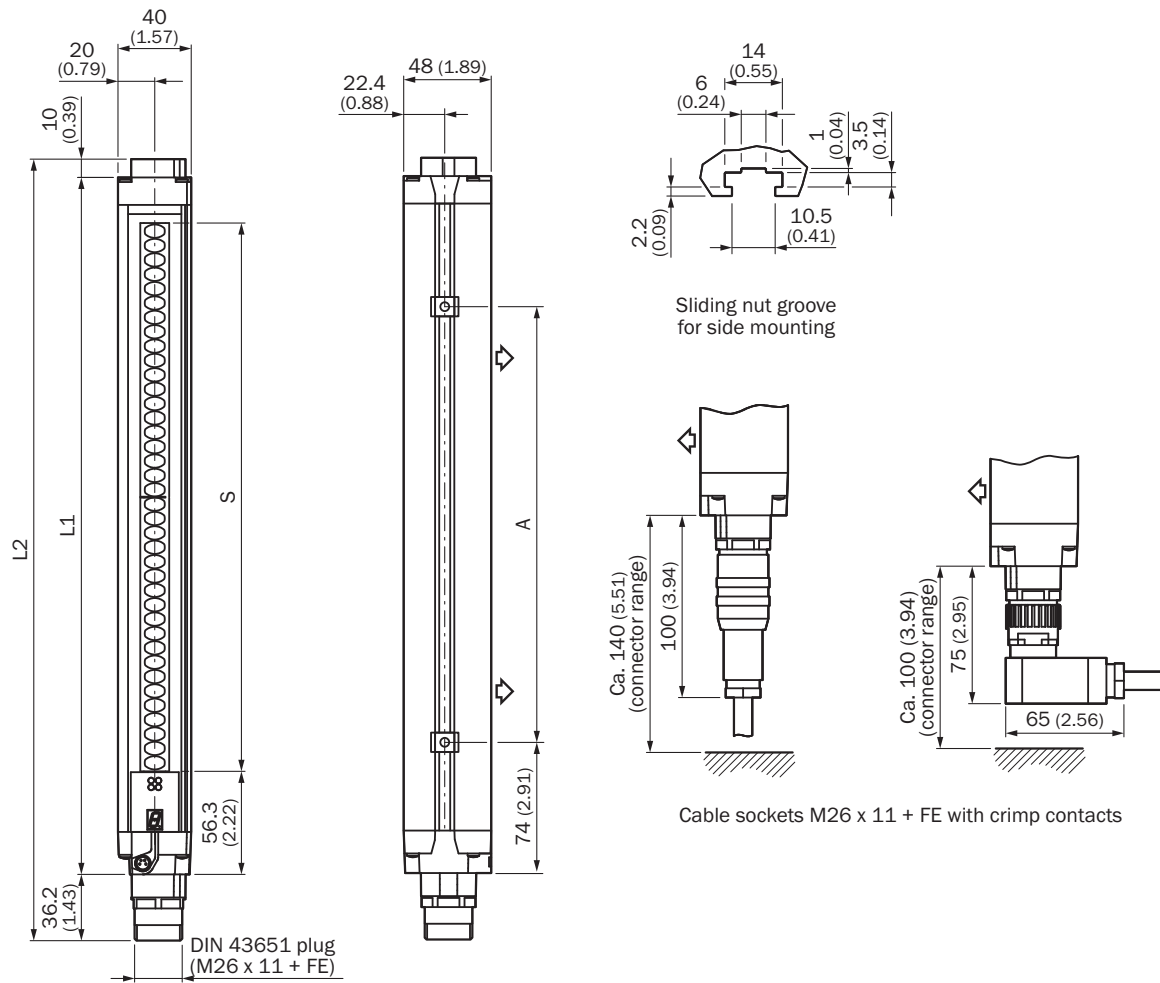



Dimensions in mm (inch)

illustration sender (receiver mirror image)





	L1	L2	A
300	381	427	224
450	532	578	374
600	682	728	524
750	833	879	674
900	984	1.030	824
1.050	1.134	1.180	974
1.200	1.283	1.329	1.124
1.350	1.435	1.481	1.274
1.500	1.586	1.632	1.424
1.650	1.736	1.782	1.574
1.800	1.887	1.933	1.724

Recommended accessories

Other models and accessories → www.sick.com/C4000_Standard_ATEX_II_3G_3D

	Brief description	Type	part no.
device protection and care			
	<ul style="list-style-type: none"> Product family: Cleaning agents Description: Cloth for cleaning optical surfaces 	Lens cloth	4003353
system plugs and extension modules			
	<ul style="list-style-type: none"> Applications: Functionality upgrade Compatible sensor types: C4000 safety light curtains 	UE402	1023577

	Brief description	Type	part no.
Mounting systems			
	<ul style="list-style-type: none"> Description: Suitable for PNS75 and PNS125 Packing unit: 6 pieces 	Sliding nuts for deflector mirror	2030600
	<ul style="list-style-type: none"> Description: Mounting kit 11, exchangeable retainer, suitable for replacement of FGS Packing unit: 4 pieces Suitable for: Large housing profile 	BEF-3WNGBCST4	2021646
	<ul style="list-style-type: none"> Description: Stainless steel bracket, rotatable Material: Stainless steel Details: Stainless steel 1.4350, stainless steel 1.4301 Packing unit: 4 pieces 	BEF-2SMMEAES4	2023708
	<ul style="list-style-type: none"> Description: Reinforced stainless steel bracket, rotatable Material: Stainless steel Details: Stainless steel 1.4350, stainless steel 1.4301 Packing unit: 4 pieces 	BEF-2SMMVAES4	2026850
	<ul style="list-style-type: none"> Description: Omega bracket, rotatable, fixable with only one screw, for mounting on the swivel mount Packing unit: 4 pieces Suitable for: All protective field heights in large housing 	BEF-2SMMEAAL4	2044847
	<ul style="list-style-type: none"> Description: Mounting kit 6, side bracket, rotatable Material: Zinc diecast Details: Zinc diecast Packing unit: 4 pieces Suitable for: All protective field heights 	BEF-1SHABAZN4	2019506
	<ul style="list-style-type: none"> Description: Mounting kit 2, rotatable, swivel mount Material: Plastic Details: Polyamide PA6 Packing unit: 4 pieces Suitable for: All protective field heights 	BEF-2SMMEAKU4	2019659
	<ul style="list-style-type: none"> Description: Mounting kit 1, mounting bracket, rigid, L-shaped, including fixing screws and washers Packing unit: 4 pieces Suitable for: All protective field heights 	BEF-3WNGBAST4	7021352
	<ul style="list-style-type: none"> Description: Mounting kit 3, rotatable, with shock-absorber Packing unit: 4 pieces 	BEF-1SHADAAL4	2017752
	<ul style="list-style-type: none"> Description: Mounting kit, rotatable, telescopic, swivel mount Material: Plastic Details: Polyamide PA6 Packing unit: 2 pieces Suitable for: All protective field heights in large housing 	BEF-0SMMEA002	2046172
	<ul style="list-style-type: none"> Description: Sliding nut set, M5, 4x Packing unit: 4 pieces Items supplied: Included in delivery 	Sliding nuts	2017550
	<ul style="list-style-type: none"> Description: Reinforced stainless steel bracket, rotatable Material: Stainless steel Details: Stainless steel 1.4350, stainless steel 1.4301 Packing unit: 2 pieces 	BEF-2SMMVAES2	2048373

	Brief description	Type	part no.
network devices			
		UE4740-22H0000	1046978
Commissioning aids and test equipment			
	<ul style="list-style-type: none"> • Product: Alignment aids • Dimensions (W x H x L): 19 mm 67.3 mm 66.9 mm • Description: Laser alignment aid for various sensors, laser class 2 (IEC 60825). Do not look into the beam! 	AR60	1015741
	<ul style="list-style-type: none"> • Product: Alignment aids • Description: Adapter AR60 for housing cross-section 48 mm x 40 mm 	AR60 adapter, 48x40	4032461
	<ul style="list-style-type: none"> • Product: Alignment aids • Description: Adapter AR60 for housing cross-section 48 mm x 40 mm in PU3H device column 	AR60 adapter, 48x40, PU3H	4056731

	Brief description	Type	part no.
connectors and cables			
	<ul style="list-style-type: none"> Description: Unshielded Connection type head A: Male connector, M26, 12-pin, straight, A-coded Connection systems: Crimp contacts Permitted cross-section: 0.5 mm² ... 1.5 mm² Note: 12 crimping contacts enclosed 	STE-0612G000GA3KMC	6021191
	<ul style="list-style-type: none"> Description: Unshielded Connection type head A: Male connector, M26, 12-pin, angled, A-coded Connection systems: Crimp contacts Permitted cross-section: 0.5 mm² ... 1.5 mm² Note: 12 crimping contacts enclosed 	STE-0612W000GA3KMC	6021192
	<ul style="list-style-type: none"> Description: Unshielded Connection type head A: Female connector, M26, 12-pin, straight, A-coded Connection systems: Crimp contacts Permitted cross-section: 0.5 mm² ... 1.5 mm² Note: 12 crimping contacts enclosed 	DOS-0612G000GA3KMC	6020757
	<ul style="list-style-type: none"> Description: Unshielded Connection type head A: Female connector, M26, 12-pin, angled, A-coded Connection systems: Crimp contacts Permitted cross-section: 0.5 mm² ... 1.5 mm² Note: 12 crimping contacts enclosed 	DOS-0612W000GA3KMC	6020758
	<ul style="list-style-type: none"> Description: Unshielded Connection type head A: Male connector, M8, 4-pin, straight Connection type head B: Male connector, USB-A, straight Cable: 2 m, 4-wire, PVC 	DSL-8U04G02M025KM	6034574
	<ul style="list-style-type: none"> Description: Unshielded Connection type head A: Male connector, M8, 4-pin, straight Connection type head B: Male connector, USB-A, straight Cable: 10 m, 4-wire, PVC 	DSL-8U04G10M025KM	6034575
	<ul style="list-style-type: none"> Description: Sensor/actuator cable, unshielded Connection type head A: Female connector, M26, 12-pin, straight Connection type head B: Flying leads Signal type: Sensor/actuator cable Cable: 5 m, 12-wire, PVC Connection systems: Flying leads Application: Uncontaminated zones, Zones with chemicals 	DOL-0612G05M075KM	2022545
	<ul style="list-style-type: none"> Description: Sensor/actuator cable, unshielded Connection type head A: Female connector, M26, 12-pin, straight Connection type head B: Flying leads Signal type: Sensor/actuator cable Cable: 10 m, 12-wire, PVC Connection systems: Flying leads Application: Uncontaminated zones, Zones with chemicals 	DOL-0612G10M075KM	2022547
	<ul style="list-style-type: none"> Description: Sensor/actuator cable, unshielded Connection type head A: Female connector, M26, 12-pin, straight Connection type head B: Flying leads Signal type: Sensor/actuator cable Cable: 15 m, 12-wire, PVC Connection systems: Flying leads Application: Uncontaminated zones, Zones with chemicals 	DOL-0612G15M075KM	2022548
	<ul style="list-style-type: none"> Description: Sensor/actuator cable, unshielded Connection type head A: Female connector, M26, 12-pin, straight Connection type head B: Flying leads Signal type: Sensor/actuator cable Cable: 2.5 m, 12-wire, PVC Connection systems: Flying leads Application: Uncontaminated zones, Zones with chemicals 	DOL-0612G2M5075KM	2022544
	<ul style="list-style-type: none"> Description: Sensor/actuator cable, unshielded Connection type head A: Female connector, M26, 12-pin, straight Connection type head B: Flying leads Signal type: Sensor/actuator cable Cable: 20 m, 12-wire, PVC Connection systems: Flying leads 	DOL-0612G20M075KM	2022549

	Brief description	Type	part no.
	<ul style="list-style-type: none"> • Application: Uncontaminated zones, Zones with chemicals • Description: Sensor/actuator cable, unshielded • Connection type head A: Female connector, M26, 12-pin, straight • Connection type head B: Flying leads • Signal type: Sensor/actuator cable • Cable: 30 m, 12-wire, PVC • Connection systems: Flying leads • Application: Uncontaminated zones, Zones with chemicals 	DOL-0612G30M075KM0	2022550
	<ul style="list-style-type: none"> • Description: Sensor/actuator cable, unshielded • Connection type head A: Female connector, M26, 12-pin, straight • Connection type head B: Flying leads • Signal type: Sensor/actuator cable • Cable: 50 m, PVC • Connection systems: Flying leads • Application: Uncontaminated zones, Zones with chemicals 	DOL-0612G50M075KM0	2033548
	<ul style="list-style-type: none"> • Description: Sensor/actuator cable, unshielded • Connection type head A: Female connector, M26, 12-pin, straight • Connection type head B: Flying leads • Signal type: Sensor/actuator cable • Cable: 7.5 m, 12-wire, PVC • Connection systems: Flying leads • Application: Uncontaminated zones, Zones with chemicals 	DOL-0612G7M5075KM0	2022546
	<ul style="list-style-type: none"> • Description: Unshielded • Connection type head A: Female connector, M26, 12-pin, straight • Connection type head B: Flying leads • Cable: 20 m, PVC • Connection systems: Flying leads • Note: Without EFI: Pin 9 and 10 not connected • Application: Uncontaminated zones, Zones with chemicals 	DOL-0610G20M075KM0	2046890
	<ul style="list-style-type: none"> • Description: Unshielded • Connection type head A: Female connector, M26, 12-pin, straight • Connection type head B: Flying leads • Cable: 5 m, PVC • Connection systems: Flying leads • Note: Without EFI: Pin 9 and 10 not connected • Application: Uncontaminated zones, Zones with chemicals 	DOL-0610G05M075KM0	2046888
	<ul style="list-style-type: none"> • Description: Unshielded • Connection type head A: Female connector, M26, 12-pin, straight • Connection type head B: Flying leads • Cable: 10 m, PVC • Connection systems: Flying leads • Note: Without EFI: Pin 9 and 10 not connected • Application: Uncontaminated zones, Zones with chemicals 	DOL-0610G10M075KM0	2046889
	<ul style="list-style-type: none"> • Description: Unshielded • Connection type head A: Flying leads • Connection type head B: Flying leads • Items supplied: By the meter • Cable: 12-wire, PVC • Note: max. 100 m, fitting for EFI connections 	Connecting cable	6021437

SICK AT A GLANCE

SICK is one of the leading manufacturers of intelligent sensors and sensor solutions for industrial applications. A unique range of products and services creates the perfect basis for controlling processes securely and efficiently, protecting individuals from accidents and preventing damage to the environment.

We have extensive experience in a wide range of industries and understand their processes and requirements. With intelligent sensors, we can deliver exactly what our customers need. In application centers in Europe, Asia and North America, system solutions are tested and optimized in accordance with customer specifications. All this makes us a reliable supplier and development partner.

Comprehensive services complete our offering: SICK LifeTime Services provide support throughout the machine life cycle and ensure safety and productivity.

For us, that is “Sensor Intelligence.”

WORLDWIDE PRESENCE:

Contacts and other locations –www.sick.com