



BTFO8-A1NM0341

HighLine

WIRE DRAW ENCODERS

SICK
Sensor Intelligence.



Ordering information

| Type | part no. |
|----------------|----------|
| BTF08-A1NM0341 | 1068886 |

Included in delivery: AHM36A-S3PC013x12 (1), MRA-F080-103D2 (1), BEF-FA-020-050WDE (1)

Other models and accessories → www.sick.com/HighLine



Detailed technical data

Safety-related parameters

| | |
|--|--|
| MTTF_D (mean time to dangerous failure) | 230 years (EN ISO 13849-1) ¹⁾ |
|--|--|

¹⁾ This product is a standard product and does not constitute a safety component as defined in the Machinery Directive. Calculation based on nominal load of components, average ambient temperature 40 °C, frequency of use 8760 h/a. All electronic failures are considered hazardous. For more information, see document no. 8015532.

Performance

| | |
|---|--------------------------|
| Measurement range | 0 m ... 3 m |
| Encoder | Absolute encoders |
| Resolution (wire draw + encoder) | 0.04 mm ^{1) 2)} |
| Repeatability | ≤ 1 mm ³⁾ |
| Linearity | ≤ ± 2 mm ³⁾ |
| Hysteresis | ≤ 2 mm ³⁾ |

¹⁾ The values shown have been rounded.

²⁾ Example calculation based on the BTF08 with PROFINET: 200 mm (wire draw length per revolution - see Mechanical data): 262,144 (number of steps per revolution) = 0.001 mm (resolution of wire draw + encoder combination).

³⁾ Value applies to wire draw mechanism.

Interfaces

| | |
|----------------------------------|-----|
| Communication interface | SSI |
| Programmable/configurable | ✓ |

Electronics

| | |
|--------------------------|---------------------------------------|
| Connection type | Male connector, M12, 8-pin, universal |
| Supply voltage | 4.5 V DC ... 32 V DC |
| Power consumption | ≤ 1.5 W (without load) |

Mechanics

| | |
|---|---|
| Weight | 1.62 kg |
| Measuring wire material | Highly flexible stranded steel 1,4401 stainless steel V4A |
| Measuring wire diameter | 1.35 mm |
| Weight (measuring wire) | 7.1 g/m |
| Housing material, wire draw mechanism | Aluminum (anodized), aluminum die cast (nickel-plated) |
| Spring return force | 6 N ... 14 N ¹⁾ |
| Length of wire pulled out per revolution | 200 mm |
| Life of wire draw mechanism | Typ. 1,000,000 cycles ^{2) 3)} |
| Actual wire draw length | 3.2 m |
| Wire acceleration | 40 m/s ² |
| Operating speed | 8 m/s |
| Mounted encoder | AHM36 SSI, AHM36A-S3PC013X12, 1068330 |
| Mounted mechanic | MRA-F080-103D2, 6030125 |

¹⁾ These values were measred at an ambient temperature of 25 °C. There may be variations at other temperatures.

²⁾ Average values, which depend on the application.

³⁾ The service life depends on the type of load. This is influenced by environmental conditions, the installation location, the measuring range in use, the traversing speed, and acceleration.

Ambient data

| | |
|------------------------------------|--|
| EMC | According to EN 61000-6-2 and EN 61000-6-3 |
| Enclosure rating | IP64, mounted mechanic IP66, Encoder (IEC 60529) IP67, Encoder (IEC 60529) |
| Operating temperature range | -30 °C ... +70 °C |

Classifications

| | |
|-----------------------|----------|
| ECLASS 5.0 | 27270590 |
| ECLASS 5.1.4 | 27270590 |
| ECLASS 6.0 | 27270590 |
| ECLASS 6.2 | 27270590 |
| ECLASS 7.0 | 27270590 |
| ECLASS 8.0 | 27270590 |
| ECLASS 8.1 | 27270590 |
| ECLASS 9.0 | 27270590 |
| ECLASS 10.0 | 27270613 |
| ECLASS 11.0 | 27270503 |
| ECLASS 12.0 | 27270503 |
| ETIM 5.0 | EC001486 |
| ETIM 6.0 | EC001486 |
| ETIM 7.0 | EC001486 |
| ETIM 8.0 | EC001486 |
| UNSPSC 16.0901 | 41112113 |

Certificates

| | |
|---|---|
| EU declaration of conformity | ✓ |
| UK declaration of conformity | ✓ |
| ACMA declaration of conformity | ✓ |
| Moroccan declaration of conformity | ✓ |
| China RoHS | ✓ |

Dimensional drawing

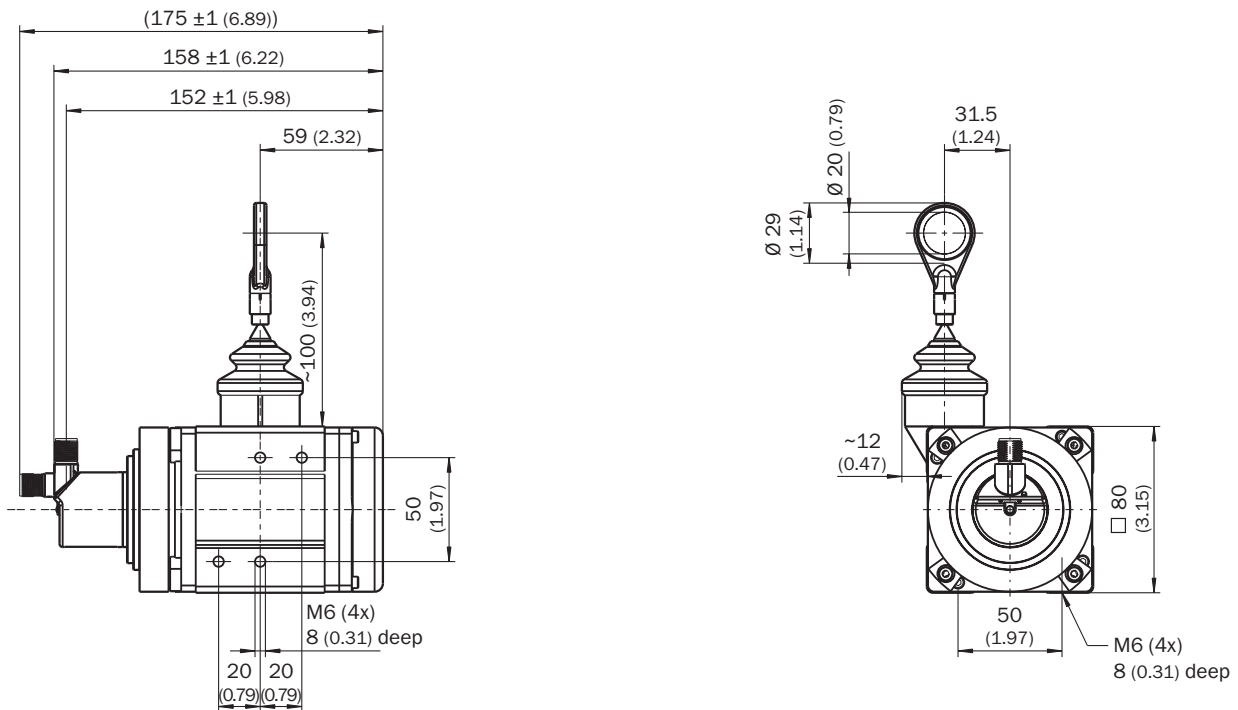

Dimensions in mm (inch)

Anschlussbelegung M12 male connector, 8-pin and cable, 8-wire, SSI/Gray

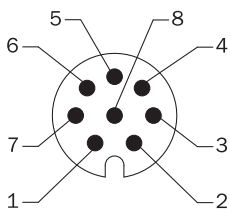





view of M12 male device connector on encoder









| PIN | Wire colors (cable connection) | Signal | Explanation |
|-----|--------------------------------|--------|-----------------------------------|
| 1 | Brown | Data - | Interface signals |
| 2 | White | Data + | Interface signals |
| 3 | Black | V/R | Sequence in direction of rotation |

| PIN | Wire colors (cable connection) | Signal | Explanation |
|-----|--------------------------------|----------------|--|
| 4 | Pink | SET | Electronic adjustment-Interface signals |
| 5 | Yellow | Clock + | Interface signals |
| 6 | Purple | Clock - | Interface signals |
| 7 | Blue | GND | Ground connection |
| 8 | Red | U _S | Operating voltage |
| - | - | Shielding | Shielding connected to housing on encoder side. Connected to ground on control side. |

Recommended accessories

Other models and accessories → www.sick.com/HighLine

| | Brief description | Type | part no. |
|---|--|--|----------|
| Mounting systems | | | |
|  | <ul style="list-style-type: none"> Description: Joint ball for later insertion in wire end ring with 20 mm diameter. The use of this joint ball enables movement in multiple levels of freedom. | Joint protection for wire rope BTF/PRF/MRA | 5318683 |
|  | <ul style="list-style-type: none"> Description: Compressed air attachment for MRA-F080... and MRA-F130... HighLine wire draw mechanism | MRA-F-P | 6073769 |
|  | <ul style="list-style-type: none"> Description: Flange adapter for HighLine wire draw mechanisms, adaption of face mount flange with centering hub 20 mm to 50 mm servo flange Material: Aluminum Details: Aluminum Items supplied: Including 3 countersunk screws M3 x 10 | BEF-FA-020-050WDE | 2073776 |
| programming devices | | | |
|  | <ul style="list-style-type: none"> Product segment: Programming devices Product: PGT-10 Pro Description: Programming unit display for programmable SICK DFS60, DFV60, AFS/AFM60, AHS/AHM36 encoders, and wire draw encoder with DFS60, AFS/AFM60 and AHS/AHM36. Compact dimensions, low weight, and intuitive operation. Items supplied: 1 x PGT-10-Pro stand-alone programming tool, 4 x alkaline type batteries, 1.5 V Mignon (AA) | PGT-10-Pro | 1072254 |
|  | <ul style="list-style-type: none"> Product segment: Programming devices Product: PGT-08-S Description: USB programming unit, for programmable SICK encoders AFS60, AFM60, DFS60, VFS60, DFV60 and wire draw encoders with programmable encoders. Not compatible with the portable SOPAS ET versions. | PGT-08-S | 1036616 |

| | Brief description | Type | part no. |
|---|--|------------------|----------|
| connectors and cables | | | |
|  | <ul style="list-style-type: none"> Description: SSI, shielded Connection type head A: Female connector, M12, 8-pin, straight Connection type head B: Male connector, D-Sub, 9-pin, straight Signal type: SSI Cable: 0.5 m, 8-wire, PUR, halogen-free Note: Suitable for use with SSI interfaces, not suitable for use with SSI + Incremental interface or SSI + Sin/Cos., programming adapter cable for programming tool PGT-10-Pro and PGT-08-S | DSL-2D08-G0M5AC2 | 2048439 |
|  | <ul style="list-style-type: none"> Description: Incremental, shielded, SSI Connection type head A: Female connector, M12, 8-pin, straight, A-coded Signal type: Incremental, SSI Cable: CAT5, CAT5e Connection systems: IDC quick connection Permitted cross-section: 0.14 mm² ... 0.34 mm² | DOS-1208-GA01 | 6045001 |
|  | <ul style="list-style-type: none"> Description: SSI, shielded, Incremental, HIPERFACE® Connection type head A: Flying leads Connection type head B: Flying leads Signal type: SSI, Incremental, HIPERFACE® Items supplied: By the meter Cable: 8-wire, PUR, halogen-free | LTG-2308-MWENC | 6027529 |
|  | <ul style="list-style-type: none"> Description: SSI, shielded, TTL, HTL, Incremental Connection type head A: Flying leads Connection type head B: Flying leads Signal type: SSI, TTL, HTL, Incremental Items supplied: By the meter Cable: 12-wire, UV and saltwater-resistant, PUR, halogen-free | LTG-2612-MW | 6028516 |
|  | <ul style="list-style-type: none"> Description: Incremental, shielded, SSI Connection type head A: Female connector, M12, 8-pin, straight Connection type head B: Flying leads Signal type: Incremental, SSI Cable: 2 m, 8-wire, PUR, halogen-free Connection systems: Flying leads Application: Drag chain operation, Zones with oils and lubricants | DOL-1208-G02MAC1 | 6032866 |
|  | <ul style="list-style-type: none"> Description: Incremental, shielded, SSI Connection type head A: Female connector, M12, 8-pin, straight Connection type head B: Flying leads Signal type: Incremental, SSI Cable: 5 m, 8-wire, PUR, halogen-free Connection systems: Flying leads Application: Drag chain operation, Zones with oils and lubricants | DOL-1208-G05MAC1 | 6032867 |
|  | <ul style="list-style-type: none"> Description: Incremental, shielded, SSI Connection type head A: Female connector, M12, 8-pin, straight Connection type head B: Flying leads Signal type: Incremental, SSI Cable: 10 m, 8-wire, PUR, halogen-free Connection systems: Flying leads Application: Drag chain operation, Zones with oils and lubricants | DOL-1208-G10MAC1 | 6032868 |
|  | <ul style="list-style-type: none"> Description: Incremental, shielded, SSI Connection type head A: Female connector, M12, 8-pin, straight Connection type head B: Flying leads Signal type: Incremental, SSI Cable: 20 m, 8-wire, PUR, halogen-free Connection systems: Flying leads Application: Drag chain operation, Zones with oils and lubricants | DOL-1208-G20MAC1 | 6032869 |
|  | <ul style="list-style-type: none"> Description: Incremental, shielded, SSI Connection type head A: Female connector, M12, 8-pin, straight Connection type head B: Flying leads Signal type: Incremental, SSI Cable: 25 m, 8-wire, PUR, halogen-free Connection systems: Flying leads Application: Drag chain operation, Zones with oils and lubricants | DOL-1208-G25MAC1 | 6067859 |

| | Brief description | Type | part no. |
|---|---|----------------|----------|
| Wire draw mechanism | | | |
|  | <ul style="list-style-type: none"> • Product segment: Wire draw mechanism • Product: Wire draw mechanism for wire draw encoders • Description: HighLine wire draw mechanism for servo flange with 6 mm shaft, measuring range 0 m ... 3 m • Items supplied: Without encoder | MRA-F080-103D2 | 6030125 |

SICK AT A GLANCE

SICK is one of the leading manufacturers of intelligent sensors and sensor solutions for industrial applications. A unique range of products and services creates the perfect basis for controlling processes securely and efficiently, protecting individuals from accidents and preventing damage to the environment.

We have extensive experience in a wide range of industries and understand their processes and requirements. With intelligent sensors, we can deliver exactly what our customers need. In application centers in Europe, Asia and North America, system solutions are tested and optimized in accordance with customer specifications. All this makes us a reliable supplier and development partner.

Comprehensive services complete our offering: SICK LifeTime Services provide support throughout the machine life cycle and ensure safety and productivity.

For us, that is “Sensor Intelligence.”

WORLDWIDE PRESENCE:

Contacts and other locations –www.sick.com