



# EXE-12C6603B020

C4000 Advanced Ex

SAFETY LIGHT CURTAINS

**SICK**  
Sensor Intelligence.

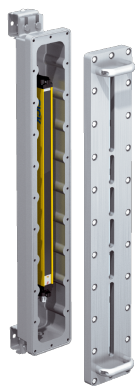

Illustration may differ



### Ordering information

Type	part no.
EXE-12C6603B020	1068403

Other models and accessories → [www.sick.com/C4000\\_Advanced\\_Ex](http://www.sick.com/C4000_Advanced_Ex)

### Detailed technical data

#### Features

<b>Application</b>	Explosive areas
<b>Ex-approvals</b>	ATEX for gas: II 2 G Ex db IIB T6 ATEX for dust: II 2 D Ex tb IIIC T56°C Db IP6X NFPA 70/NEC 500 Class I, Div. 1, Groups C and D NFPA 70/NEC 500 Class II, Div. 1, Groups E, F and G NFPA 70/NEC 500 Class III, Div. 1
<b>System part</b>	Receiver
<b>Resolution</b>	30 mm
<b>Protective field height</b>	1,200 mm
<b>Scanning range</b>	16 m
<b>Response time</b>	13 ms
<b>Synchronization</b>	Optical synchronization

#### Safety-related parameters

<b>Type</b>	Type 4 (IEC 61496-1)
<b>Safety integrity level</b>	SIL 3 (IEC 61508)
<b>Category</b>	Category 4 (EN ISO 13849)
<b>Performance level</b>	PL e (EN ISO 13849)
<b>PFH<sub>D</sub> (mean probability of a dangerous failure per hour)</b>	15 x 10 <sup>-9</sup> (EN ISO 13849)
<b>T<sub>M</sub> (mission time)</b>	20 years (EN ISO 13849)
<b>Safe state in the event of a fault</b>	At least one OSSD is in the OFF state.

#### Functions

	Functions	Delivery status
<b>Protective operation</b>	✓	
<b>Restart interlock</b>	✓	External

<b>External device monitoring (EDM)</b>	✓	Deactivated
<b>Beam coding</b>	✓	Uncoded
<b>Configurable scanning range</b>	✓	0 m ... 5 m
<b>Safe SICK device communication via EFI</b>	✓	

## Functions in combination with UE402

<b>Bypass</b>	✓
<b>Operating mode switching</b>	✓
<b>PSDI mode</b>	✓

## Interfaces

<b>System connection</b>	Connecting cable (30 m) with flying leads, 12-wire
Cable diameter	10 mm
Conductor cross section	0.75 mm <sup>2</sup>
<b>Configuration connection</b>	Female connector M8, 4-pin
<b>Configuration method</b>	PC with CDS (Configuration and Diagnostic Software)
<b>Display elements</b>	7-segment display

## Electronics

<b>Protection class</b>	III (IEC 61140)
<b>Supply voltage <math>V_S</math></b>	24 V DC (19.2 V ... 28.8 V) <sup>1)</sup>
<b>Residual ripple</b>	≤ 10 % <sup>2)</sup>
<b>Output signal switching devices (OSSDs)</b>	
Type of output	2 PNP semiconductors, short-circuit protected, cross-circuit monitored <sup>3)</sup>
ON state, switching voltage HIGH	24 V DC ( $V_S - 2.25$ V DC ... $V_S$ )
OFF state, switching voltage LOW	≤ 3.5 V DC
Current-carrying capacity per OSSD	≤ 500 mA
<b>Application diagnostic output (ADO)</b>	
Type of output	PNP semiconductor, short-circuit protected <sup>3)</sup>
Output voltage HIGH (active)	24 V DC ( $V_S - 4.2$ V DC ... $V_S$ )
Output voltage LOW (deactivated)	High resistance
Output current HIGH (active)	≤ 100 mA

<sup>1)</sup> The external voltage supply must be capable of buffering brief mains voltage failures of 20 ms as specified in EN 60204-1. Suitable power supplies are available as accessories from SICK.

<sup>2)</sup> Within the limits of  $V_S$ .

<sup>3)</sup> Applies to the voltage range between -30 V and +30 V.

## Mechanics

<b>Dimensions</b>	See dimensional drawing
<b>Housing cross-section</b>	161.8 mm x 142.1 mm
<b>Housing material</b>	Aluminum cast/AISI7Mg0.6
<b>Weight</b>	44.579 kg

## Ambient data

<b>Enclosure rating</b>	IP65 (EN 60529) IP66 (EN 60529)
-------------------------	------------------------------------

<b>Ambient operating temperature</b>	0 °C ... +55 °C
<b>Storage temperature</b>	-25 °C ... +70 °C
<b>Air humidity</b>	15 % ... 95 %, Non-condensing
<b>Vibration resistance</b>	5 g, 10 Hz ... 55 Hz (EN 60068-2-6)
<b>Shock resistance</b>	10 g, 16 ms (EN 60068-2-27)

### Other information

<b>Wave length</b>	850 nm
--------------------	--------

### Certificates

<b>EU declaration of conformity</b>	✓
<b>China RoHS</b>	✓
<b>ATEX certificate</b>	✓
<b>IECEx certificate</b>	✓
<b>cULus certificate</b>	✓
<b>China EX Type-Examination certificate</b>	✓
<b>Information according to Art. 3 of Data Act (Regulation EU 2023/2854)</b>	✓

### Classifications

<b>ECLASS 5.0</b>	27272704
<b>ECLASS 5.1.4</b>	27272704
<b>ECLASS 6.0</b>	27272704
<b>ECLASS 6.2</b>	27272704
<b>ECLASS 7.0</b>	27272704
<b>ECLASS 8.0</b>	27272704
<b>ECLASS 8.1</b>	27272704
<b>ECLASS 9.0</b>	27272704
<b>ECLASS 10.0</b>	27272704
<b>ECLASS 11.0</b>	27272704
<b>ECLASS 12.0</b>	27272704
<b>ETIM 5.0</b>	EC002549
<b>ETIM 6.0</b>	EC002549
<b>ETIM 7.0</b>	EC002549
<b>ETIM 8.0</b>	EC002549
<b>UNSPSC 16.0901</b>	46171620

Dimensional drawing C4000 Advanced Ex, 1,200 mm

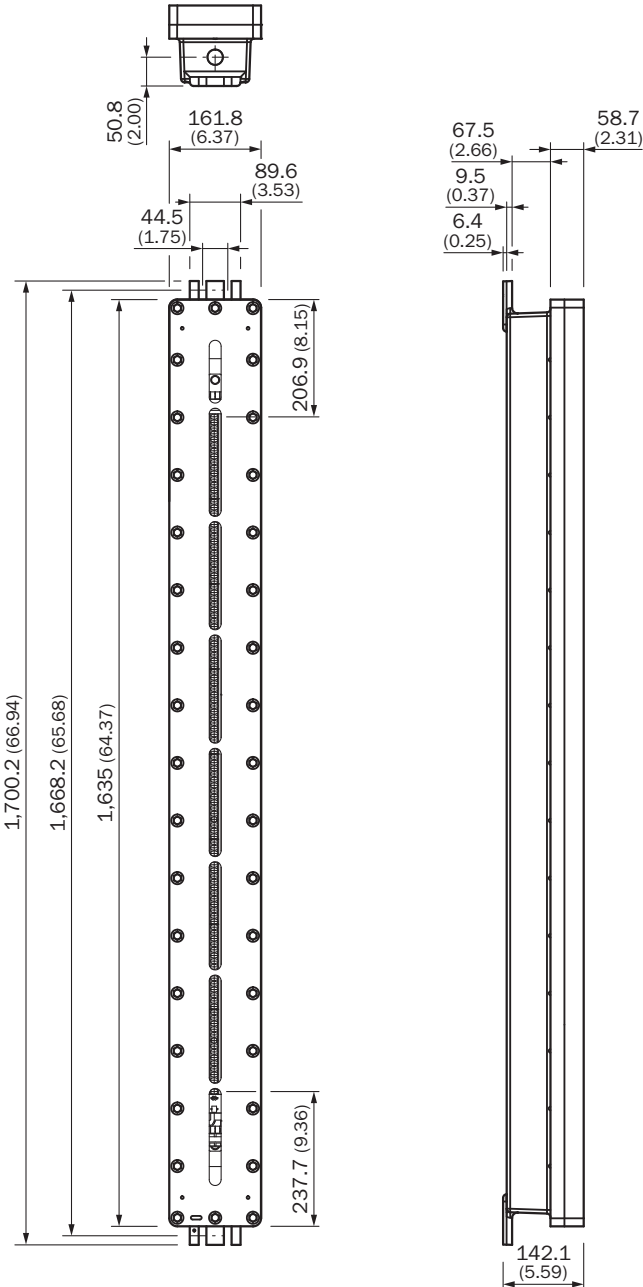

Dimensions in mm (inch)

Connection diagram C4000 Advanced safety light curtain on UE402 safety switching amplifier

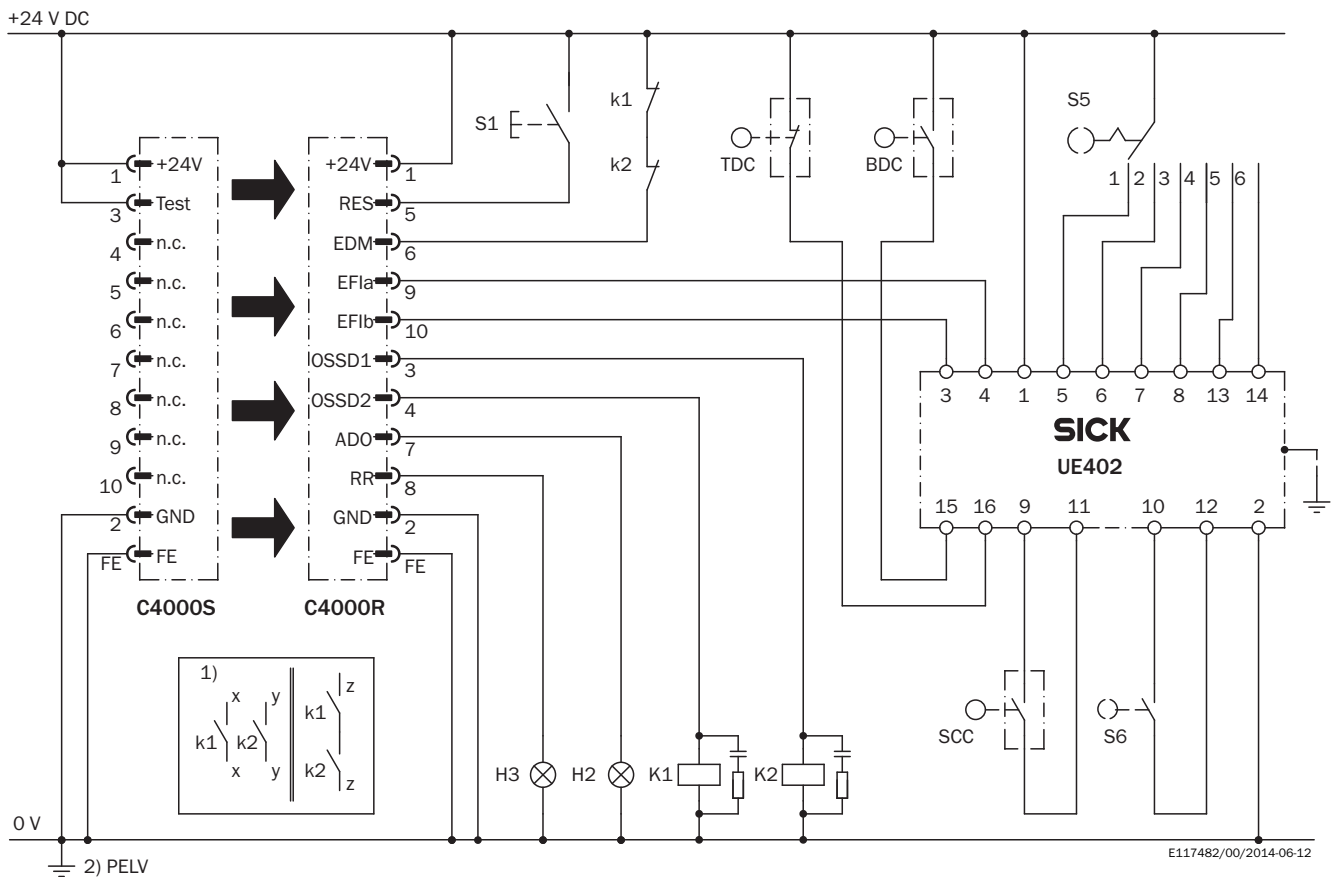

**Aufgabe**

Anbindung eines Sicherheits-Lichtvorhanges C4000 Advanced mit UE402 in eine Steuerung. 6 parametrierbare Betriebsarten mit Wiederanlaufperre und Schützkontrolle. Taktbetrieb mit TDC, BDC, SCC. Ausblendbereiche einlernbar.

**Wirkungsweise**

Wenn kein Gegenstand im aktiven Schutzfeld detektiert wird und die Schütze K1 und K2 sich in Ruhelage befinden blinkt die Lampe H3 als Aufforderung, das Befehlsgerät S1 zu betätigen. Wenn S1 betätigt (Taster wird betätigt und losgelassen) werden die OSSDs eingeschaltet. Diese schalten die Schütze K1 und K2 ein. Bei Detektion eines Gegenstandes im aktiven Schutzfeld schalten die OSSDs die Schütze K1 und K2 ab.

**Fehlerbetrachtung**







Das Fehlverhalten eines der Schütze K1 oder K2 führt nicht zum Verlust der Abschaltfunktion. Querschlüsse und Kurzschlüsse der OSSDs werden erkannt und führen zum Sperrzustand (Lock-Out). Die Manipulation (Festklemmen) des Tasters S1 verhindert die Freigabe der Ausgangskreise.

**Anmerkungen:**

Die Wirkungsweise der parametrierbaren Funktionen ist den jeweiligen Betriebsanleitungen der eingebundenen Geräte zu entnehmen. Die dabei enthaltenen Angaben sind zu beachten.

## Recommended accessories

Other models and accessories → [www.sick.com/C4000\\_Advanced\\_Ex](http://www.sick.com/C4000_Advanced_Ex)

	Brief description	Type	part no.
device protection and care			
	<ul style="list-style-type: none"> <li><b>Product family:</b> Cleaning agents</li> <li><b>Description:</b> Cloth for cleaning optical surfaces</li> </ul>	Lens cloth	4003353
Mounting systems			
	<ul style="list-style-type: none"> <li><b>Description:</b> Alignment bracket for explosion-proof enclosure</li> <li><b>Packing unit:</b> 2 pieces</li> </ul>	BEF-1SHABRST2	2072525
network devices			
		UE4740-22H0000	1046978
connectors and cables			
	<ul style="list-style-type: none"> <li><b>Note:</b> Suitable for deTec4 Core Ex, C4000 Advanced Ex and C4000 Fusion Ex safety light curtains</li> </ul>	Cable gland	5329002
Commissioning aids and test equipment			
	<ul style="list-style-type: none"> <li><b>Product:</b> Alignment aids</li> <li><b>Dimensions (W x H x L):</b> 19 mm 67.3 mm 66.9 mm</li> <li><b>Description:</b> Laser alignment aid for various sensors, laser class 2 (IEC 60825). Do not look into the beam!</li> </ul>	AR60	1015741
	<ul style="list-style-type: none"> <li><b>Product:</b> Test equipment</li> <li><b>Description:</b> 30 mm diameter, 250 mm length</li> </ul>	Test rod 30 mm	2022602

## SICK AT A GLANCE

SICK is one of the leading manufacturers of intelligent sensors and sensor solutions for industrial applications. A unique range of products and services creates the perfect basis for controlling processes securely and efficiently, protecting individuals from accidents and preventing damage to the environment.

We have extensive experience in a wide range of industries and understand their processes and requirements. With intelligent sensors, we can deliver exactly what our customers need. In application centers in Europe, Asia and North America, system solutions are tested and optimized in accordance with customer specifications. All this makes us a reliable supplier and development partner.

Comprehensive services complete our offering: SICK LifeTime Services provide support throughout the machine life cycle and ensure safety and productivity.

For us, that is “Sensor Intelligence.”

## WORLDWIDE PRESENCE:

Contacts and other locations –[www.sick.com](http://www.sick.com)