

# BCG08-I1BM0399

EcoLine

WIRE DRAW ENCODERS

**SICK**  
Sensor Intelligence.

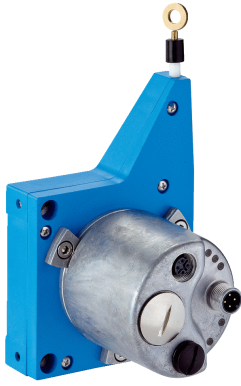

### Ordering information

Type	part no.
BCG08-I1BM0399	1061029

**Included in delivery:** AFM60A-S1IB018x12 (1), MRA-G080-103D3 (1)

Other models and accessories → [www.sick.com/EcoLine](http://www.sick.com/EcoLine)



### Detailed technical data

#### Safety-related parameters

<b>MTTF<sub>D</sub> (mean time to dangerous failure)</b>	80 years (EN ISO 13849-1) <sup>1)</sup>
--	---

<sup>1)</sup> This product is a standard product and does not constitute a safety component as defined in the Machinery Directive. Calculation based on nominal load of components, average ambient temperature 40 °C, frequency of use 8760 h/a. All electronic failures are considered hazardous. For more information, see document no. 8015532.

#### Performance

<b>Measurement range</b>	0 m ... 3 m
<b>Encoder</b>	Absolute encoders
<b>Resolution (wire draw + encoder)</b>	0.001 mm <sup>1) 2)</sup>
<b>Repeatability</b>	≤ 0.2 mm <sup>3)</sup>
<b>Linearity</b>	≤ ± 2 mm <sup>3)</sup>
<b>Hysteresis</b>	≤ 0.4 mm <sup>3)</sup>

<sup>1)</sup> The values shown have been rounded.

<sup>2)</sup> Example calculation based on the BCG08 with PROFINET: 230 mm (wire draw length per revolution - see Mechanical data): 262,144 (number of steps per revolution) = 0.001 mm (resolution of wire draw + encoder combination).

<sup>3)</sup> Value applies to wire draw mechanism.

#### Interfaces

<b>Communication interface</b>	EtherNet/IP™
<b>Programmable/configurable</b>	✓

#### Electronics

<b>Connection type</b>	Male connector, 1x, M12, 4-pin, axial Female connector, 2x, M12, 4-pin, axial
<b>Supply voltage</b>	10 V DC ... 30 V DC
<b>Power consumption</b>	≤ 3 W (without load)

## Mechanics

<b>Weight</b>	0.45 kg
<b>Measuring wire material</b>	Highly flexible stranded steel 1,4401 stainless steel V4A
<b>Measuring wire diameter</b>	0.55 mm
<b>Weight (measuring wire)</b>	1.2 g/m
<b>Housing material, wire draw mechanism</b>	Plastic, Noryl
<b>Spring return force</b>	3.3 N ... 4.4 N <sup>1)</sup>
<b>Length of wire pulled out per revolution</b>	230 mm
<b>Life of wire draw mechanism</b>	Typ. 1,000,000 cycles <sup>2) 3)</sup>
<b>Actual wire draw length</b>	3.2 m
<b>Wire acceleration</b>	10 m/s <sup>2</sup>
<b>Operating speed</b>	6 m/s
<b>Mounted encoder</b>	AFM60 EtherNet/IP, AFM60A-S1IB018x12, 1055331
<b>Mounted mechanic</b>	MRA-G080-103D3, 5322778

<sup>1)</sup> These values were measured at an ambient temperature of 25 °C. There may be variations at other temperatures.

<sup>2)</sup> Average values, which depend on the application.

<sup>3)</sup> The service life depends on the type of load. This is influenced by environmental conditions, the installation location, the measuring range in use, the traversing speed, and acceleration.

## Ambient data

<b>EMC</b>	According to EN 61000-6-2 and EN 61000-6-3 <sup>1)</sup>
<b>Enclosure rating</b>	IP50, mounted mechanic IP67, Encoder (IEC 60529) <sup>2)</sup>
<b>Operating temperature range</b>	-30 °C ... +70 °C

<sup>1)</sup> EMC according to the standards quoted is achieved if shielded cables are used.

<sup>2)</sup> For devices with male connector: with mounted mating connector.

## Classifications

<b>ECLASS 5.0</b>	27270590
<b>ECLASS 5.1.4</b>	27270590
<b>ECLASS 6.0</b>	27270590
<b>ECLASS 6.2</b>	27270590
<b>ECLASS 7.0</b>	27270590
<b>ECLASS 8.0</b>	27270590
<b>ECLASS 8.1</b>	27270590
<b>ECLASS 9.0</b>	27270590
<b>ECLASS 10.0</b>	27270613
<b>ECLASS 11.0</b>	27270503
<b>ECLASS 12.0</b>	27270503
<b>ETIM 5.0</b>	EC001486
<b>ETIM 6.0</b>	EC001486
<b>ETIM 7.0</b>	EC001486
<b>ETIM 8.0</b>	EC001486
<b>UNSPSC 16.0901</b>	41112113

Certificates

<b>EU declaration of conformity</b>	✓
<b>UK declaration of conformity</b>	✓
<b>ACMA declaration of conformity</b>	✓
<b>Moroccan declaration of conformity</b>	✓
<b>China RoHS</b>	✓

Dimensional drawing

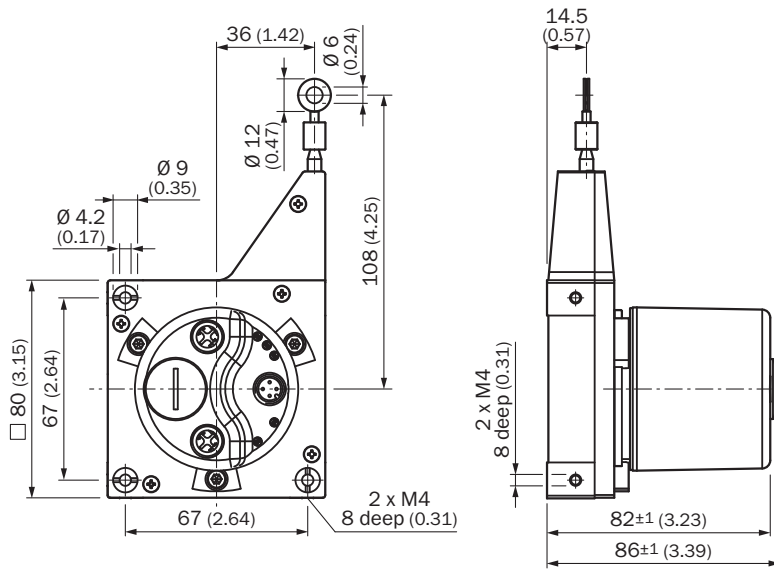

Dimensions in mm (inch)

Anschlussbelegung Female connector

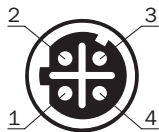

Port 1, Port 2

PIN	Signal
1	T x D+
2	R x D+
3	T x D-
4	R x D-

Anschlussbelegung Male connector

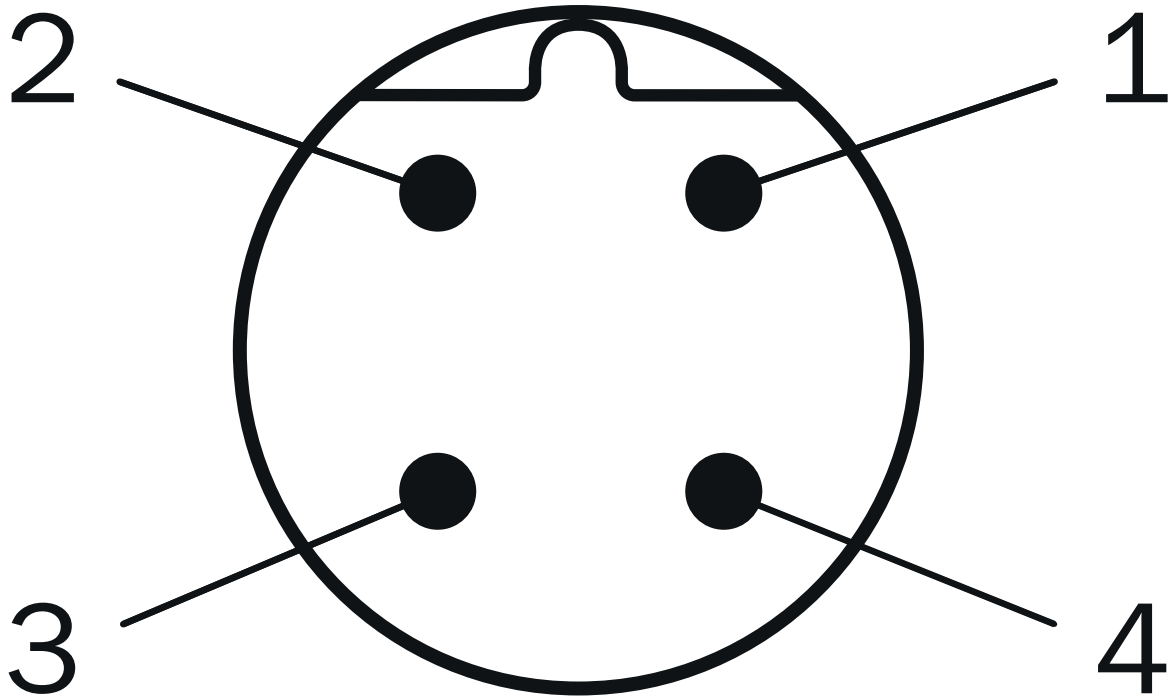

Supply voltage

PIN	Signal
1	10 V ... 30 V
2	Not assigned
3	GND
4	Not assigned

### Connection diagram

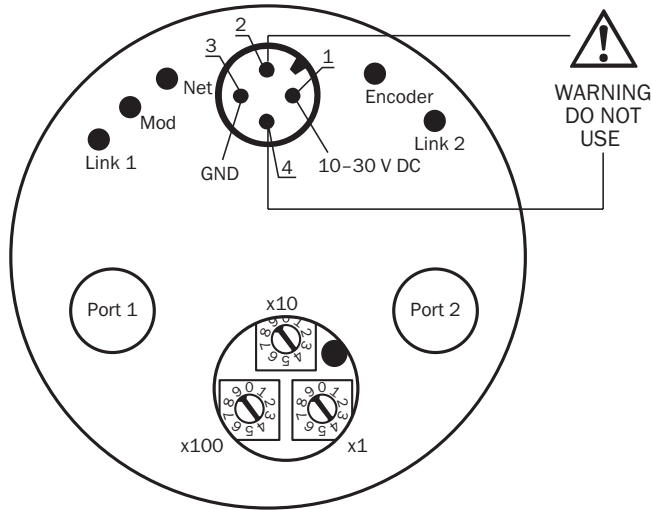







## Recommended accessories

Other models and accessories → [www.sick.com/EcoLine](http://www.sick.com/EcoLine)

	Brief description	Type	part no.
connectors and cables			
	<ul style="list-style-type: none"> <li><b>Description:</b> Unshielded</li> <li><b>Connection type head A:</b> Female connector, M12, 4-pin, angled, A-coded</li> <li><b>Connection systems:</b> Screw-type terminals</li> <li><b>Permitted cross-section:</b> ≤ 0.75 mm<sup>2</sup></li> </ul>	DOS-1204-W	6007303
	<ul style="list-style-type: none"> <li><b>Connection type head A:</b> Male connector, M12, 4-pin, straight, D-coded</li> <li><b>Connection type head B:</b> Male connector, M12, 4-pin, straight, D-coded</li> <li><b>Signal type:</b> Ethernet</li> <li><b>Cable:</b> 5 m, 4-wire, CAT5, CAT5e, PUR, halogen-free</li> <li><b>Description:</b> Ethernet, shielded</li> </ul>	SSL-1204-G05ME90	6045277
	<ul style="list-style-type: none"> <li><b>Connection type head A:</b> Male connector, M12, 4-pin, straight, D-coded</li> <li><b>Connection type head B:</b> Male connector, M12, 4-pin, straight, D-coded</li> <li><b>Signal type:</b> Ethernet</li> <li><b>Cable:</b> 10 m, 4-wire, CAT5, CAT5e, PUR, halogen-free</li> <li><b>Description:</b> Ethernet, shielded</li> </ul>	SSL-1204-G10ME90	6045279
	<ul style="list-style-type: none"> <li><b>Connection type head A:</b> Male connector, M12, 4-pin, straight, D-coded</li> <li><b>Connection type head B:</b> Flying leads</li> <li><b>Signal type:</b> Ethernet</li> <li><b>Cable:</b> 2 m, 4-wire, CAT5, CAT5e, PUR, halogen-free</li> <li><b>Description:</b> Ethernet, shielded</li> </ul>	STL-1204-G02ME90	6045284
	<ul style="list-style-type: none"> <li><b>Connection type head A:</b> Male connector, M12, 4-pin, straight, D-coded</li> <li><b>Connection type head B:</b> Flying leads</li> <li><b>Signal type:</b> Ethernet</li> <li><b>Cable:</b> 5 m, 4-wire, CAT5, CAT5e, PUR, halogen-free</li> <li><b>Description:</b> Ethernet, shielded</li> </ul>	STL-1204-G05ME90	6045285
	<ul style="list-style-type: none"> <li><b>Connection type head A:</b> Male connector, M12, 4-pin, straight, D-coded</li> <li><b>Connection type head B:</b> Flying leads</li> <li><b>Signal type:</b> Ethernet</li> <li><b>Cable:</b> 10 m, 4-wire, CAT5, CAT5e, PUR, halogen-free</li> <li><b>Description:</b> Ethernet, shielded</li> </ul>	STL-1204-G10ME90	6045286
	<ul style="list-style-type: none"> <li><b>Description:</b> Ethernet, shielded</li> <li><b>Connection type head A:</b> Female connector, M12, 4-pin, straight, D-coded</li> <li><b>Signal type:</b> Ethernet</li> <li><b>Cable:</b> CAT5, CAT5e</li> <li><b>Connection systems:</b> IDC quick connection</li> <li><b>Permitted cross-section:</b> 0.14 mm<sup>2</sup> ... 0.34 mm<sup>2</sup></li> </ul>	DOS-1204-GE	6048153
	<ul style="list-style-type: none"> <li><b>Description:</b> Ethernet, shielded</li> <li><b>Connection type head A:</b> Female connector, M12, 4-pin, angled, D-coded</li> <li><b>Signal type:</b> Ethernet</li> <li><b>Cable:</b> CAT5, CAT5e</li> <li><b>Connection systems:</b> IDC quick connection</li> <li><b>Permitted cross-section:</b> 0.14 mm<sup>2</sup> ... 0.34 mm<sup>2</sup></li> </ul>	DOS-1204-WE	6048154
	<ul style="list-style-type: none"> <li><b>Description:</b> Ethernet, shielded</li> <li><b>Connection type head A:</b> Male connector, M12, 4-pin, straight, D-coded</li> <li><b>Signal type:</b> Ethernet</li> <li><b>Cable:</b> CAT5, CAT5e</li> <li><b>Connection systems:</b> IDC quick connection</li> <li><b>Permitted cross-section:</b> 0.14 mm<sup>2</sup> ... 0.34 mm<sup>2</sup></li> </ul>	STE-1204-GE01	6048151
	<ul style="list-style-type: none"> <li><b>Description:</b> Ethernet, shielded</li> <li><b>Connection type head A:</b> Male connector, M12, 4-pin, angled, D-coded</li> <li><b>Signal type:</b> Ethernet</li> <li><b>Cable:</b> CAT5, CAT5e</li> <li><b>Connection systems:</b> IDC quick connection</li> <li><b>Permitted cross-section:</b> 0.14 mm<sup>2</sup> ... 0.34 mm<sup>2</sup></li> </ul>	STE-1204-WE	6048152
	<ul style="list-style-type: none"> <li><b>Description:</b> Gigabit Ethernet, shielded</li> <li><b>Connection type head A:</b> Male connector, RJ45, 8-pin, straight, EIA/TIA 568A/B</li> <li><b>Signal type:</b> Gigabit Ethernet</li> <li><b>Cable:</b> CAT6A</li> <li><b>Connection systems:</b> IDC quick connection</li> <li><b>Permitted cross-section:</b> 4.5 mm<sup>2</sup> ... 8 mm<sup>2</sup></li> </ul>	STE-0J08-GE	6048150
	<ul style="list-style-type: none"> <li><b>Description:</b> Ethernet, shielded</li> <li><b>Connection type head A:</b> Female connector, M12, 4-pin, D-coded</li> <li><b>Connection type head B:</b> Female connector, RJ45, 8-pin</li> <li><b>Signal type:</b> Ethernet</li> <li><b>Cable:</b> CAT5, CAT5e</li> </ul>	Feedthrough female connector Ethernet RJ45	6048180

	Brief description	Type	part no.
	<ul style="list-style-type: none"> <li><b>Note:</b> Cabinet through</li> <li><b>Description:</b> Sensor/actuator cable, unshielded</li> <li><b>Connection type head A:</b> Female connector, M12, 4-pin, straight, A-coded</li> <li><b>Connection type head B:</b> Flying leads</li> <li><b>Signal type:</b> Sensor/actuator cable</li> <li><b>Cable:</b> 2 m, 4-wire, PUR, halogen-free</li> <li><b>Application:</b> Drag chain operation, Zones with oils and lubricants, Robot, Drag chain operation</li> </ul>	YF2A14-020UB3XLEAX	2095607
	<ul style="list-style-type: none"> <li><b>Description:</b> Sensor/actuator cable, unshielded</li> <li><b>Connection type head A:</b> Female connector, M12, 4-pin, straight, A-coded</li> <li><b>Connection type head B:</b> Flying leads</li> <li><b>Signal type:</b> Sensor/actuator cable</li> <li><b>Cable:</b> 5 m, 4-wire, PUR, halogen-free</li> <li><b>Application:</b> Drag chain operation, Zones with oils and lubricants, Robot, Drag chain operation</li> </ul>	YF2A14-050UB3XLEAX	2095608
	<ul style="list-style-type: none"> <li><b>Description:</b> Sensor/actuator cable, unshielded</li> <li><b>Connection type head A:</b> Female connector, M12, 4-pin, straight, A-coded</li> <li><b>Connection type head B:</b> Flying leads</li> <li><b>Signal type:</b> Sensor/actuator cable</li> <li><b>Cable:</b> 10 m, 4-wire, PUR, halogen-free</li> <li><b>Application:</b> Drag chain operation, Zones with oils and lubricants, Robot, Drag chain operation</li> </ul>	YF2A14-100UB3XLEAX	2095609
	<ul style="list-style-type: none"> <li><b>Description:</b> Sensor/actuator cable, unshielded</li> <li><b>Connection type head A:</b> Female connector, M12, 4-pin, straight, A-coded</li> <li><b>Connection type head B:</b> Flying leads</li> <li><b>Signal type:</b> Sensor/actuator cable</li> <li><b>Cable:</b> 25 m, 4-wire, PUR, halogen-free</li> <li><b>Application:</b> Drag chain operation, Zones with oils and lubricants, Robot, Drag chain operation</li> </ul>	YF2A14-250UB3XLEAX	2095615
	<ul style="list-style-type: none"> <li><b>Description:</b> Sensor/actuator cable, unshielded</li> <li><b>Connection type head A:</b> Female connector, M12, 4-pin, angled, A-coded</li> <li><b>Connection type head B:</b> Flying leads</li> <li><b>Signal type:</b> Sensor/actuator cable</li> <li><b>Cable:</b> 2 m, 4-wire, PUR, halogen-free</li> <li><b>Application:</b> Drag chain operation, Zones with oils and lubricants, Robot, Drag chain operation</li> </ul>	YG2A14-020UB3XLEAX	2095766
	<ul style="list-style-type: none"> <li><b>Description:</b> Sensor/actuator cable, unshielded</li> <li><b>Connection type head A:</b> Female connector, M12, 4-pin, angled, A-coded</li> <li><b>Connection type head B:</b> Flying leads</li> <li><b>Signal type:</b> Sensor/actuator cable</li> <li><b>Cable:</b> 5 m, 4-wire, PUR, halogen-free</li> <li><b>Application:</b> Drag chain operation, Zones with oils and lubricants, Robot, Drag chain operation</li> </ul>	YG2A14-050UB3XLEAX	2095767
	<ul style="list-style-type: none"> <li><b>Description:</b> Sensor/actuator cable, unshielded</li> <li><b>Connection type head A:</b> Female connector, M12, 4-pin, angled, A-coded</li> <li><b>Connection type head B:</b> Flying leads</li> <li><b>Signal type:</b> Sensor/actuator cable</li> <li><b>Cable:</b> 10 m, 4-wire, PUR, halogen-free</li> <li><b>Application:</b> Drag chain operation, Zones with oils and lubricants, Robot, Drag chain operation</li> </ul>	YG2A14-100UB3XLEAX	2095768
	<ul style="list-style-type: none"> <li><b>Description:</b> Sensor/actuator cable, unshielded</li> <li><b>Connection type head A:</b> Female connector, M12, 4-pin, angled, A-coded</li> <li><b>Connection type head B:</b> Flying leads</li> <li><b>Signal type:</b> Sensor/actuator cable</li> <li><b>Cable:</b> 25 m, 4-wire, PUR, halogen-free</li> <li><b>Application:</b> Drag chain operation, Zones with oils and lubricants, Robot, Drag chain operation</li> </ul>	YG2A14-250UB3XLEAX	2095771
	<ul style="list-style-type: none"> <li><b>Connection type head A:</b> Male connector, M12, 4-pin, angled, D-coded</li> <li><b>Connection type head B:</b> Male connector, M12, 4-pin, angled, D-coded</li> <li><b>Signal type:</b> Ethernet, PROFINET</li> <li><b>Cable:</b> 2 m, 4-wire, PUR, halogen-free</li> <li><b>Description:</b> Ethernet, shielded, PROFINET</li> <li><b>Application:</b> Drag chain operation, Zones with oils and lubricants</li> </ul>	YN2D24-020P-N1N2D24	2106168
	<ul style="list-style-type: none"> <li><b>Connection type head A:</b> Male connector, M12, 4-pin, straight, D-coded</li> <li><b>Connection type head B:</b> Male connector, M12, 4-pin, straight, D-coded</li> <li><b>Signal type:</b> Ethernet, PROFINET</li> <li><b>Cable:</b> 2 m, 4-wire, PUR, halogen-free</li> <li><b>Description:</b> Ethernet, shielded, PROFINET</li> <li><b>Application:</b> Drag chain operation, Zones with oils and lubricants</li> </ul>	YM2D24-020P-N1M2D24	2106159
	<ul style="list-style-type: none"> <li><b>Connection type head A:</b> Male connector, M12, 4-pin, angled, D-coded</li> <li><b>Connection type head B:</b> Male connector, RJ45, 4-pin, straight</li> <li><b>Signal type:</b> Ethernet, PROFINET</li> <li><b>Cable:</b> 2 m, 4-wire, PUR, halogen-free</li> <li><b>Description:</b> Ethernet, shielded, PROFINET</li> </ul>	YN2D24-020P-N1MRJA4	2106162

	Brief description	Type	part no.
	<ul style="list-style-type: none"> <li><b>Application:</b> Drag chain operation, Zones with oils and lubricants</li> <li><b>Connection type head A:</b> Male connector, M12, 4-pin, straight, D-coded</li> <li><b>Connection type head B:</b> Male connector, RJ45, 4-pin, straight</li> <li><b>Signal type:</b> Ethernet, PROFINET</li> <li><b>Cable:</b> 10 m, 4-wire, PUR, halogen-free</li> <li><b>Description:</b> Ethernet, shielded, PROFINET</li> <li><b>Application:</b> Drag chain operation, Zones with oils and lubricants</li> </ul>	YM2D24-100P-N1MRJA4	2106185
	<ul style="list-style-type: none"> <li><b>Connection type head A:</b> Male connector, M12, 4-pin, straight, D-coded</li> <li><b>Connection type head B:</b> Male connector, RJ45, 4-pin, straight</li> <li><b>Signal type:</b> Ethernet, PROFINET</li> <li><b>Cable:</b> 5 m, 4-wire, PUR, halogen-free</li> <li><b>Description:</b> Ethernet, shielded, PROFINET</li> <li><b>Application:</b> Drag chain operation, Zones with oils and lubricants</li> </ul>	YM2D24-050P-N1MRJA4	2106184
	<ul style="list-style-type: none"> <li><b>Connection type head A:</b> Male connector, M12, 4-pin, straight, D-coded</li> <li><b>Connection type head B:</b> Male connector, RJ45, 8-pin, straight</li> <li><b>Signal type:</b> Ethernet</li> <li><b>Cable:</b> 5 m, 4-wire, AWG26, PUR, halogen-free</li> <li><b>Description:</b> Ethernet, twisted pair, shielded</li> </ul>	YM2D24-050EA1M-RJA4	6034415
	<ul style="list-style-type: none"> <li><b>Connection type head A:</b> Male connector, M12, 4-pin, straight, D-coded</li> <li><b>Connection type head B:</b> Male connector, RJ45, 4-pin, straight</li> <li><b>Signal type:</b> Ethernet, PROFINET</li> <li><b>Cable:</b> 2 m, 4-wire, PUR, halogen-free</li> <li><b>Description:</b> Ethernet, shielded, PROFINET</li> <li><b>Application:</b> Drag chain operation, Zones with oils and lubricants</li> </ul>	YM2D24-020P-N1MRJA4	2106182
	<ul style="list-style-type: none"> <li><b>Connection type head A:</b> Male connector, M12, 4-pin, angled, D-coded</li> <li><b>Connection type head B:</b> Male connector, RJ45, 4-pin, straight</li> <li><b>Signal type:</b> Ethernet, PROFINET</li> <li><b>Cable:</b> 10 m, 4-wire, PUR, halogen-free</li> <li><b>Description:</b> Ethernet, shielded, PROFINET</li> <li><b>Application:</b> Drag chain operation, Zones with oils and lubricants</li> </ul>	YN2D24-100P-N1MRJA4	2106164
	<ul style="list-style-type: none"> <li><b>Connection type head A:</b> Male connector, M12, 4-pin, angled, D-coded</li> <li><b>Connection type head B:</b> Male connector, RJ45, 4-pin, straight</li> <li><b>Signal type:</b> Ethernet, PROFINET</li> <li><b>Cable:</b> 5 m, 4-wire, PUR, halogen-free</li> <li><b>Description:</b> Ethernet, shielded, PROFINET</li> <li><b>Application:</b> Drag chain operation, Zones with oils and lubricants</li> </ul>	YN2D24-050P-N1MRJA4	2106163
	<ul style="list-style-type: none"> <li><b>Connection type head A:</b> Male connector, M12, 4-pin, angled, D-coded</li> <li><b>Connection type head B:</b> Flying leads</li> <li><b>Signal type:</b> Ethernet, PROFINET</li> <li><b>Cable:</b> 5 m, 4-wire, PUR, halogen-free</li> <li><b>Description:</b> Ethernet, shielded, PROFINET</li> <li><b>Application:</b> Drag chain operation, Zones with oils and lubricants</li> </ul>	YN2D24-050P-N1XLEAX	2106175
	<ul style="list-style-type: none"> <li><b>Connection type head A:</b> Male connector, M12, 4-pin, angled, D-coded</li> <li><b>Connection type head B:</b> Male connector, RJ45, 4-pin, straight</li> <li><b>Signal type:</b> Ethernet, PROFINET</li> <li><b>Cable:</b> 3 m, 4-wire, PUR, halogen-free</li> <li><b>Description:</b> Ethernet, shielded, PROFINET</li> <li><b>Application:</b> Drag chain operation, Zones with oils and lubricants</li> </ul>	YN2D24-030P-N1MRJA4	2144265
	<ul style="list-style-type: none"> <li><b>Description:</b> Sensor/actuator cable, unshielded</li> <li><b>Connection type head A:</b> Female connector, M12, 4-pin, straight, A-coded</li> <li><b>Connection type head B:</b> Flying leads</li> <li><b>Signal type:</b> Sensor/actuator cable</li> <li><b>Cable:</b> 0.6 m, 4-wire, PUR, halogen-free</li> <li><b>Application:</b> Drag chain operation, Zones with oils and lubricants, Robot, Drag chain operation</li> </ul>	YF2A14-C60UB3XLEAX	2145654
	<ul style="list-style-type: none"> <li><b>Description:</b> Sensor/actuator cable, unshielded</li> <li><b>Connection type head A:</b> Female connector, M12, 4-pin, straight, A-coded</li> <li><b>Connection type head B:</b> Flying leads</li> <li><b>Signal type:</b> Sensor/actuator cable</li> <li><b>Cable:</b> 1 m, 4-wire, PUR, halogen-free</li> <li><b>Application:</b> Drag chain operation, Zones with oils and lubricants, Robot, Drag chain operation</li> </ul>	YF2A14-010UB3XLEAX	2145655
	<ul style="list-style-type: none"> <li><b>Description:</b> Sensor/actuator cable, unshielded</li> <li><b>Connection type head A:</b> Female connector, M12, 4-pin, straight, A-coded</li> <li><b>Connection type head B:</b> Flying leads</li> <li><b>Signal type:</b> Sensor/actuator cable</li> <li><b>Cable:</b> 3 m, 4-wire, PUR, halogen-free</li> </ul>	YF2A14-030UB3XLEAX	2145656

	Brief description	Type	part no.
	<ul style="list-style-type: none"> <li><b>Application:</b> Drag chain operation, Zones with oils and lubricants, Robot, Drag chain operation</li> <li><b>Description:</b> Sensor/actuator cable, unshielded</li> <li><b>Connection type head A:</b> Female connector, M12, 4-pin, angled, A-coded</li> <li><b>Connection type head B:</b> Flying leads</li> <li><b>Signal type:</b> Sensor/actuator cable</li> <li><b>Cable:</b> 0.6 m, 4-wire, PUR, halogen-free</li> <li><b>Application:</b> Drag chain operation, Zones with oils and lubricants, Robot, Drag chain operation</li> </ul>	YG2A14-C60UB3XLEAX	2145657
	<ul style="list-style-type: none"> <li><b>Description:</b> Sensor/actuator cable, unshielded</li> <li><b>Connection type head A:</b> Female connector, M12, 4-pin, angled, A-coded</li> <li><b>Connection type head B:</b> Flying leads</li> <li><b>Signal type:</b> Sensor/actuator cable</li> <li><b>Cable:</b> 1 m, 4-wire, PUR, halogen-free</li> <li><b>Application:</b> Drag chain operation, Zones with oils and lubricants, Robot, Drag chain operation</li> </ul>	YG2A14-010UB3XLEAX	2145658
	<ul style="list-style-type: none"> <li><b>Connection type head A:</b> Male connector, M12, 4-pin, angled, D-coded</li> <li><b>Connection type head B:</b> Flying leads</li> <li><b>Signal type:</b> Ethernet, PROFINET</li> <li><b>Cable:</b> 20 m, 4-wire, PUR, halogen-free</li> <li><b>Description:</b> Ethernet, shielded, PROFINET</li> <li><b>Application:</b> Drag chain operation, Zones with oils and lubricants</li> </ul>	YN2D24-200P-N1XLEAX	2122743
	<ul style="list-style-type: none"> <li><b>Description:</b> Sensor/actuator cable, unshielded</li> <li><b>Connection type head A:</b> Female connector, M12, 4-pin, angled, A-coded</li> <li><b>Connection type head B:</b> Flying leads</li> <li><b>Signal type:</b> Sensor/actuator cable</li> <li><b>Cable:</b> 20 m, 4-wire, PUR, halogen-free</li> <li><b>Application:</b> Drag chain operation, Zones with oils and lubricants, Robot, Drag chain operation</li> </ul>	YG2A14-200UB3XLEAX	2095770
	<ul style="list-style-type: none"> <li><b>Description:</b> Sensor/actuator cable, unshielded</li> <li><b>Connection type head A:</b> Female connector, M12, 4-pin, straight, A-coded</li> <li><b>Connection type head B:</b> Flying leads</li> <li><b>Signal type:</b> Sensor/actuator cable</li> <li><b>Cable:</b> 20 m, 4-wire, PUR, halogen-free</li> <li><b>Application:</b> Drag chain operation, Zones with oils and lubricants, Robot, Drag chain operation</li> </ul>	YF2A14-200UB3XLEAX	2095611
	<ul style="list-style-type: none"> <li><b>Connection type head A:</b> Male connector, M12, 4-pin, angled, D-coded</li> <li><b>Connection type head B:</b> Flying leads</li> <li><b>Signal type:</b> Ethernet, PROFINET</li> <li><b>Cable:</b> 10 m, 4-wire, PUR, halogen-free</li> <li><b>Description:</b> Ethernet, shielded, PROFINET</li> <li><b>Application:</b> Drag chain operation, Zones with oils and lubricants</li> </ul>	YN2D24-100P-N1XLEAX	2106176
	<ul style="list-style-type: none"> <li><b>Description:</b> Sensor/actuator cable, unshielded</li> <li><b>Connection type head A:</b> Female connector, M12, 4-pin, angled, A-coded</li> <li><b>Connection type head B:</b> Flying leads</li> <li><b>Signal type:</b> Sensor/actuator cable</li> <li><b>Cable:</b> 30 m, 4-wire, PUR, halogen-free</li> <li><b>Application:</b> Drag chain operation, Zones with oils and lubricants, Robot, Drag chain operation</li> </ul>	YG2A14-300UB3XLEAX	2154444

## SICK AT A GLANCE

SICK is one of the leading manufacturers of intelligent sensors and sensor solutions for industrial applications. A unique range of products and services creates the perfect basis for controlling processes securely and efficiently, protecting individuals from accidents and preventing damage to the environment.

We have extensive experience in a wide range of industries and understand their processes and requirements. With intelligent sensors, we can deliver exactly what our customers need. In application centers in Europe, Asia and North America, system solutions are tested and optimized in accordance with customer specifications. All this makes us a reliable supplier and development partner.

Comprehensive services complete our offering: SICK LifeTime Services provide support throughout the machine life cycle and ensure safety and productivity.

For us, that is “Sensor Intelligence.”

## WORLDWIDE PRESENCE:

Contacts and other locations –[www.sick.com](http://www.sick.com)