



PFG05-E1KM0160

EcoLine

WIRE DRAW ENCODERS

SICK
Sensor Intelligence.



Ordering information

Type	part no.
PFG05-E1KM0160	1060971

Included in delivery: DBS36E-SDEK02500 (1), MRA-G055-101D4 (1)

Other models and accessories → www.sick.com/EcoLine



Detailed technical data

Safety-related parameters

MTTF_D (mean time to dangerous failure)	600 years (EN ISO 13849-1) ¹⁾
--	--

¹⁾ This product is a standard product and does not constitute a safety component as defined in the Machinery Directive. Calculation based on nominal load of components, average ambient temperature 40°C, frequency of use 8760 h/a. All electronic failures are considered hazardous. For more information, see document no. 8015532.

Performance

Measurement range	0 m ... 1.25 m
Encoder	Incremental encoders
Resolution (wire draw + encoder)	0.06 mm ^{1) 2)}
Repeatability	≤ 0.2 mm ³⁾
Linearity	≤ ± 2 mm ³⁾
Hysteresis	≤ 0.4 mm ³⁾

¹⁾ The values shown have been rounded.

²⁾ Example calculation based on the PFG08 with HTL Push Pull: 230 mm (wire draw length per revolution - see Mechanical data): 16,384 (pulses per revolution) = 0.014 mm (resolution of wire draw + encoder combination).

³⁾ Value applies to wire draw mechanism.

Interfaces

Communication interface	Incremental / HTL / Push-Pull
--------------------------------	-------------------------------

Electronics

Connection type	Cable, 8-wire, universal, 1.5 m
Supply voltage	7 V ... 30 V
Power consumption	≤ 0.5 W (without load)

Mechanics

Weight	0.23 kg
Measuring wire material	Highly flexible stranded steel 1,4401 stainless steel V4A/PA 12-sheathed
Measuring wire diameter	0.45 mm
Weight (measuring wire)	0.58 g/m
Housing material, wire draw mechanism	Plastic, Noryl
Spring return force	1 N ... 1.4 N ¹⁾
Length of wire pulled out per revolution	150 mm
Life of wire draw mechanism	Typ. 1,000,000 cycles ^{2) 3)}
Actual wire draw length	1.45 m
Wire acceleration	10 m/s ²
Operating speed	6 m/s
Mounted encoder	DBS36 Core, DBS36E-SDEK02500, 1064246
Mounted mechanic	MRA-G055-101D4, 5324019

¹⁾ These values were measured at an ambient temperature of 25 °C. There may be variations at other temperatures.

²⁾ Average values, which depend on the application.

³⁾ The service life depends on the type of load. This is influenced by environmental conditions, the installation location, the measuring range in use, the traversing speed, and acceleration.

Ambient data

EMC	According to EN 61000-6-2 and EN 61000-6-3 (class A)
Enclosure rating	IP50, mounted mechanic IP65, Encoder
Operating temperature range	-20 °C ... +70 °C

Classifications

ECLASS 5.0	27270590
ECLASS 5.1.4	27270590
ECLASS 6.0	27270590
ECLASS 6.2	27270590
ECLASS 7.0	27270590
ECLASS 8.0	27270590
ECLASS 8.1	27270590
ECLASS 9.0	27270590
ECLASS 10.0	27270613
ECLASS 11.0	27270503
ECLASS 12.0	27270503
ETIM 5.0	EC001486
ETIM 6.0	EC001486
ETIM 7.0	EC001486
ETIM 8.0	EC001486
UNSPSC 16.0901	41112113

Certificates

EU declaration of conformity	✓
-------------------------------------	---

UK declaration of conformity	✓
ACMA declaration of conformity	✓
Moroccan declaration of conformity	✓
China RoHS	✓

Dimensional drawing

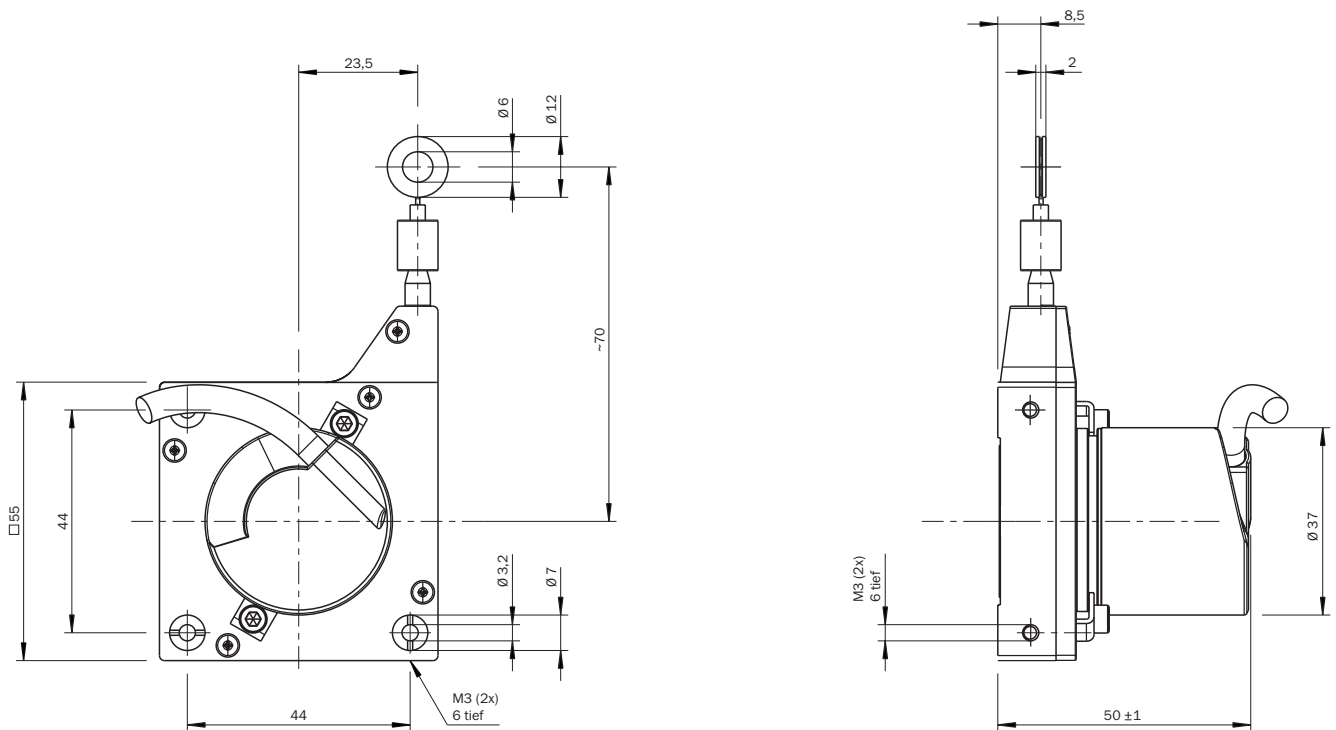

Dimensions in mm (inch)

Anschlussbelegung

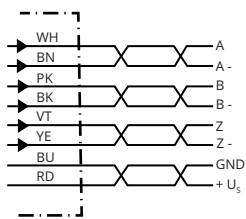









Wire colors (cable connection)	Male connector M12, 8-pin	Male connector M23, 12-pin	TTL/HTL 6-channel signal	Explanation
Brown	1	6	A-	Signal wire
White	2	5	A	Signal wire
Black	3	1	B-	Signal wire
Pink	4	8	B	Signal wire
Yellow	5	4	Z-	Signal wire
Purple	6	3	Z	Signal wire

Wire colors (cable connection)	Male connector M12, 8-pin	Male connector M23, 12-pin	TTL/HTL 6-channel signal	Explanation
Blue	7	10	GND	Ground connection
Red	8	12	+U _s	Supply voltage
-	-	9	Not assigned	Not assigned
-	-	2	Not assigned	Not assigned
-	-	11	Not assigned	Not assigned
-	-	7	Not assigned	Not assigned

Recommended accessories

Other models and accessories → www.sick.com/EcoLine

	Brief description	Type	part no.
connectors and cables			
	<ul style="list-style-type: none"> Description: SSI, shielded, Incremental, HIPERFACE® Connection type head A: Flying leads Connection type head B: Flying leads Signal type: SSI, Incremental, HIPERFACE® Items supplied: By the meter Cable: 8-wire, PUR, halogen-free 	LTG-2308-MWENC	6027529
	<ul style="list-style-type: none"> Description: SSI, shielded, Incremental Connection type head A: Flying leads Connection type head B: Flying leads Signal type: SSI, Incremental Items supplied: By the meter Cable: 11-wire, PUR 	LTG-2411-MW	6027530
	<ul style="list-style-type: none"> Description: SSI, shielded, Incremental Connection type head A: Flying leads Connection type head B: Flying leads Signal type: SSI, Incremental Items supplied: By the meter Cable: 12-wire, PUR, halogen-free 	LTG-2512-MW	6027531
	<ul style="list-style-type: none"> Description: SSI, shielded, TTL, HTL, Incremental Connection type head A: Flying leads Connection type head B: Flying leads Signal type: SSI, TTL, HTL, Incremental Items supplied: By the meter Cable: 12-wire, UV and saltwater-resistant, PUR, halogen-free 	LTG-2612-MW	6028516
	<ul style="list-style-type: none"> Description: Incremental, shielded Connection type head A: Male connector, M12, 8-pin, straight, A-coded Signal type: Incremental Cable: CAT5, CAT5e Connection systems: IDC quick connection Permitted cross-section: 0.14 mm² ... 0.34 mm² 	STE-1208-GA01	6044892
	<ul style="list-style-type: none"> Description: HIPERFACE®, shielded, SSI, Incremental Connection type head A: Male connector, M23, 12-pin, straight, A-coded Signal type: HIPERFACE®, SSI, Incremental Connection systems: Solder connection 	STE-2312-GX	6028548
	<ul style="list-style-type: none"> Description: HIPERFACE®, shielded, SSI, Incremental Connection type head A: Male connector, M23, 12-pin, straight, A-coded Signal type: HIPERFACE®, SSI, Incremental Connection systems: Solder connection 	STE-2312-G01	2077273

	Brief description	Type	part no.
programming devices			
	<ul style="list-style-type: none"> • Product segment: Programming devices • Product: PGT-10 Pro • Description: Programming unit display for programmable SICK DFS60, DFV60, AFS/AFM60, AHS/AHM36 encoders, and wire draw encoder with DFS60, AFS/AFM60 and AHS/AHM36. Compact dimensions, low weight, and intuitive operation. • Items supplied: 1 x PGT-10-Pro stand-alone programming tool, 4 x alkaline type batteries, 1.5 V Mignon (AA) 	PGT-10-Pro	1072254
	<ul style="list-style-type: none"> • Product segment: Programming devices • Product: PGT-08-S • Description: USB programming unit, for programmable SICK encoders AFS60, AFM60, DFS60, VFS60, DFV60 and wire draw encoders with programmable encoders. Not compatible with the portable SOPAS ET versions. 	PGT-08-S	1036616

SICK AT A GLANCE

SICK is one of the leading manufacturers of intelligent sensors and sensor solutions for industrial applications. A unique range of products and services creates the perfect basis for controlling processes securely and efficiently, protecting individuals from accidents and preventing damage to the environment.

We have extensive experience in a wide range of industries and understand their processes and requirements. With intelligent sensors, we can deliver exactly what our customers need. In application centers in Europe, Asia and North America, system solutions are tested and optimized in accordance with customer specifications. All this makes us a reliable supplier and development partner.

Comprehensive services complete our offering: SICK LifeTime Services provide support throughout the machine life cycle and ensure safety and productivity.

For us, that is “Sensor Intelligence.”

WORLDWIDE PRESENCE:

Contacts and other locations –www.sick.com