



DL100-21AB2103

Dx100

TIME-OF-FLIGHT SENSORS

SICK
Sensor Intelligence.



Illustration may differ



Ordering information

Type	part no.
DL100-21AB2103	1060953

Other models and accessories → www.sick.com/Dx100

Detailed technical data

Features

Measuring range	0.15 m ... 100 m, on "diamond grade" reflective tape
Scope	Indoor
Target	Reflector
Resolution	0.1 mm, 0.125 mm, 1 mm, 10 mm, 100 mm
Repeatability	0.5 mm ¹⁾
Measurement accuracy	± 2 mm ²⁾
Response time	2 ms
Measurement cycle time	1 ms
Output time	1 ms
Emitted beam	
Light source	Laser, red ³⁾
Type of light	Visible red light
Typ. light spot size (distance)	5 mm + (2 mm x distance in m)
Key laser figures	
Normative reference	IEC 60825-1:2014, EN 60825-1:2014
Laser class	2 ⁴⁾
Max. movement speed	15 m/s
Acceleration (max.)	≤ 15 m/s ²
Safety-related parameters	
MTTF _D	101 years
DC _{avg}	0%

¹⁾ Statistical error 1 σ, environmental conditions constant, min. warm-up time 10 min.

²⁾ From 150 mm ... 180 mm measuring range the accuracy can reach ± 4 mm.

³⁾ Average service life: 100,000 h at T_U = +25 °C.

⁴⁾ Do not intentionally look into the laser beam. Never point the laser beam at people's eyes.

Interfaces

Serial	✓, RS-422
Digital output	
Number	2 ¹⁾
Type	Push-pull: PNP/NPN
Function	Distance: Distance switching output
	Speed; Speed output
	Service: Warning message as the sensor ages, if the damping value is exceeded (for example when contaminated, if the permitted interior device temperature is exceeded or undercut, if the measured value has a plausibility error, if the laser is not ready for operation, if the heating is switched on
	Laser off
	Preset
Maximum output current I_A	$\leq 100 \text{ mA}$ ²⁾
Multifunctional input (MF)	1 x MF1 ³⁾

¹⁾ HIGH = $> V_S - 3 \text{ V}$ / LOW = $< 2 \text{ V}$.

²⁾ Max. 100 nF/20 mH.

³⁾ HIGH $> 12 \text{ V}$ / LOW $< 3 \text{ V}$.

Electronics

Supply voltage U_B	DC 18 V ... 30 V, limit values
Current consumption	At 24 V DC $< 250 \text{ mA}$
Ripple	5 V _{pp} ¹⁾
Modulation frequency	Adjustable
Initialization time	Typ. 1.5 s ²⁾
Display	6 digit 5 x 7 dot matrix display, LEDs
Enclosure rating	IP65
Protection class	III
Connection type	
	Male connector, M12, SPEEDCON™ compatible

¹⁾ May not fall short of or exceed V_S tolerances.

²⁾ After loss of reflector $< 40 \text{ ms}$.

Mechanics

Dimensions (W x H x D)	69.4 mm x 82.5 mm x 100.2 mm
Housing material	Metal (Aluminum die cast)
Window material	Plastic (PMMA)
Weight	Approx. 800 g (with mounting bracket: approx. 1,600 g)

Ambient data

Ambient temperature, operation	-20 °C ... +55 °C ¹⁾ -20 °C ... +75 °C, operation with cooling case ¹⁾
Ambient temperature, storage	-40 °C ... +75 °C

¹⁾ Temperatures $< -10 \text{ °C}$ require warm-up time of typ. 7 minutes.

²⁾ This is a Class A device. This device can cause radio interference in living quarters.

Effect of air pressure	0.3 ppm/hPa
Effect of air temperature	1 ppm/K
Temperature drift	Typ. 0.1 mm/K
Typ. Ambient light immunity	≤ 100,000 lx
Mechanical load	Shock: (EN 600 68-2-27) Sine: (EN 600 68-2-6) Noise: (EN 600 68-2-64)
Electromagnetic compatibility (EMC)	EN 61000-6-2, EN 61000-6-4 ²⁾

¹⁾ Temperatures < -10 °C require warm-up time of typ. 7 minutes.

²⁾ This is a Class A device. This device can cause radio interference in living quarters.

Certificates

EU declaration of conformity	✓
UK declaration of conformity	✓
ACMA declaration of conformity	✓
Moroccan declaration of conformity	✓
China RoHS	✓
cULus certificate	✓
Information according to Art. 3 of Data Act (Regulation EU 2023/2854)	✓

Classifications

ECLASS 5.0	27270801
ECLASS 5.1.4	27270801
ECLASS 6.0	27270801
ECLASS 6.2	27270801
ECLASS 7.0	27270801
ECLASS 8.0	27270801
ECLASS 8.1	27270801
ECLASS 9.0	27270801
ECLASS 10.0	27270801
ECLASS 11.0	27270801
ECLASS 12.0	27270916
ETIM 5.0	EC001825
ETIM 6.0	EC001825
ETIM 7.0	EC001825
ETIM 8.0	EC001825
UNSPSC 16.0901	41111613

Dimensional drawing

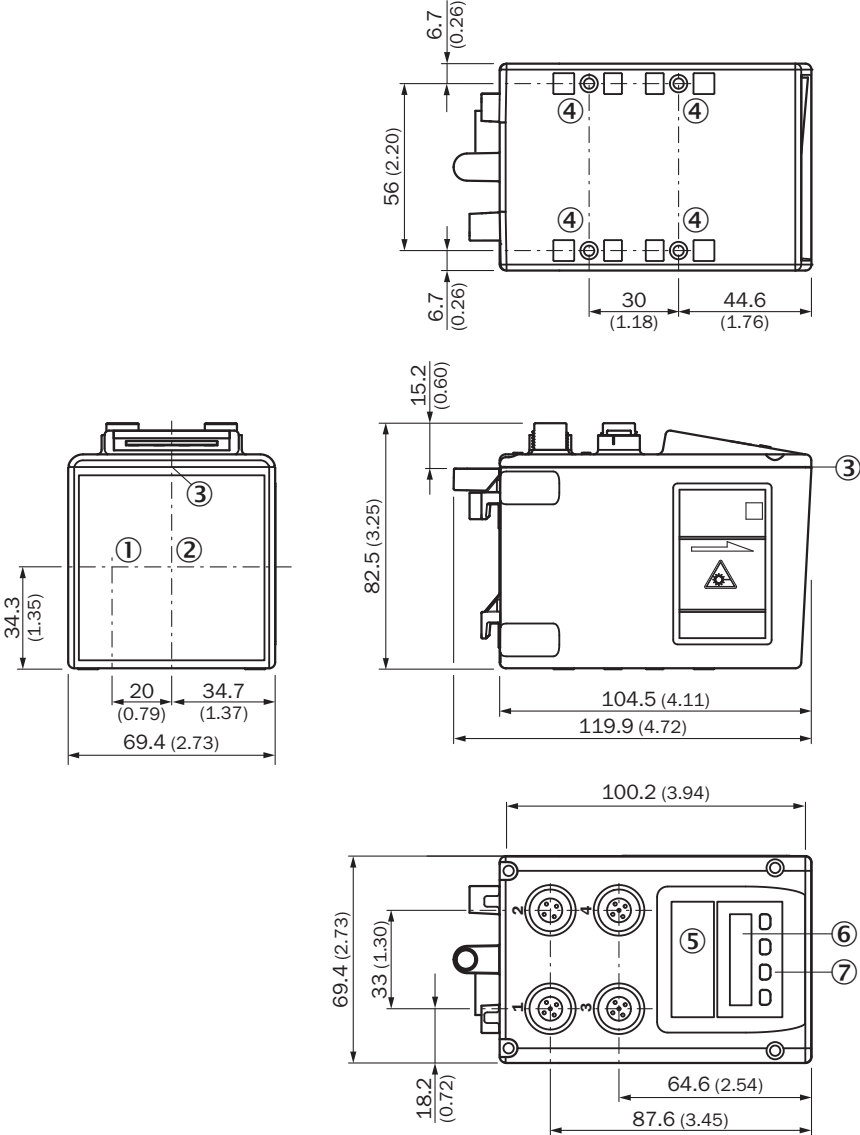

- Dimensions in mm (inch)
- ① Optical axis, sender
 - ② Optical axis, receiver
 - ③ Zero level
 - ④ Threaded mounting hole M5
 - ⑤ status LED [status]
 - ⑥ Display
 - ⑦ Control elements

SSI/RS-422 connection type

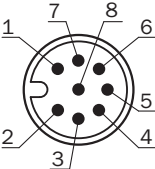

Ethernet connection type

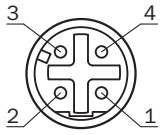

SSI/RS-422 connection diagram

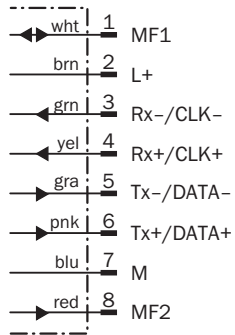

Ethernet connection diagram

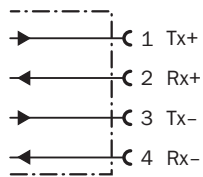

Adjustment possible DL100-xxXXxx02

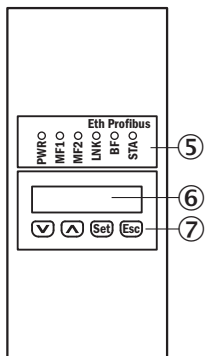









⑤ status LED [status]

⑥ Display

⑦ Control elements

Recommended accessories

Other models and accessories → www.sick.com/Dx100

	Brief description	Type	part no.
reflectors and optics			
	<ul style="list-style-type: none"> Description: Reflector plate, "diamond grade" reflective tape, 665 mm x 665 mm, base plate material: aluminum, screw connection Ambient operating temperature: -25 °C ... +65 °C 	PL560DG	1016806
	<ul style="list-style-type: none"> Description: Reflector plate, "diamond grade" reflective tape, 330 mm x 330 mm, base plate material: aluminum, screw connection Ambient operating temperature: -34 °C ... +70 °C 	PL240DG	1017910
Mounting systems			
	<ul style="list-style-type: none"> Description: Alignment unit for Dx100, incl. mounting material Material: Steel Details: Steel, zinc coated 	BEF-AH-DX100	2058653
connectors and cables			
		DME3000 Dx100 SSI/RS-422 upgrade kit	2065223
	<ul style="list-style-type: none"> Description: Shielded Connection type head A: Female connector, M12, 8-pin, straight Connection type head B: Flying leads Cable: 5 m, 8-wire, PUR, halogen-free Application: Drag chain operation, Zones with oils and lubricants 	YF2A68-050XXXXLEAX	6032449
	<ul style="list-style-type: none"> Connection type head A: Male connector, M12, 4-pin, straight, D-coded Connection type head B: Male connector, RJ45, 8-pin, straight Signal type: PROFINET Cable: 5 m, 4-wire, AWG22, PUR, halogen-free Description: PROFINET, shielded 	SSL-2J04-G05MZ	6035389
	<ul style="list-style-type: none"> Connection type head A: Female connector, M12, 8-pin, angled, A-coded Connection type head B: Male connector, M12, 8-pin, A-coded Cable: 5 m, 8-wire, PUR Application: Drag chain operation, Zones with oils and lubricants 	YG2A88-050XXXM2A88	6049328
	<ul style="list-style-type: none"> Description: Shielded, for splitting signals and power supply to DX100 & DX1000 Connection type head A: Female connector, M12, 8-pin, A-coded Connection type head B: Flying leads Connection type head C: Flying leads Cable: 2 m, PUR 	YF2A28-020XXXXLEAX Y-junctions	6048329
	<ul style="list-style-type: none"> Connection type head A: Female connector, M12, 8-pin, angled, A-coded Connection type head B: Male connector, M12, 8-pin, straight, A-coded Cable: 0.6 m, 8-wire, PUR Application: Drag chain operation, Zones with oils and lubricants 	YG2A88-C60XXXM2A88	6048801

SICK AT A GLANCE

SICK is one of the leading manufacturers of intelligent sensors and sensor solutions for industrial applications. A unique range of products and services creates the perfect basis for controlling processes securely and efficiently, protecting individuals from accidents and preventing damage to the environment.

We have extensive experience in a wide range of industries and understand their processes and requirements. With intelligent sensors, we can deliver exactly what our customers need. In application centers in Europe, Asia and North America, system solutions are tested and optimized in accordance with customer specifications. All this makes us a reliable supplier and development partner.

Comprehensive services complete our offering: SICK LifeTime Services provide support throughout the machine life cycle and ensure safety and productivity.

For us, that is “Sensor Intelligence.”

WORLDWIDE PRESENCE:

Contacts and other locations –www.sick.com