



DATA SHEET

GSE6-P1211

G6
Photoelectric sensors

PHOTOELECTRIC SENSORS

GSE6-P1211

ORDERING INFORMATION

Type	part no.
GSE6-P1211	1060792

Further device versions and accessories at www.sick.com/G6



Illustration may differ



DETAILED TECHNICAL DATA

FEATURES

Functional principle	Through-beam photoelectric sensor	
Sensing range max.	0 m ... 15 m	
Sensing range	0 m ... 10 m	
Polarisation filter	No	
Emitted beam	Light source	PinPoint LED ¹⁾
	Type of light	Visible red light
	Light spot size (distance)	Ø 375 mm (12 m)
Key LED figures	Wave length	650 nm
	Adjustment	Potentiometer, 270°
Part number of individual components	2058063 GS6-D1311 2066449 GE6-P1211	

¹⁾ Average service life: 100,000 h at T_u = +25 °C.

SAFETY-RELATED PARAMETERS

MTTF _D	971 years
DC _{avg}	0%
T _M (mission time)	20 years

ELECTRONICS

Supply voltage U_B	10 V DC ... 30 V DC ¹⁾
Ripple	$\pm 10\%$ ²⁾
Current consumption	30 mA ³⁾
Protection class	III
Digital output	<p>Type PNP</p> <p>Switching mode Light/dark switching</p> <p>Switching mode selector Selectable via light/dark selector</p> <p>Signal voltage PNP HIGH/LOW $V_S - (\leq 3\text{ V}) / \text{approx. } 0\text{ V}$</p> <p>Output current I_{max} $\leq 100\text{ mA}$ ⁴⁾</p> <p>Response time $< 500\ \mu\text{s}$ ⁵⁾</p> <p>Switching frequency 1,000 Hz ⁶⁾</p>
Circuit protection	A ⁷⁾ B ⁸⁾ D ⁹⁾

¹⁾ Limit values when operated in short-circuit protected network: max. 8 A.

²⁾ May not fall below or exceed U_V tolerances.

³⁾ Without load.

⁴⁾ At $U_V > 24\text{ V}$, $I_A \text{ max.} = 50\text{ mA}$.

⁵⁾ Signal transit time with resistive load.

⁶⁾ With light/dark ratio 1:1.

⁷⁾ A = V_S connections reverse-polarity protected.

⁸⁾ B = inputs and output reverse-polarity protected.

⁹⁾ D = outputs overcurrent and short-circuit protected.

MECHANICS

Housing	Rectangular
Dimensions (W x H x D)	12 mm x 31.5 mm x 21 mm
Connection	Cable, 3-wire, 2 m ¹⁾
Connection detail	<p>Conductor size 0.14 mm²</p> <p>Length of cable (L) 2 m ¹⁾</p>
Material	<p>Housing Plastic, ABS/PC</p> <p>Front screen Plastic, PMMA</p> <p>Cable Plastic, PVC</p>
Weight	170 g

¹⁾ Do not bend below 0 °C.

AMBIENT DATA

Enclosure rating	IP67
Ambient operating temperature	-25 °C ... +55 °C ¹⁾
Ambient temperature, storage	-40 °C ... +70 °C
UL File No.	NRKH.E348498 & NRKH7.E348498

¹⁾ Temperature stability following adjustment +/-10 °C.

CERTIFICATES

EU declaration of conformity	✓
UK declaration of conformity	✓
ACMA declaration of conformity	✓
Moroccan declaration of conformity	✓
China RoHS	✓
cULus certificate	✓
Photobiological safety (DIN EN 62471) certificate	✓

DIMENSIONAL DRAWING

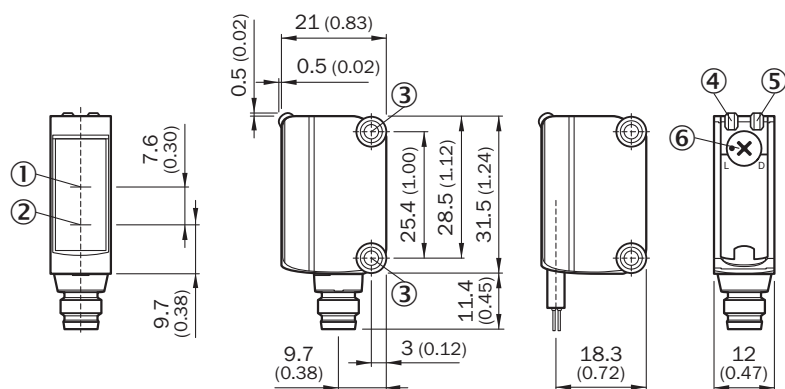

Dimensions in mm (inch)

- ① Optical axis, receiver
- ② Optical axis, sender
- ③ Mounting holes M3
- ④ LED indicator green: Supply voltage active
- ⑤ LED indicator yellow: Status of received light beam
- ⑥ Light/ dark rotary switch: L = light switching, D = dark switching

ADJUSTMENTS ADJUSTMENT POSSIBILITY

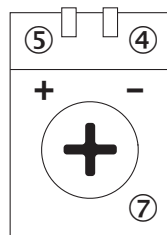

- ④ LED indicator green: Supply voltage active
- ⑤ LED indicator yellow: Status of received light beam
- ⑦ Sensitivity control: potentiometer

CONNECTION TYPE

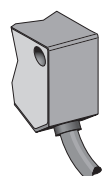

CONNECTION DIAGRAM CD-049

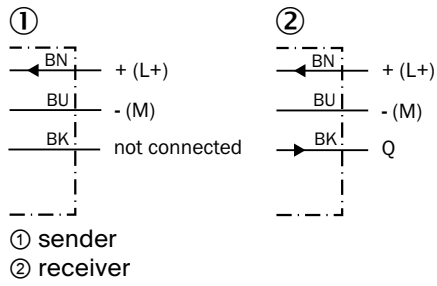

CHARACTERISTIC CURVE WITH GE6-P1111, GE6-N1111, GE6-P1111S63

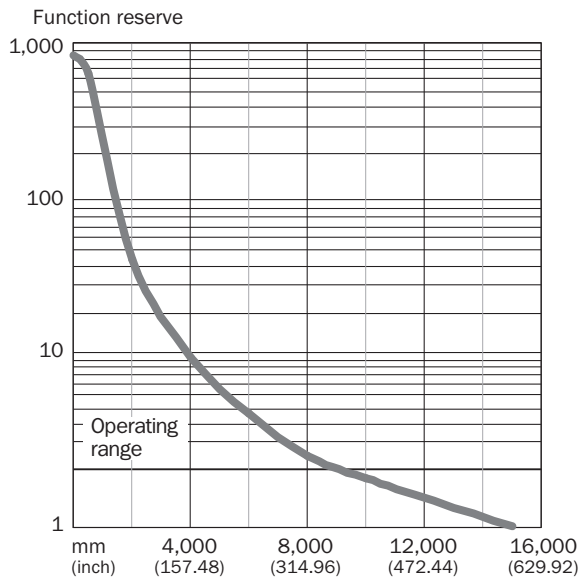

LIGHT SPOT SIZE

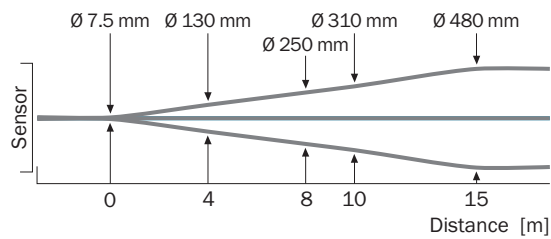

SENSING RANGE DIAGRAM

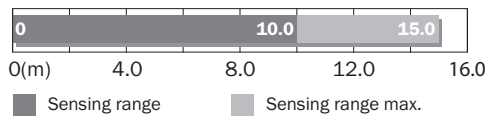

Further information as well as suitable accessories, example applications and downloads such as CAD dimensional models, operating instructions and software can be found at www.sick.com/1060792



SICK AG
WALDKIRCH
GERMANY
SICK.COM

SICK AT A GLANCE

SICK is a leading global technology company for intelligent sensors and integrated solutions in industrial automation. Our technologies set benchmarks, making your industrial processes more efficient, safer and more sustainable – both in logistics and manufacturing operations.

SICK combines sensor intelligence with industry expertise and certified consulting services. We provide the ideal foundation for scalable as well as tailor-made automation solutions and create added value along the entire value chain. Our close partnerships with our customers are more than just a promise: Together, we optimize productivity, improve quality, protect health and safety, and help build a sustainable future. All with empathy and trust.

Since 1946, we have been developing innovative technologies with passion and a pioneering spirit. With a global network in around 40 countries, SICK has a global presence and is always close by. The company's headquarters are located in Waldkirch near Freiburg, Germany. Our customers benefit from our understanding of both local and global requirements, which enables us to deliver tailor-made solutions

SICK
Sensor Intelligence