



ICR620D-T11503 DPM Plus

Lector62x

IMAGE-BASED CODE READERS

SICK
Sensor Intelligence.



Illustration may differ



Ordering information

Type	part no.
ICR620D-T11503 DPM Plus	1055891

Other models and accessories → www.sick.com/Lector62x

Detailed technical data

Features

Variant	Complete device
Optical focus	Teach auto focus
Sensor	CMOS monochrome
Sensor resolution	752 px x 480 px (WVGA)
Illumination	Integrated
Illumination color	Red, LED, Visible, 617 nm, ± 15 nm Blue, LED, Visible, 470 nm, ± 15 nm
LED class	1 (IEC 62471:2006-07, EN 62471:2008-09)
Feedback spot	LED, Visible, green, 525 nm, ± 15 nm
Alignment aid	Laser, Red, 630 nm ... 680 nm
Laser class	1, complies with 21 CFR 1040.10 except for the conformance according to "Laser Notice No. 50" from June 24, 2007 (IEC 60825-1:2014, EN 60825-1:2014+A11:2021)
Lens	
Focal length	7 mm
Scanning frequency	60 Hz, WVGA resolution
Code resolution	≥ 0.1 mm ¹⁾
Working range	30 mm ... 500 mm ²⁾

¹⁾ Valid for Data Matrix, PDF417, and 1D codes with good print quality.

²⁾ For details see reading field diagram.

Mechanics/electronics

Connection type	1 x M12, 17-pin male connector 1 x M12, 4-pin Ethernet female connector
Supply voltage	10 V DC ... 30 V DC
Power consumption	Typ. 3 W
Output current	≤ 100 mA
Housing material	Aluminum die cast
Housing color	Light blue (RAL 5012)
Window material	Glass
Enclosure rating	IP65 (EN 60529 (1991-10), EN 60529/A2 (2002-02))
Protection class	III
Electrical safety	EN 60950-1 (2006-04) / EN 60950-1/A11 (2009-03)
Weight	170 g
Dimensions (L x W x H)	71 mm x 43 mm x 35.6 mm ¹⁾
MTBF	75,000 h

¹⁾ Swivel connector is 17.8 mm longer.

Performance

Readable code structures	1D codes, Stacked, 2D codes, direct-marked codes
Bar code types	GS1-128 / EAN 128, UPC / GTIN / EAN, Interleaved 2 of 5, Pharmacode, GS1 DataBar, Code 39, Code 128, Codabar, Code 32, Code 93
2D code types	Data Matrix ECC200, GS1 Data-Matrix, PDF417, QR code, PDF417 Truncated
Code qualification	On the basis of ISO/IEC 16022, ISO/IEC 15415, ISO/IEC 18004, ISO TR 29158/AIM DPM
No. of codes per reading interval	1 ... 50
No. of characters per reading interval	500 (for multiplexer function in CAN operation)
Internal image storage	135 MB
Transport speed	4 m/s

Interfaces

Ethernet	✓ , TCP/IP
Function	Data interface (read result output), Service interface, OPC DA Server, FTP (image transmission)
Data transmission rate	10/100 MBit/s
PROFINET	✓
Function	PROFINET Single Port, PROFINET Dual Port (optional via external connection module CDF600-2)
Data transmission rate	10/100 MBit/s
EtherNet/IP™	✓
Data transmission rate	10/100 MBit/s
EtherCAT®	✓
Type of fieldbus integration	Optional over external fieldbus module CDF600
Serial	✓ , RS-232, RS-422
Function	Data interface (read result output), Service interface
Data transmission rate	0.3 kBaud ... 115.2 kBaud, AUX: 57.6 kBaud (RS-232)
CAN	✓

Function	SICK CAN sensor network CSN (CAN controller/CAN device, multiplexer/server)
Data transmission rate	20 kbit/s ... 1 Mbit/s
CANopen	✓
Data transmission rate	20 kbit/s ... 1 Mbit/s
PROFIBUS DP	✓
Type of fieldbus integration	Optional over external fieldbus module CDF600-2
Digital inputs	4 ("Sensor 1", "Sensor 2", 2 inputs via optional parameter storage CMC600 in CDB620/CDM420)
Digital outputs	4 ("Result 1", "Result 2", 2 outputs via CMC and CDB620/CDM420 or "Result 1", "Result 2", "Result 3", "Result 4" when using the 17-wire cable with open cable end)
Reading pulse	Digital inputs, non-powered, serial interface, Ethernet, CAN, auto pulse, presentation mode
Optical indicators	16 LEDs (5 x status display, 10 x LED bar graph, 1 green feedback spot)
Acoustic indicators	Beeper/buzzer (can be switched off, can be assigned a function to signal a result)
Control elements	2 buttons (choose and start/stop functions)
Operator interfaces	Web server
Configuration software	SOPAS ET
Memory card	Micro SD memory card (flash card) max. 32 GB, optional
Data storage and retrieval	Image and data storage via microSD memory card and external FTP
EncoderFrequency	Max. 300 Hz
External illumination control	Via digital output (max. 24 V trigger)

Ambient data

Electromagnetic compatibility (EMC)	EN 61000-6-2 (2006-03) / EN 61000-6-2 (2009-05)
Vibration resistance	EN 60068-2-6:2008-02
Shock resistance	EN 60068-2-27:2009-05
Ambient operating temperature	0 °C ... +50 °C
Storage temperature	-20 °C ... +70 °C
Permissible relative humidity	90 %, Non-condensing
Ambient light immunity	2,000 lx, on code

Certificates

EU declaration of conformity	✓
UK declaration of conformity	✓
ACMA declaration of conformity	✓
China RoHS	✓
cULus certificate	✓
Profinet certificate	✓
BIS registration	✓

Classifications

ECLASS 5.0	27280103
ECLASS 5.1.4	27280103
ECLASS 6.0	27280103
ECLASS 6.2	27280103
ECLASS 7.0	27280103

ECLASS 8.0	27280103
ECLASS 8.1	27280103
ECLASS 9.0	27280103
ECLASS 10.0	27280103
ECLASS 11.0	27280103
ECLASS 12.0	27280103
ETIM 5.0	EC002550
ETIM 6.0	EC002550
ETIM 7.0	EC002999
ETIM 8.0	EC002999
UNSPSC 16.0901	43211701

Dimensional drawing

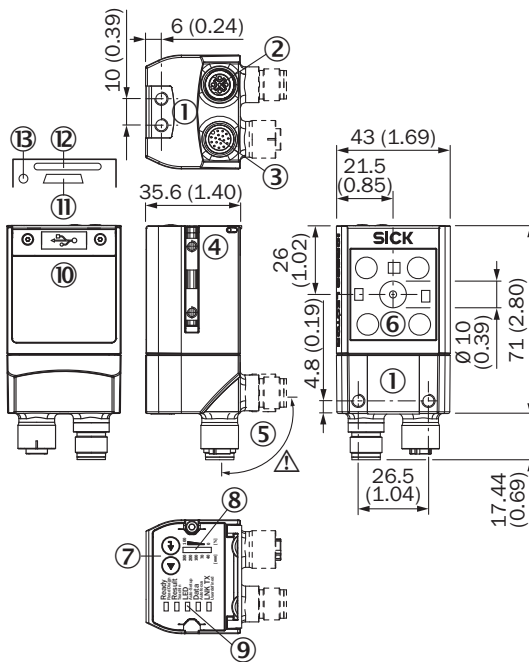

Dimensions in mm (inch)

- ① M5 blind tapped holes, 5 mm deep (4 x), for mounting the sensor
- ② “Ethernet” connection, 4-pin M12 female connector, D-coded
- ③ “Power/Serial Data/CAN/I/O” connection, 17-pin M12 male connector, A-coded
- ④ Sliding nut M5, 5 mm deep (2 x), for mounting (as alternative)
- ⑤ swivel connector unit
- ⑥ Reading field
- ⑦ Function button (2 x)
- ⑧ Bar graph display
- ⑨ LEDs for status display (2 levels), 5 x
- ⑩ Cover (flap)
- ⑪ “Micro USB” connection
- ⑫ Slot for microSD memory card
- ⑬ LED for microSD memory card

Reading field diagram

Working distance in mm (inch)

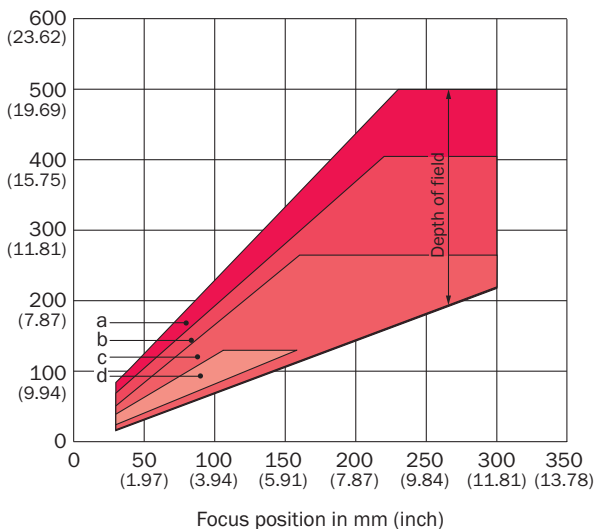

Resolution

 a: 1.00 mm (39.4 mil)	 c: 0.50 mm (19.7 mil)
 b: 0.75 mm (29.5 mil)	 d: 0.25 mm (9.8 mil)

Working distance in mm (inch)

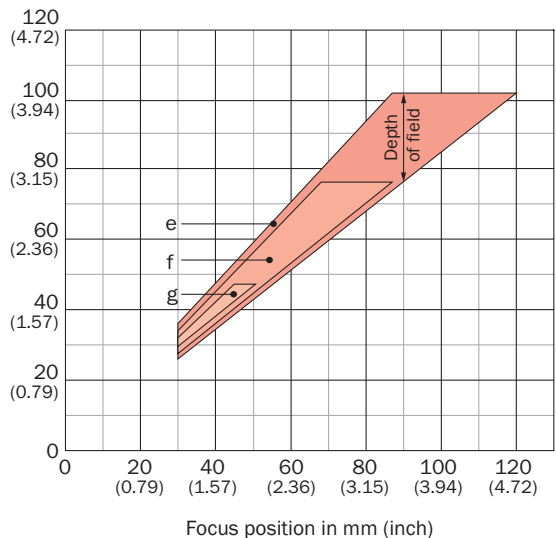

Resolution

 e: 0.20 mm (7.9 mil)	 g: 0.10 mm (3.9 mil)
 f: 0.15 mm (5.9 mil)	

Field of view

Field of view: H x V (mm) ①

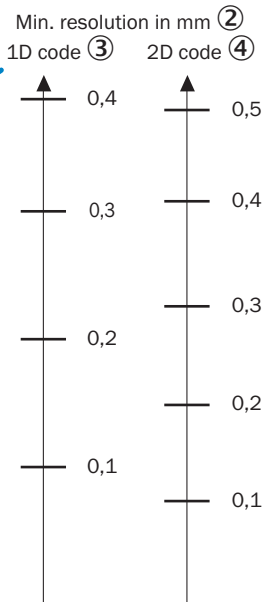
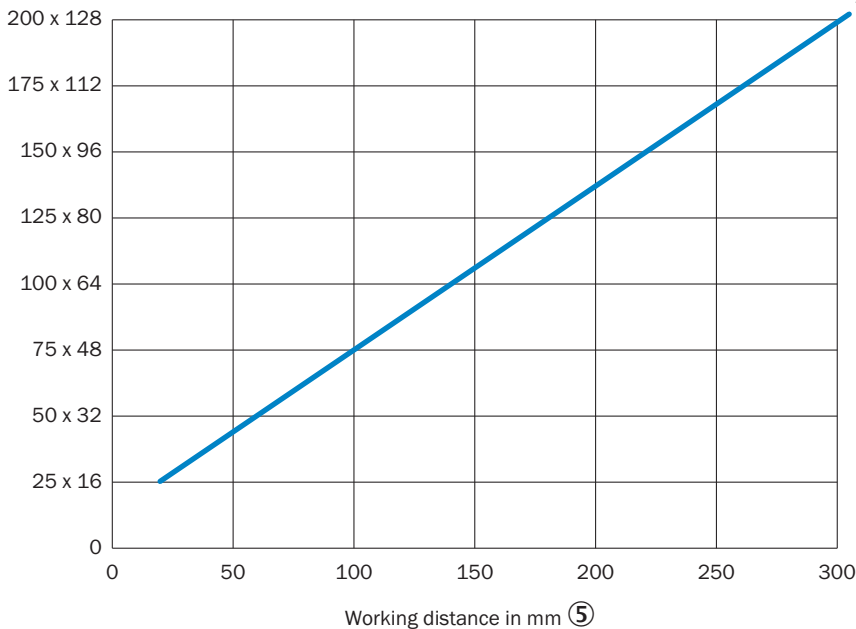







— f = 7 mm (ICR620H-T11503, ICR620D-T11503, ICR620D-T17503, ICR620C-T11503S50)

- ① Field of view: Horizontal x vertical in mm
- ② Minimum resolution in mm
- ③ 1D code

- ④ 2D code
- ⑤ Working distance in mm (inch)

Recommended accessories

Other models and accessories → www.sick.com/Lector62x

	Brief description	Type	part no.
Mounting systems			
	<ul style="list-style-type: none"> Description: Bracket with adapter board 	Mounting bracket	2042902
network devices			
		CDF600-2100	1058965
		CDF600-2103	1058966
connectors and cables			
	<ul style="list-style-type: none"> Description: USB 2.0, unshielded Connection type head A: Male connector, Micro-B, 4-pin, straight Connection type head B: Male connector, USB-A, 4-pin, straight Signal type: USB 2.0 Cable: 2 m, 4-wire 	YMUSA4-020VG4MUIA4	6036106
	<ul style="list-style-type: none"> Connection type head A: Male connector, M12, 4-pin, straight, D-coded Connection type head B: Male connector, RJ45, 4-pin, straight Signal type: Ethernet, PROFINET Cable: 2 m, 4-wire, PUR, halogen-free Description: Ethernet, shielded, PROFINET Application: Drag chain operation, Zones with oils and lubricants 	YM2D24-020P-N1MRJA4	2106182
Junction boxes			
		CDB620-001	1042256

SICK AT A GLANCE

SICK is one of the leading manufacturers of intelligent sensors and sensor solutions for industrial applications. A unique range of products and services creates the perfect basis for controlling processes securely and efficiently, protecting individuals from accidents and preventing damage to the environment.

We have extensive experience in a wide range of industries and understand their processes and requirements. With intelligent sensors, we can deliver exactly what our customers need. In application centers in Europe, Asia and North America, system solutions are tested and optimized in accordance with customer specifications. All this makes us a reliable supplier and development partner.

Comprehensive services complete our offering: SICK LifeTime Services provide support throughout the machine life cycle and ensure safety and productivity.

For us, that is “Sensor Intelligence.”

WORLDWIDE PRESENCE:

Contacts and other locations –www.sick.com