

SICK.COM



DATA SHEET

**WL4S-3N2430V**

W4  
Photoelectric sensors

**SICK** Sensor Intelligence

## PHOTOELECTRIC SENSORS

## WL4S-3N2430V

## ORDERING INFORMATION

Type	part no.
WL4S-3N2430V	1054712

Further device versions and accessories at [www.sick.com/W4](http://www.sick.com/W4)



Illustration may differ

## DETAILED TECHNICAL DATA

## FEATURES

Functional principle	Photoelectric retro-reflective sensor	
Functional principle detail	Without reflector minimum distance (autocollimation/coaxial optics)	
Sensing range max.	0 m ... 4 m <sup>1)</sup>	
Sensing range	0 m ... 2.5 m <sup>1)</sup>	
Polarisation filter	Yes	
Emitted beam	Light source	PinPoint LED <sup>2)</sup>
	Type of light	Visible red light
	Light spot size (distance)	Ø 45 mm (1.5 m)
Key LED figures	Wave length	650 nm
	Adjustment	None
Special applications	Hygienic and washdown zones	
Housing design	Washdown	

<sup>1)</sup> Reflector PL80A.

<sup>2)</sup> Average service life: 100,000 h at T<sub>u</sub> = +25 °C.

## SAFETY-RELATED PARAMETERS

MTTF <sub>D</sub>	1,530 years
DC <sub>avg</sub>	0 %
T <sub>M</sub> (mission time)	20 years

**ELECTRONICS**

Supply voltage $U_B$	10 V DC ... 30 V DC <sup>1)</sup>
Ripple	< 5 V <sub>pp</sub> <sup>2)</sup>
Current consumption	30 mA <sup>3)</sup>
Protection class	III
Digital output	Type NPN Switching mode Light/dark switching Output current $I_{max}$ ≤ 100 mA Response time < 0.5 ms <sup>4)</sup> Switching frequency 1,000 Hz <sup>5)</sup>
Output function	Complementary
Circuit protection	A <sup>6)</sup> B <sup>7)</sup> C <sup>8)</sup>

<sup>1)</sup> Limit values, reverse-polarity protected, operation in short-circuit protected network: max. 8 A.

<sup>2)</sup> May not fall below or exceed  $U_V$  tolerances.

<sup>3)</sup> Without load.

<sup>4)</sup> Signal transit time with resistive load.

<sup>5)</sup> With light/dark ratio 1:1.

<sup>6)</sup> A =  $V_B$  connections reverse-polarity protected.

<sup>7)</sup> B = inputs and output reverse-polarity protected.

<sup>8)</sup> C = interference suppression.

**MECHANICS**

Housing	Rectangular
Design detail	Slim
Dimensions (W x H x D)	15.25 mm x 48.6 mm x 22.2 mm
Connection	Male connector M12, 4-pin <sup>1)</sup>
Material	Housing Metal, Stainless steel V4A (1.4404, 316L) Front screen Plastic, PMMA
Weight	60 g

<sup>1)</sup> Max. tightening torque: 0.7 Nm.

**AMBIENT DATA**

Enclosure rating	IP66 IP67 IP68 IP69K
Ambient operating temperature	-30 °C ... +70 °C <sup>1)</sup> -30 °C ... +60 °C
Ambient temperature, storage	-30 °C ... +75 °C
UL File No.	NRKH.E181493 & NRKH7.E181493

<sup>1)</sup> At  $UV \leq 24$  V and  $IA < 30$  mA.

**CERTIFICATES**

EU declaration of conformity	✓
------------------------------	---

# PHOTOELECTRIC SENSORS - WL4S-3N2430V

UK declaration of conformity	✓
ACMA declaration of conformity	✓
Moroccan declaration of conformity	✓
China RoHS	✓
ECOLAB certificate	✓
Photobiological safety (DIN EN 62471) certificate	✓

## CONNECTION DIAGRAM CD-083

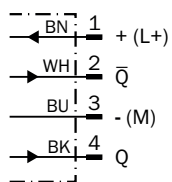

## CHARACTERISTIC CURVE WL4S-3, WLG4S-3, 4 M

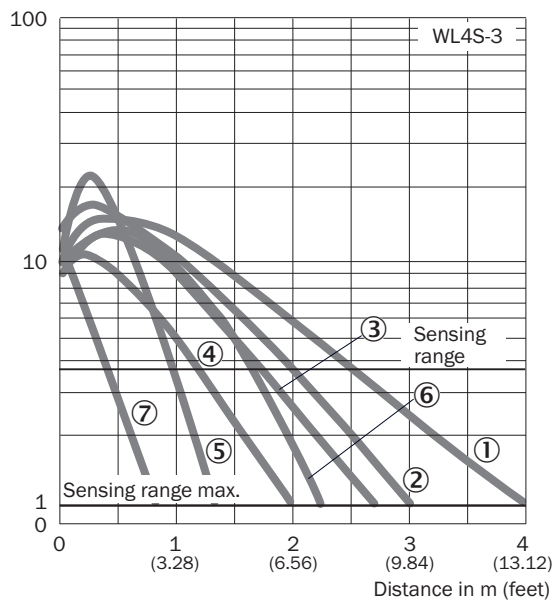

- ① Reflector PL80A
- ② Reflector P250F
- ③ Reflector PL40A
- ④ Reflector PL20A
- ⑤ PL10F reflector
- ⑥ Reflector P250 CHEM
- ⑦ Reflective tape REF-IRF-56

**SENSING RANGE DIAGRAM WL4S-3, WLG4S-3, 4 M**

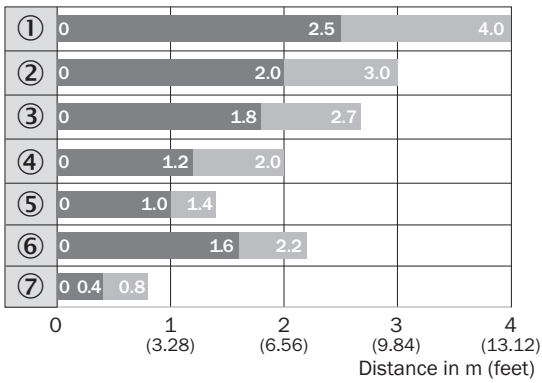

■ Sensing range      ■ Sensing range max.

- ① Reflector PL80A
- ② Reflector P250F
- ③ Reflector PL40A
- ④ Reflector PL20A
- ⑤ PL10F reflector
- ⑥ Reflector P250 CHEM
- ⑦ Reflective tape REF-IRF-56

**DIMENSIONAL DRAWING WL4S-3V, WLG4S-3V, WITHOUT SINGLE TEACH-IN BUTTON**

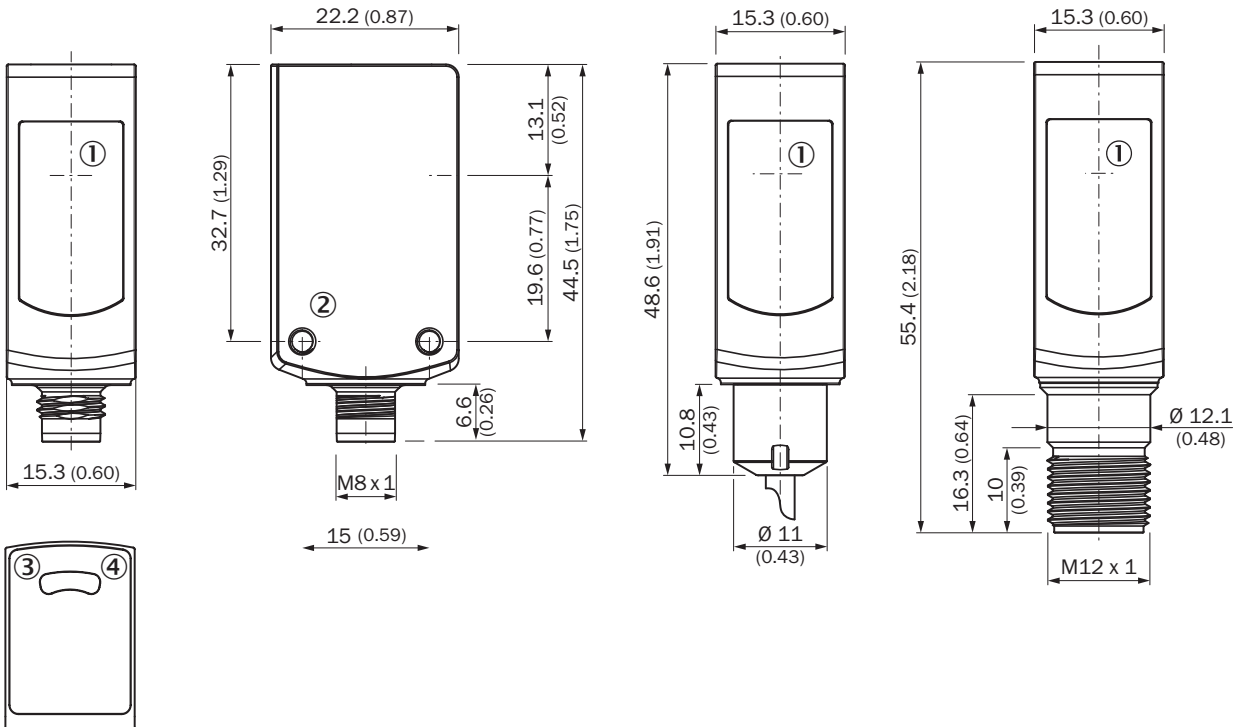

Dimensions in mm (inch)

- ① Center of optical axis
- ② Threaded mounting hole M3
- ③ LED indicator yellow: Status of received light beam
- ④ LED indicator green: Supply voltage active

Further information as well as suitable accessories, example applications and downloads such as CAD dimensional models, operating instructions and software can be found at [www.sick.com/1054712](http://www.sick.com/1054712)



SICK AG  
WALDKIRCH  
GERMANY  
SICK.COM

# SICK AT A GLANCE

SICK is a leading global technology company for intelligent sensors and integrated solutions in industrial automation. Our technologies set benchmarks, making your industrial processes more efficient, safer and more sustainable – both in logistics and manufacturing operations.

SICK combines sensor intelligence with industry expertise and certified consulting services. We provide the ideal foundation for scalable as well as tailor-made automation solutions and create added value along the entire value chain. Our close partnerships with our customers are more than just a promise: Together, we optimize productivity, improve quality, protect health and safety, and help build a sustainable future. All with empathy and trust.

Since 1946, we have been developing innovative technologies with passion and a pioneering spirit. With a global network in around 40 countries, SICK has a global presence and is always close by. The company's headquarters are located in Waldkirch near Freiburg, Germany. Our customers benefit from our understanding of both local and global requirements, which enables us to deliver tailor-made solutions

**SICK**  
Sensor Intelligence