



DATA SHEET

GSE6-N4111

G6
Photoelectric sensors

PHOTOELECTRIC SENSORS

GSE6-N4111

ORDERING INFORMATION

Type	part no.
GSE6-N4111	1052447

Further device versions and accessories at www.sick.com/G6



Illustration may differ



DETAILED TECHNICAL DATA

FEATURES

Functional principle	Through-beam photoelectric sensor	
Sensing range max.	0 m ... 15 m	
Sensing range	0 m ... 10 m	
Polarisation filter	No	
Emitted beam	Light source	PinPoint LED ¹⁾
	Type of light	Visible red light
	Light spot size (distance)	Ø 375 mm (12 m)
Key LED figures	Wave length	650 nm
	Adjustment	None
Part number of individual components	2058059 GS6-D4311 2058079 GE6-N4111	

¹⁾ Average service life: 100,000 h at T_u = +25 °C.

ELECTRONICS

Supply voltage U_B	10 V DC ... 30 V DC ¹⁾
Ripple	$\pm 10\%$ ²⁾
Current consumption	30 mA ³⁾
Protection class	III
Digital output	<p>Type NPN</p> <p>Switching mode Light/dark switching</p> <p>Switching mode selector Selectable via light/dark selector</p> <p>Signal voltage NPN HIGH/LOW Approx. $V_S / \leq 3\text{ V}$</p> <p>Output current I_{max} $\leq 100\text{ mA}$ ⁴⁾</p> <p>Response time $< 500\ \mu\text{s}$ ⁵⁾</p> <p>Switching frequency 1,000 Hz ⁶⁾</p>
Circuit protection	A ⁷⁾ B ⁸⁾ D ⁹⁾

¹⁾ Limit values when operated in short-circuit protected network: max. 8 A.

²⁾ May not fall below or exceed U_V tolerances.

³⁾ Without load.

⁴⁾ At $U_V > 24\text{ V}$, I_A max. = 50 mA.

⁵⁾ Signal transit time with resistive load.

⁶⁾ With light/dark ratio 1:1.

⁷⁾ A = V_S connections reverse-polarity protected.

⁸⁾ B = inputs and output reverse-polarity protected.

⁹⁾ D = outputs overcurrent and short-circuit protected.

MECHANICS

Housing	Rectangular
Dimensions (W x H x D)	12 mm x 31.5 mm x 21 mm
Connection	Male connector M8, 4-pin
Material	<p>Housing Plastic, ABS/PC</p> <p>Front screen Plastic, PMMA</p>
Weight	40 g

AMBIENT DATA

Enclosure rating	IP67
Ambient operating temperature	$-25\text{ °C} \dots +55\text{ °C}$ ¹⁾
Ambient temperature, storage	$-40\text{ °C} \dots +70\text{ °C}$
UL File No.	NRKH.E348498 & NRKH7.E348498

¹⁾ Temperature stability following adjustment $\pm 10\text{ °C}$.

CERTIFICATES

EU declaration of conformity	✓
UK declaration of conformity	✓
ACMA declaration of conformity	✓

Moroccan declaration of conformity	✓
China RoHS	✓
cULus certificate	✓
Photobiological safety (DIN EN 62471) certificate	✓

DIMENSIONAL DRAWING

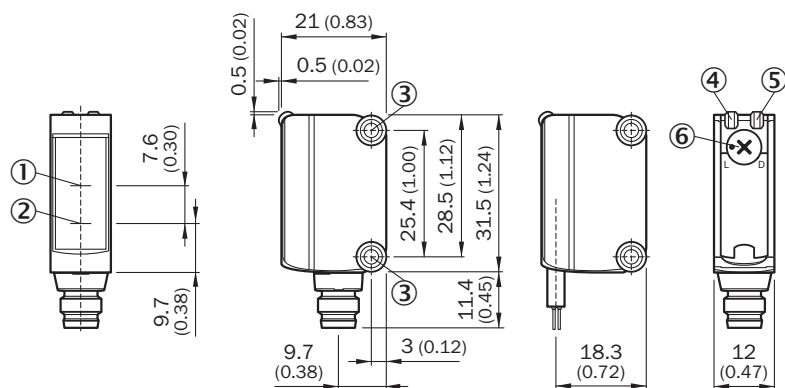

Dimensions in mm (inch)

- ① Optical axis, receiver
- ② Optical axis, sender
- ③ Mounting holes M3
- ④ LED indicator green: Supply voltage active
- ⑤ LED indicator yellow: Status of received light beam
- ⑥ Light/ dark rotary switch: L = light switching, D = dark switching

ADJUSTMENTS NO ADJUSTMENT POSSIBILITY

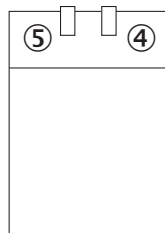

- ④ LED indicator green: Supply voltage active
- ⑤ LED indicator yellow: Status of received light beam

CONNECTION TYPE

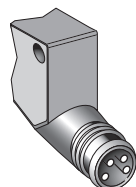

CONNECTION DIAGRAM CD-057

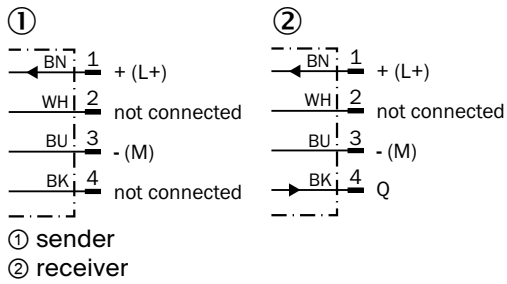

CHARACTERISTIC CURVE WITH GE6-P1111, GE6-N1111, GE6-P1111S63

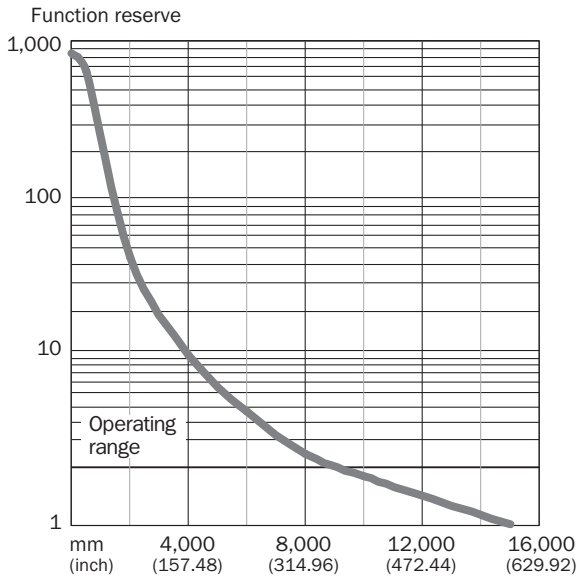

LIGHT SPOT SIZE

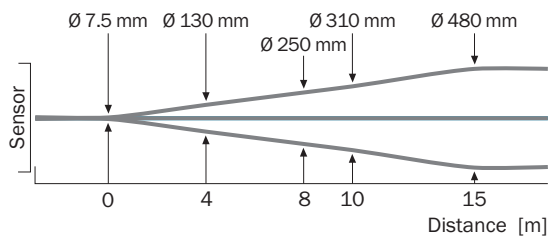

SENSING RANGE DIAGRAM

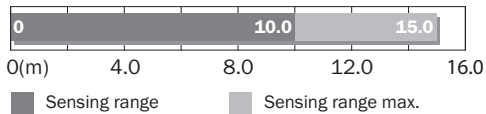

Further information as well as suitable accessories, example applications and downloads such as CAD dimensional models, operating instructions and software can be found at www.sick.com/1052447



SICK AG
WALDKIRCH
GERMANY
SICK.COM

SICK AT A GLANCE

SICK is a leading global technology company for intelligent sensors and integrated solutions in industrial automation. Our technologies set benchmarks, making your industrial processes more efficient, safer and more sustainable – both in logistics and manufacturing operations.

SICK combines sensor intelligence with industry expertise and certified consulting services. We provide the ideal foundation for scalable as well as tailor-made automation solutions and create added value along the entire value chain. Our close partnerships with our customers are more than just a promise: Together, we optimize productivity, improve quality, protect health and safety, and help build a sustainable future. All with empathy and trust.

Since 1946, we have been developing innovative technologies with passion and a pioneering spirit. With a global network in around 40 countries, SICK has a global presence and is always close by. The company's headquarters are located in Waldkirch near Freiburg, Germany. Our customers benefit from our understanding of both local and global requirements, which enables us to deliver tailor-made solutions

SICK
Sensor Intelligence