



# C40E-S117

C4000 Standard ATEX II 3G/3D

**SAFETY LIGHT CURTAINS**

**SICK**  
Sensor Intelligence.



Illustration may differ

### Ordering information

Type	part no.
C40E-S117	1050715

Other models and accessories → [www.sick.com/C4000\\_Standard\\_ATEX\\_II\\_3G\\_3D](http://www.sick.com/C4000_Standard_ATEX_II_3G_3D)

### Detailed technical data

#### Features

<b>Application</b>	Explosive areas
<b>Ex-approvals</b>	ATEX for gas: II 3G Ex nA op is IIC T4 Gc X ATEX for dust: II 3D Ex tc IIIC T135°C Dc
<b>System part</b>	Receiver
<b>Resolution</b>	20 mm
<b>Scanning range</b>	21 m
<b>Protective field height</b>	1,200 mm
<b>Synchronization</b>	Optical synchronization

#### Safety-related parameters

<b>Type</b>	Type 4 (IEC 61496-1)
<b>Safety integrity level</b>	SIL 3 (IEC 61508)
<b>Category</b>	Category 4 (EN ISO 13849)
<b>Performance level</b>	PL e (EN ISO 13849)
<b>PFH<sub>D</sub> (mean probability of a dangerous failure per hour)</b>	$15 \times 10^{-9}$ (EN ISO 13849)
<b>T<sub>M</sub> (mission time)</b>	20 years (EN ISO 13849)
<b>Safe state in the event of a fault</b>	At least one OSSD is in the OFF state.

#### Functions

<b>Protective operation</b>	✓
<b>Restart interlock</b>	✓
<b>External device monitoring (EDM)</b>	✓
<b>Beam coding</b>	✓
<b>Safe SICK device communication via EFI</b>	✓

#### Interfaces

<b>Configuration connection</b>	Female connector M8, 4-pin
<b>Configuration method</b>	PC with CDS (Configuration and Diagnostic Software)
<b>Display elements</b>	7-segment display

## Electronics

<b>Protection class</b>	III (IEC 61140)
<b>Supply voltage <math>V_S</math></b>	24 V DC (19.2 V ... 28.8 V) <sup>1)</sup>
<b>Residual ripple</b>	$\leq 10\%$ <sup>2)</sup>

<sup>1)</sup> The external voltage supply must be capable of buffering brief mains voltage failures of 20 ms as specified in EN 60204-1. Suitable power supplies are available as accessories from SICK.

<sup>2)</sup> Within the limits of  $V_S$ .

## Mechanics

<b>Dimensions</b>	See dimensional drawing
<b>Housing cross-section</b>	48 mm x 40 mm
<b>Housing material</b>	Aluminum extruded profile
<b>Weight</b>	2,560 g

## Ambient data

<b>Enclosure rating</b>	IP65 (EN 60529)
<b>Ambient operating temperature</b>	0 °C ... +55 °C
<b>Air humidity</b>	15 % ... 95 %, Non-condensing
<b>Vibration resistance</b>	5 g, 10 Hz ... 55 Hz (EN 60068-2-6)
<b>Shock resistance</b>	10 g, 16 ms (EN 60068-2-27)

## Other information

<b>Wave length</b>	850 nm
--------------------	--------

## Classifications

<b>ECLASS 5.0</b>	27272704
<b>ECLASS 5.1.4</b>	27272704
<b>ECLASS 6.0</b>	27272704
<b>ECLASS 6.2</b>	27272704
<b>ECLASS 7.0</b>	27272704
<b>ECLASS 8.0</b>	27272704
<b>ECLASS 8.1</b>	27272704
<b>ECLASS 9.0</b>	27272704
<b>ECLASS 10.0</b>	27272704
<b>ECLASS 11.0</b>	27272704
<b>ECLASS 12.0</b>	27272704
<b>ETIM 5.0</b>	EC002549
<b>ETIM 6.0</b>	EC002549
<b>ETIM 7.0</b>	EC002549
<b>ETIM 8.0</b>	EC002549
<b>UNSPSC 16.0901</b>	46171620

### Dimensional drawing

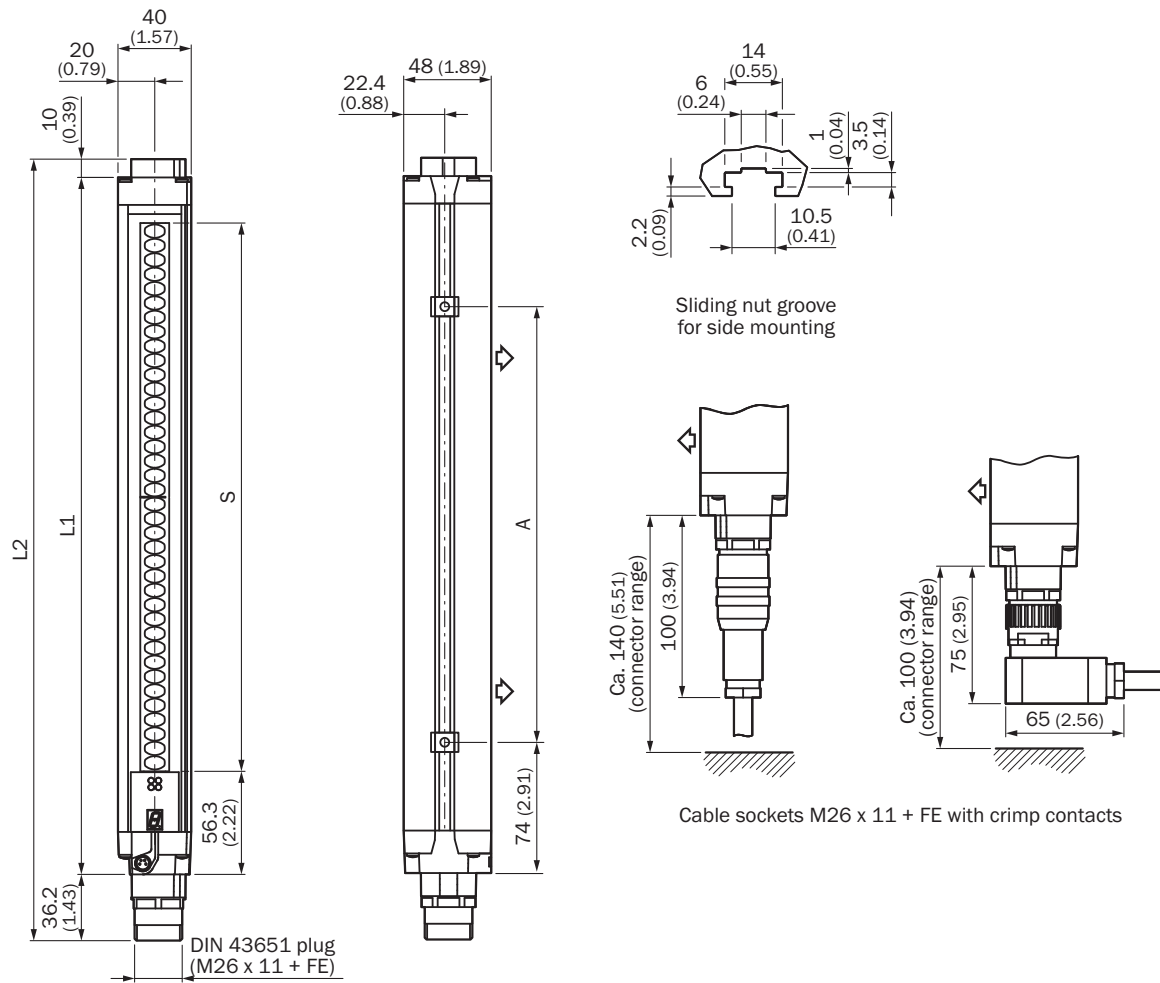



Dimensions in mm (inch)  
 illustration sender (receiver mirror image)





	L1	L2	A
300	381	427	224
450	532	578	374
600	682	728	524
750	833	879	674
900	984	1.030	824
1.050	1.134	1.180	974
1.200	1.283	1.329	1.124
1.350	1.435	1.481	1.274
1.500	1.586	1.632	1.424
1.650	1.736	1.782	1.574
1.800	1.887	1.933	1.724

### Recommended accessories







Other models and accessories → [www.sick.com/C4000\\_Standard\\_ATEX\\_II\\_3G\\_3D](http://www.sick.com/C4000_Standard_ATEX_II_3G_3D)

	Brief description	Type	part no.
device protection and care			
	<ul style="list-style-type: none"> <li><b>Product family:</b> Cleaning agents</li> <li><b>Description:</b> Cloth for cleaning optical surfaces</li> </ul>	Lens cloth	4003353
system plugs and extension modules			
	<ul style="list-style-type: none"> <li><b>Applications:</b> Functionality upgrade</li> <li><b>Compatible sensor types:</b> C4000 safety light curtains</li> </ul>	UE402	1023577

	Brief description	Type	part no.
Mounting systems			
	<ul style="list-style-type: none"> <li><b>Description:</b> Suitable for PNS75 and PNS125</li> <li><b>Packing unit:</b> 6 pieces</li> </ul>	Sliding nuts for deflector mirror	2030600
	<ul style="list-style-type: none"> <li><b>Description:</b> Mounting kit 11, exchangeable retainer, suitable for replacement of FGS</li> <li><b>Packing unit:</b> 4 pieces</li> <li><b>Suitable for:</b> Large housing profile</li> </ul>	BEF-3WNGBCST4	2021646
	<ul style="list-style-type: none"> <li><b>Description:</b> Stainless steel bracket, rotatable</li> <li><b>Material:</b> Stainless steel</li> <li><b>Details:</b> Stainless steel 1.4350, stainless steel 1.4301</li> <li><b>Packing unit:</b> 4 pieces</li> </ul>	BEF-2SMMEAES4	2023708
	<ul style="list-style-type: none"> <li><b>Description:</b> Reinforced stainless steel bracket, rotatable</li> <li><b>Material:</b> Stainless steel</li> <li><b>Details:</b> Stainless steel 1.4350, stainless steel 1.4301</li> <li><b>Packing unit:</b> 4 pieces</li> </ul>	BEF-2SMMVAES4	2026850
	<ul style="list-style-type: none"> <li><b>Description:</b> Omega bracket, rotatable, fixable with only one screw, for mounting on the swivel mount</li> <li><b>Packing unit:</b> 4 pieces</li> <li><b>Suitable for:</b> All protective field heights in large housing</li> </ul>	BEF-2SMMEAAL4	2044847
	<ul style="list-style-type: none"> <li><b>Description:</b> Mounting kit 6, side bracket, rotatable</li> <li><b>Material:</b> Zinc diecast</li> <li><b>Details:</b> Zinc diecast</li> <li><b>Packing unit:</b> 4 pieces</li> <li><b>Suitable for:</b> All protective field heights</li> </ul>	BEF-1SHABAZN4	2019506
	<ul style="list-style-type: none"> <li><b>Description:</b> Mounting kit 2, rotatable, swivel mount</li> <li><b>Material:</b> Plastic</li> <li><b>Details:</b> Polyamide PA6</li> <li><b>Packing unit:</b> 4 pieces</li> <li><b>Suitable for:</b> All protective field heights</li> </ul>	BEF-2SMMEAKU4	2019659
	<ul style="list-style-type: none"> <li><b>Description:</b> Mounting kit 1, mounting bracket, rigid, L-shaped, including fixing screws and washers</li> <li><b>Packing unit:</b> 4 pieces</li> <li><b>Suitable for:</b> All protective field heights</li> </ul>	BEF-3WNGBAST4	7021352
	<ul style="list-style-type: none"> <li><b>Description:</b> Mounting kit 3, rotatable, with shock-absorber</li> <li><b>Packing unit:</b> 4 pieces</li> </ul>	BEF-1SHADAAL4	2017752
	<ul style="list-style-type: none"> <li><b>Description:</b> Mounting kit, rotatable, telescopic, swivel mount</li> <li><b>Material:</b> Plastic</li> <li><b>Details:</b> Polyamide PA6</li> <li><b>Packing unit:</b> 2 pieces</li> <li><b>Suitable for:</b> All protective field heights in large housing</li> </ul>	BEF-0SMMEA002	2046172
	<ul style="list-style-type: none"> <li><b>Description:</b> Sliding nut set, M5, 4x</li> <li><b>Packing unit:</b> 4 pieces</li> <li><b>Items supplied:</b> Included in delivery</li> </ul>	Sliding nuts	2017550
	<ul style="list-style-type: none"> <li><b>Description:</b> Reinforced stainless steel bracket, rotatable</li> <li><b>Material:</b> Stainless steel</li> <li><b>Details:</b> Stainless steel 1.4350, stainless steel 1.4301</li> <li><b>Packing unit:</b> 2 pieces</li> </ul>	BEF-2SMMVAES2	2048373

	Brief description	Type	part no.
network devices			
		UE4740-22H0000	1046978
Commissioning aids and test equipment			
	<ul style="list-style-type: none"> <li>• <b>Product:</b> Alignment aids</li> <li>• <b>Dimensions (W x H x L):</b> 19 mm 67.3 mm 66.9 mm</li> <li>• <b>Description:</b> Laser alignment aid for various sensors, laser class 2 (IEC 60825). Do not look into the beam!</li> </ul>	AR60	1015741
	<ul style="list-style-type: none"> <li>• <b>Product:</b> Alignment aids</li> <li>• <b>Description:</b> Adapter AR60 for housing cross-section 48 mm x 40 mm</li> </ul>	AR60 adapter, 48x40	4032461
	<ul style="list-style-type: none"> <li>• <b>Product:</b> Alignment aids</li> <li>• <b>Description:</b> Adapter AR60 for housing cross-section 48 mm x 40 mm in PU3H device column</li> </ul>	AR60 adapter, 48x40, PU3H	4056731

	Brief description	Type	part no.
connectors and cables			
	<ul style="list-style-type: none"> <li><b>Description:</b> Unshielded</li> <li><b>Connection type head A:</b> Male connector, M26, 12-pin, straight, A-coded</li> <li><b>Connection systems:</b> Crimp contacts</li> <li><b>Permitted cross-section:</b> 0.5 mm<sup>2</sup> ... 1.5 mm<sup>2</sup></li> <li><b>Note:</b> 12 crimping contacts enclosed</li> </ul>	STE-0612G000GA3KMC	6021191
	<ul style="list-style-type: none"> <li><b>Description:</b> Unshielded</li> <li><b>Connection type head A:</b> Male connector, M26, 12-pin, angled, A-coded</li> <li><b>Connection systems:</b> Crimp contacts</li> <li><b>Permitted cross-section:</b> 0.5 mm<sup>2</sup> ... 1.5 mm<sup>2</sup></li> <li><b>Note:</b> 12 crimping contacts enclosed</li> </ul>	STE-0612W000GA3KMC	6021192
	<ul style="list-style-type: none"> <li><b>Description:</b> Unshielded</li> <li><b>Connection type head A:</b> Female connector, M26, 12-pin, straight, A-coded</li> <li><b>Connection systems:</b> Crimp contacts</li> <li><b>Permitted cross-section:</b> 0.5 mm<sup>2</sup> ... 1.5 mm<sup>2</sup></li> <li><b>Note:</b> 12 crimping contacts enclosed</li> </ul>	DOS-0612G000GA3KMC	6020757
	<ul style="list-style-type: none"> <li><b>Description:</b> Unshielded</li> <li><b>Connection type head A:</b> Female connector, M26, 12-pin, angled, A-coded</li> <li><b>Connection systems:</b> Crimp contacts</li> <li><b>Permitted cross-section:</b> 0.5 mm<sup>2</sup> ... 1.5 mm<sup>2</sup></li> <li><b>Note:</b> 12 crimping contacts enclosed</li> </ul>	DOS-0612W000GA3KMC	6020758
	<ul style="list-style-type: none"> <li><b>Description:</b> Unshielded</li> <li><b>Connection type head A:</b> Male connector, M8, 4-pin, straight</li> <li><b>Connection type head B:</b> Male connector, USB-A, straight</li> <li><b>Cable:</b> 2 m, 4-wire, PVC</li> </ul>	DSL-8U04G02M025KM	6034574
	<ul style="list-style-type: none"> <li><b>Description:</b> Unshielded</li> <li><b>Connection type head A:</b> Male connector, M8, 4-pin, straight</li> <li><b>Connection type head B:</b> Male connector, USB-A, straight</li> <li><b>Cable:</b> 10 m, 4-wire, PVC</li> </ul>	DSL-8U04G10M025KM	6034575
	<ul style="list-style-type: none"> <li><b>Description:</b> Sensor/actuator cable, unshielded</li> <li><b>Connection type head A:</b> Female connector, M26, 12-pin, straight</li> <li><b>Connection type head B:</b> Flying leads</li> <li><b>Signal type:</b> Sensor/actuator cable</li> <li><b>Cable:</b> 5 m, 12-wire, PVC</li> <li><b>Connection systems:</b> Flying leads</li> <li><b>Application:</b> Uncontaminated zones, Zones with chemicals</li> </ul>	DOL-0612G05M075KM	2022545
	<ul style="list-style-type: none"> <li><b>Description:</b> Sensor/actuator cable, unshielded</li> <li><b>Connection type head A:</b> Female connector, M26, 12-pin, straight</li> <li><b>Connection type head B:</b> Flying leads</li> <li><b>Signal type:</b> Sensor/actuator cable</li> <li><b>Cable:</b> 10 m, 12-wire, PVC</li> <li><b>Connection systems:</b> Flying leads</li> <li><b>Application:</b> Uncontaminated zones, Zones with chemicals</li> </ul>	DOL-0612G10M075KM	2022547
	<ul style="list-style-type: none"> <li><b>Description:</b> Sensor/actuator cable, unshielded</li> <li><b>Connection type head A:</b> Female connector, M26, 12-pin, straight</li> <li><b>Connection type head B:</b> Flying leads</li> <li><b>Signal type:</b> Sensor/actuator cable</li> <li><b>Cable:</b> 15 m, 12-wire, PVC</li> <li><b>Connection systems:</b> Flying leads</li> <li><b>Application:</b> Uncontaminated zones, Zones with chemicals</li> </ul>	DOL-0612G15M075KM	2022548
	<ul style="list-style-type: none"> <li><b>Description:</b> Sensor/actuator cable, unshielded</li> <li><b>Connection type head A:</b> Female connector, M26, 12-pin, straight</li> <li><b>Connection type head B:</b> Flying leads</li> <li><b>Signal type:</b> Sensor/actuator cable</li> <li><b>Cable:</b> 2.5 m, 12-wire, PVC</li> <li><b>Connection systems:</b> Flying leads</li> <li><b>Application:</b> Uncontaminated zones, Zones with chemicals</li> </ul>	DOL-0612G2M5075KM	2022544
	<ul style="list-style-type: none"> <li><b>Description:</b> Sensor/actuator cable, unshielded</li> <li><b>Connection type head A:</b> Female connector, M26, 12-pin, straight</li> <li><b>Connection type head B:</b> Flying leads</li> <li><b>Signal type:</b> Sensor/actuator cable</li> <li><b>Cable:</b> 20 m, 12-wire, PVC</li> <li><b>Connection systems:</b> Flying leads</li> </ul>	DOL-0612G20M075KM	2022549

	Brief description	Type	part no.
	<ul style="list-style-type: none"> <li>• <b>Application:</b> Uncontaminated zones, Zones with chemicals</li> <li>• <b>Description:</b> Sensor/actuator cable, unshielded</li> <li>• <b>Connection type head A:</b> Female connector, M26, 12-pin, straight</li> <li>• <b>Connection type head B:</b> Flying leads</li> <li>• <b>Signal type:</b> Sensor/actuator cable</li> <li>• <b>Cable:</b> 30 m, 12-wire, PVC</li> <li>• <b>Connection systems:</b> Flying leads</li> <li>• <b>Application:</b> Uncontaminated zones, Zones with chemicals</li> </ul>	DOL-0612G30M075KM0	2022550
	<ul style="list-style-type: none"> <li>• <b>Description:</b> Sensor/actuator cable, unshielded</li> <li>• <b>Connection type head A:</b> Female connector, M26, 12-pin, straight</li> <li>• <b>Connection type head B:</b> Flying leads</li> <li>• <b>Signal type:</b> Sensor/actuator cable</li> <li>• <b>Cable:</b> 50 m, PVC</li> <li>• <b>Connection systems:</b> Flying leads</li> <li>• <b>Application:</b> Uncontaminated zones, Zones with chemicals</li> </ul>	DOL-0612G50M075KM0	2033548
	<ul style="list-style-type: none"> <li>• <b>Description:</b> Sensor/actuator cable, unshielded</li> <li>• <b>Connection type head A:</b> Female connector, M26, 12-pin, straight</li> <li>• <b>Connection type head B:</b> Flying leads</li> <li>• <b>Signal type:</b> Sensor/actuator cable</li> <li>• <b>Cable:</b> 7.5 m, 12-wire, PVC</li> <li>• <b>Connection systems:</b> Flying leads</li> <li>• <b>Application:</b> Uncontaminated zones, Zones with chemicals</li> </ul>	DOL-0612G7M5075KM0	2022546
	<ul style="list-style-type: none"> <li>• <b>Description:</b> Unshielded</li> <li>• <b>Connection type head A:</b> Female connector, M26, 12-pin, straight</li> <li>• <b>Connection type head B:</b> Flying leads</li> <li>• <b>Cable:</b> 20 m, PVC</li> <li>• <b>Connection systems:</b> Flying leads</li> <li>• <b>Note:</b> Without EFI: Pin 9 and 10 not connected</li> <li>• <b>Application:</b> Uncontaminated zones, Zones with chemicals</li> </ul>	DOL-0610G20M075KM0	2046890
	<ul style="list-style-type: none"> <li>• <b>Description:</b> Unshielded</li> <li>• <b>Connection type head A:</b> Female connector, M26, 12-pin, straight</li> <li>• <b>Connection type head B:</b> Flying leads</li> <li>• <b>Cable:</b> 5 m, PVC</li> <li>• <b>Connection systems:</b> Flying leads</li> <li>• <b>Note:</b> Without EFI: Pin 9 and 10 not connected</li> <li>• <b>Application:</b> Uncontaminated zones, Zones with chemicals</li> </ul>	DOL-0610G05M075KM0	2046888
	<ul style="list-style-type: none"> <li>• <b>Description:</b> Unshielded</li> <li>• <b>Connection type head A:</b> Female connector, M26, 12-pin, straight</li> <li>• <b>Connection type head B:</b> Flying leads</li> <li>• <b>Cable:</b> 10 m, PVC</li> <li>• <b>Connection systems:</b> Flying leads</li> <li>• <b>Note:</b> Without EFI: Pin 9 and 10 not connected</li> <li>• <b>Application:</b> Uncontaminated zones, Zones with chemicals</li> </ul>	DOL-0610G10M075KM0	2046889
	<ul style="list-style-type: none"> <li>• <b>Description:</b> Unshielded</li> <li>• <b>Connection type head A:</b> Flying leads</li> <li>• <b>Connection type head B:</b> Flying leads</li> <li>• <b>Items supplied:</b> By the meter</li> <li>• <b>Cable:</b> 12-wire, PVC</li> <li>• <b>Note:</b> max. 100 m, fitting for EFI connections</li> </ul>	Connecting cable	6021437

## SICK AT A GLANCE

SICK is one of the leading manufacturers of intelligent sensors and sensor solutions for industrial applications. A unique range of products and services creates the perfect basis for controlling processes securely and efficiently, protecting individuals from accidents and preventing damage to the environment.

We have extensive experience in a wide range of industries and understand their processes and requirements. With intelligent sensors, we can deliver exactly what our customers need. In application centers in Europe, Asia and North America, system solutions are tested and optimized in accordance with customer specifications. All this makes us a reliable supplier and development partner.

Comprehensive services complete our offering: SICK LifeTime Services provide support throughout the machine life cycle and ensure safety and productivity.

For us, that is “Sensor Intelligence.”

## WORLDWIDE PRESENCE:

Contacts and other locations –[www.sick.com](http://www.sick.com)