



# DT50-N1113

Dx50

TIME-OF-FLIGHT SENSORS

**SICK**  
Sensor Intelligence.



## Ordering information

Type	part no.
DT50-N1113	1047396

Other models and accessories → [www.sick.com/Dx50](http://www.sick.com/Dx50)



## Detailed technical data

### Features

<b>Measuring range</b>	200 mm ... 10,000 mm, 90% remission factor 200 mm ... 6,500 mm, 18% reflection factor 200 mm ... 4,000 mm, 6% remission factor
<b>Target</b>	Natural objects
<b>Resolution</b>	1,000 µm
<b>Repeatability</b>	≥ 2.5 mm <sup>1) 2) 3)</sup>
<b>Measurement accuracy</b>	± 10 mm <sup>4)</sup>
<b>Response time</b>	20 ms ... 30 ms, 20 ms / 30 ms <sup>3) 5)</sup>
<b>Output time</b>	≥ 4 ms <sup>6)</sup>
<b>Emitted beam</b>	
Light source	Laser, red
Type of light	Visible red light
Typ. light spot size (distance)	15 mm x 15 mm (10 m)
<b>Key laser figures</b>	
Normative reference	IEC 60825-1:2014, EN 60825-1:2014
Laser class	2 <sup>7)</sup>
	8)
Average laser service life (at 25 °C)	100,000 h

- 1) Equivalent to 1 σ.
- 2) 6% ... 90% remission factor.
- 3) Dependent on the averaging setting: fast/slow.
- 4) 90% remission factor.
- 5) Lateral entry of the object into the measuring range.
- 6) Continuous change of distance in measuring range.
- 7) Do not intentionally look into the laser beam. Never point the laser beam at people's eyes.
- 8) Wavelength: 658 nm; max. output: 180 mW; pulse duration: 5 ns; duty cycle: 1/200.

<b>Additional function</b>	Set moving average: fast/slow Switching mode: distance to object (DtO) Teach-in, scaling and inversion of digital output Set hysteresis Teach-in, scaling and inversion of analog output Multifunctional input: laser off / external teach / deactivated Switch-off display Reset to factory default Lock user interface	
<b>Safety-related parameters</b>		
	MTTF <sub>D</sub>	101 years
	DC <sub>avg</sub>	0%

- 1) Equivalent to 1  $\sigma$ .
- 2) 6% ... 90% remission factor.
- 3) Dependent on the averaging setting: fast/slow.
- 4) 90% remission factor.
- 5) Lateral entry of the object into the measuring range.
- 6) Continuous change of distance in measuring range.
- 7) Do not intentionally look into the laser beam. Never point the laser beam at people's eyes.
- 8) Wavelength: 658 nm; max. output: 180 mW; pulse duration: 5 ns; duty cycle: 1/200.

## Interfaces

<b>Digital output</b>		
	Number	1 <sup>1) 2)</sup>
	Type	NPN
	Maximum output current I <sub>A</sub>	≤ 100 mA
<b>Analog output</b>		
	Number	1
	Type	Current output
	Current	4 mA ... 20 mA, ≤ 300 $\Omega$
	Resolution	16 bit
<b>Multifunctional input (MF)</b>		1 x <sup>3) 4)</sup>
<b>Hysteresis</b>		10 mm ... 1,000 mm

- 1) Output Q short-circuit protected.
- 2) NPN: HIGH = < 2.5 V / LOW = V<sub>S</sub>.
- 3) Response time ≤ 15ms.
- 4) NPN: HIGH = ≤ 2.5 V / LOW = V<sub>S</sub>.

## Electronics

<b>Supply voltage U<sub>B</sub></b>	DC 10 V ... 30 V <sup>1) 2)</sup>
<b>Power consumption</b>	≤ 2.1 W <sup>3)</sup>
<b>Ripple</b>	≤ 5 V <sub>pp</sub> <sup>4)</sup>
<b>Initialization time</b>	≤ 250 ms
<b>Warm-up time</b>	≤ 15 min
<b>Display</b>	LC display, 2 x LED

- 1) Limit values, reverse-polarity protected, operation in short-circuit protected network: max. 8 A.
- 2) For DT50-xxxx4: V<sub>S</sub> > 15 V.
- 3) Without load.
- 4) May not fall short of or exceed V<sub>S</sub> tolerances.

<b>Enclosure rating</b>	IP65
<b>Protection class</b>	III
<b>Connection type</b>	Male connector, M12, 5-pin

<sup>1)</sup> Limit values, reverse-polarity protected, operation in short-circuit protected network: max. 8 A.

<sup>2)</sup> For DT50-xxx4:  $V_S > 15$  V.

<sup>3)</sup> Without load.

<sup>4)</sup> May not fall short of or exceed  $V_S$  tolerances.

## Mechanics

<b>Dimensions (W x H x D)</b>	36.1 mm x 62.7 mm x 57.7 mm
<b>Housing material</b>	Metal (zinc diecast)
<b>Window material</b>	Plastic (PMMA)
<b>Weight</b>	200 g

## Ambient data

<b>Ambient temperature, operation</b>	-30 °C ... +65 °C -30 °C ... +80 °C, operation with 2 cooling plates -30 °C ... +140 °C, operation with 2 cooling plates and protection filter
<b>Ambient temperature, storage</b>	-40 °C ... +75 °C
<b>Max. rel. humidity (not condensing)</b>	≤ 95 %
<b>Typ. Ambient light immunity</b>	40,000 lx
<b>Vibration resistance</b>	EN 60068-2-6, EN 60068-2-64
<b>Shock resistance</b>	EN 60068-2-27

## Certificates

<b>EU declaration of conformity</b>	✓
<b>UK declaration of conformity</b>	✓
<b>ACMA declaration of conformity</b>	✓
<b>Moroccan declaration of conformity</b>	✓
<b>China RoHS</b>	✓
<b>cULus certificate</b>	✓

## Classifications

<b>ECLASS 5.0</b>	27270801
<b>ECLASS 5.1.4</b>	27270801
<b>ECLASS 6.0</b>	27270801
<b>ECLASS 6.2</b>	27270801
<b>ECLASS 7.0</b>	27270801
<b>ECLASS 8.0</b>	27270801
<b>ECLASS 8.1</b>	27270801
<b>ECLASS 9.0</b>	27270801
<b>ECLASS 10.0</b>	27270801
<b>ECLASS 11.0</b>	27270801
<b>ECLASS 12.0</b>	27270916

<b>ETIM 5.0</b>	EC001825
<b>ETIM 6.0</b>	EC001825
<b>ETIM 7.0</b>	EC001825
<b>ETIM 8.0</b>	EC001825
<b>UNSPSC 16.0901</b>	41111613

### Dimensional drawing

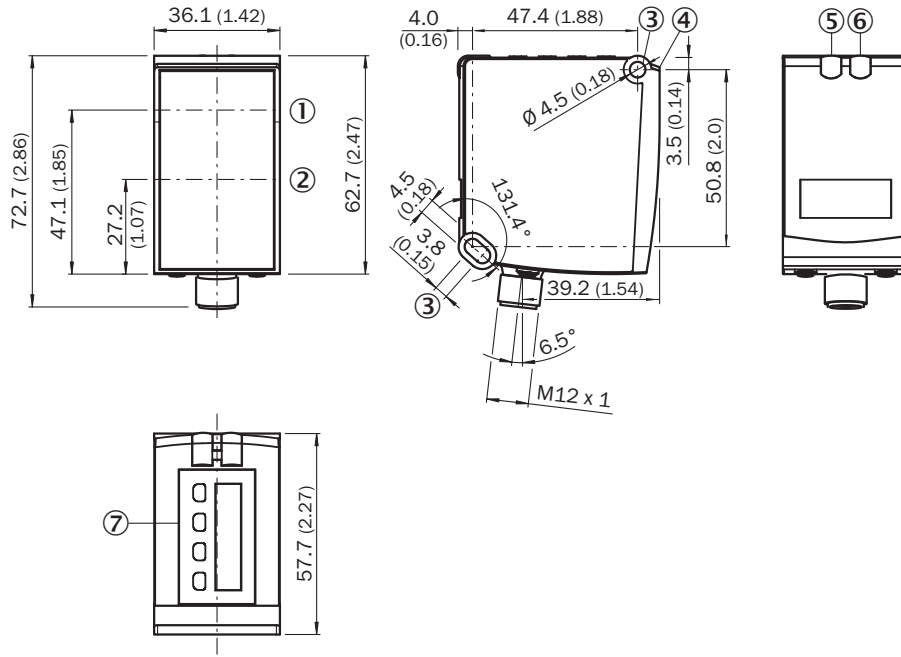

Dimensions in mm (inch)

- ① optical axis, sender
- ② optical axis, receiver
- ③ fixing hole
- ④ Reference surface = 0 mm
- ⑤ Status indicator digital output Q<sub>1</sub> (orange)
- ⑥ DT50 / DT50 Hi/DL50: Status display for supply voltage active (green), DS50 / DL50 Hi: Status display of digital output Q<sub>2</sub> (orange)
- ⑦ Control elements and display

### Connection type Plug, M12, 5-pin

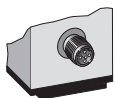

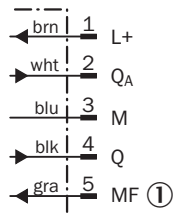

### Connection diagram



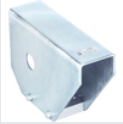

① Multifunctional input (MF)

### Recommended accessories

Other models and accessories → [www.sick.com/Dx50](http://www.sick.com/Dx50)

	Brief description	Type	part no.
device protection and care			
	<ul style="list-style-type: none"> <li><b>Description:</b> Weather protection hood for Dx35 / Dx50 / Dx50-2 / Dx80</li> </ul>	OBW-KHS-M02	2050205
	<ul style="list-style-type: none"> <li><b>Description:</b> Cooling plate for Dx50/Dx50-2/DT20 (for water cooling)</li> <li><b>Usable for:</b> DT20 Hi, Dx50, Dx50-2</li> </ul>	BEF-KP-Dx50/DT20	2055755
	<ul style="list-style-type: none"> <li><b>Description:</b> Thermal shield for Dx50 with NIR filter, for use with 2x cold plate BEF-KP-Dx50/DT20</li> </ul>	Heat protection filter for Dx50	2057137

	Brief description	Type	part no.
connectors and cables			
	<ul style="list-style-type: none"> <li><b>Description:</b> HIPERFACE<sup>®</sup>, shielded</li> <li><b>Connection type head A:</b> Female connector, M12, 5-pin, angled, A-coded</li> <li><b>Connection type head B:</b> Flying leads</li> <li><b>Signal type:</b> HIPERFACE<sup>®</sup></li> <li><b>Cable:</b> 5 m, 5-wire, PUR, halogen-free</li> <li><b>Note:</b> Sensor/actuator cable</li> <li><b>Application:</b> Drag chain operation, Zones with oils and lubricants</li> </ul>	DOL-1205-W05MAC	6041751
	<ul style="list-style-type: none"> <li><b>Description:</b> Sensor/actuator cable, unshielded</li> <li><b>Connection type head A:</b> Female connector, M12, 5-pin, angled, A-coded</li> <li><b>Connection type head B:</b> Flying leads</li> <li><b>Signal type:</b> Sensor/actuator cable</li> <li><b>Cable:</b> 2 m, 5-wire, PVC</li> <li><b>Application:</b> Uncontaminated zones, Zones with chemicals</li> </ul>	YG2A15-020VB5XLEAX	2096215
	<ul style="list-style-type: none"> <li><b>Description:</b> Sensor/actuator cable, unshielded</li> <li><b>Connection type head A:</b> Female connector, M12, 5-pin, straight, A-coded</li> <li><b>Connection type head B:</b> Flying leads</li> <li><b>Signal type:</b> Sensor/actuator cable</li> <li><b>Cable:</b> 2 m, 5-wire, PUR, halogen-free</li> <li><b>Application:</b> Drag chain operation, Zones with oils and lubricants, Robot, Drag chain operation</li> </ul>	YF2A15-020UB5XLEAX	2095617
	<ul style="list-style-type: none"> <li><b>Description:</b> Sensor/actuator cable, unshielded</li> <li><b>Connection type head A:</b> Female connector, M12, 5-pin, angled, A-coded</li> <li><b>Connection type head B:</b> Flying leads</li> <li><b>Signal type:</b> Sensor/actuator cable</li> <li><b>Cable:</b> 2 m, 5-wire, PUR, halogen-free</li> <li><b>Application:</b> Drag chain operation, Zones with oils and lubricants, Robot, Drag chain operation</li> </ul>	YG2A15-020UB5XLEAX	2095772
	<ul style="list-style-type: none"> <li><b>Description:</b> Sensor/actuator cable, unshielded</li> <li><b>Connection type head A:</b> Female connector, M12, 5-pin, straight, A-coded</li> <li><b>Connection type head B:</b> Flying leads</li> <li><b>Signal type:</b> Sensor/actuator cable</li> <li><b>Cable:</b> 2 m, 5-wire, PVC</li> <li><b>Application:</b> Uncontaminated zones, Zones with chemicals</li> </ul>	YF2A15-020VB5XLEAX	2096239
	<ul style="list-style-type: none"> <li><b>Description:</b> Sensor/actuator cable, unshielded</li> <li><b>Connection type head A:</b> Female connector, M12, 5-pin, angled, A-coded</li> <li><b>Connection type head B:</b> Flying leads</li> <li><b>Signal type:</b> Sensor/actuator cable</li> <li><b>Cable:</b> 0.6 m, 5-wire, PUR, halogen-free</li> <li><b>Application:</b> Drag chain operation, Zones with oils and lubricants, Robot, Drag chain operation</li> </ul>	YG2A15-C60UB5XLEAX	2145540
	<ul style="list-style-type: none"> <li><b>Description:</b> Sensor/actuator cable, unshielded</li> <li><b>Connection type head A:</b> Female connector, M12, 5-pin, angled, A-coded</li> <li><b>Connection type head B:</b> Flying leads</li> <li><b>Signal type:</b> Sensor/actuator cable</li> <li><b>Cable:</b> 3 m, 5-wire, PUR, halogen-free</li> <li><b>Application:</b> Drag chain operation, Zones with oils and lubricants, Robot, Drag chain operation</li> </ul>	YG2A15-030UB5XLEAX	2145543
	<ul style="list-style-type: none"> <li><b>Description:</b> Sensor/actuator cable, unshielded</li> <li><b>Connection type head A:</b> Female connector, M12, 5-pin, angled, A-coded</li> <li><b>Connection type head B:</b> Flying leads</li> <li><b>Signal type:</b> Sensor/actuator cable</li> <li><b>Cable:</b> 1 m, 5-wire, PUR, halogen-free</li> <li><b>Application:</b> Drag chain operation, Zones with oils and lubricants, Robot, Drag chain operation</li> </ul>	YG2A15-010UB5XLEAX	2145541
	<ul style="list-style-type: none"> <li><b>Description:</b> Sensor/actuator cable, unshielded</li> <li><b>Connection type head A:</b> Female connector, M12, 5-pin, angled, A-coded</li> <li><b>Connection type head B:</b> Flying leads</li> <li><b>Signal type:</b> Sensor/actuator cable</li> <li><b>Cable:</b> 0.6 m, 5-wire, PVC</li> <li><b>Application:</b> Uncontaminated zones, Zones with chemicals</li> </ul>	YG2A15-C60VB5XLEAX	2145573
	<ul style="list-style-type: none"> <li><b>Description:</b> Sensor/actuator cable, unshielded</li> <li><b>Connection type head A:</b> Female connector, M12, 5-pin, angled, A-coded</li> <li><b>Connection type head B:</b> Flying leads</li> <li><b>Signal type:</b> Sensor/actuator cable</li> <li><b>Cable:</b> 1 m, 5-wire, PVC</li> <li><b>Application:</b> Uncontaminated zones, Zones with chemicals</li> </ul>	YG2A15-010VB5XLEAX	2145574
	<ul style="list-style-type: none"> <li><b>Description:</b> Sensor/actuator cable, unshielded</li> <li><b>Connection type head A:</b> Female connector, M12, 5-pin, angled, A-coded</li> <li><b>Connection type head B:</b> Flying leads</li> <li><b>Signal type:</b> Sensor/actuator cable</li> <li><b>Cable:</b> 3 m, 5-wire, PVC</li> </ul>	YG2A15-030VB5XLEAX	2145575

	Brief description	Type	part no.
	<ul style="list-style-type: none"> <li>• <b>Application:</b> Untaminated zones, Zones with chemicals</li> <li>• <b>Description:</b> Sensor/actuator cable, unshielded</li> <li>• <b>Connection type head A:</b> Female connector, M12, 5-pin, straight, A-coded</li> <li>• <b>Connection type head B:</b> Flying leads</li> <li>• <b>Signal type:</b> Sensor/actuator cable</li> <li>• <b>Cable:</b> 0.6 m, 5-wire, PVC</li> <li>• <b>Application:</b> Untaminated zones, Zones with chemicals</li> </ul>	YF2A15-C60VB5XLEAX	2145570
	<ul style="list-style-type: none"> <li>• <b>Description:</b> Sensor/actuator cable, unshielded</li> <li>• <b>Connection type head A:</b> Female connector, M12, 5-pin, straight, A-coded</li> <li>• <b>Connection type head B:</b> Flying leads</li> <li>• <b>Signal type:</b> Sensor/actuator cable</li> <li>• <b>Cable:</b> 3 m, 5-wire, PVC</li> <li>• <b>Application:</b> Untaminated zones, Zones with chemicals</li> </ul>	YF2A15-030VB5XLEAX	2145572

## SICK AT A GLANCE

SICK is one of the leading manufacturers of intelligent sensors and sensor solutions for industrial applications. A unique range of products and services creates the perfect basis for controlling processes securely and efficiently, protecting individuals from accidents and preventing damage to the environment.

We have extensive experience in a wide range of industries and understand their processes and requirements. With intelligent sensors, we can deliver exactly what our customers need. In application centers in Europe, Asia and North America, system solutions are tested and optimized in accordance with customer specifications. All this makes us a reliable supplier and development partner.

Comprehensive services complete our offering: SICK LifeTime Services provide support throughout the machine life cycle and ensure safety and productivity.

For us, that is “Sensor Intelligence.”

## WORLDWIDE PRESENCE:

Contacts and other locations –[www.sick.com](http://www.sick.com)