



LMS123-10000 Security

LMS1xx

2D LIDAR SENSORS

SICK
Sensor Intelligence.



Ordering information

Type	part no.
LMS123-10000 Security	1044321

Other models and accessories → www.sick.com/LMS1xx



Detailed technical data

Features

Application	Security, Indoor
Light source	Infrared (905 nm)
Laser class	1 (IEC 60825-1:2014, EN 60825-1:2014+A11:2021)
Aperture angle	Horizontal 270°
Scanning frequency	25 Hz 50 Hz
Angular resolution	Horizontal 0.25° 0.5°
Heating	No
Working range	0.5 m ... 20 m
Scanning range	At 10% remission factor 18 m At 90% remission factor 20 m
Amount of evaluated echoes	2
Fog correction	Yes

Mechanics/electronics

Connection type	1 x system plug with screw terminal block
Supply voltage	9 V DC ... 30 V DC
Power consumption	Typ. 8 W
Housing color	Signal white (RAL 9003)
Enclosure rating	IP65 (EN 60529, Section 14.2.5)
Protection class	III (EN 61010-1:2010-10)
Weight	1.1 kg
Dimensions (L x W x H)	105 mm x 102 mm x 152 mm

MTBF	> 100 years
MTTFd	> 100 years

Safety-related parameters

MTTF_D	> 100 years
-------------------------	-------------

Performance

Response time	≥ 20 ms
Detectable object shape	Almost any
Systematic error	± 30 mm ¹⁾
Statistical error	12 mm ¹⁾
Integrated application	Field evaluation Security conform parameterization Easy Teach lite and pro
Number of field sets	10 fields
Simultaneous evaluation cases	10

¹⁾ Typical value; actual value depends on environmental conditions.

Interfaces

Ethernet	Function	✓, TCP/IP
	Data transmission rate	Data interface (read result output) 10/100 MBit/s
Serial	Function	✓, RS-232
	Data transmission rate	Service interface 9.6 kBaud ... 115.2 kBaud
CAN	Function	✓ Extension of outputs
Digital inputs/outputs	Inputs	4 digital
	Outputs	3 (2 relay, 1 digital)
Optical indicators		7-segment display (plus 5 LEDs showing device status, contamination warning and initial condition)

Ambient data

Remission factor	3 % ... > 1,000 % (reflectors)
Electromagnetic compatibility (EMC)	EN 61000-6-2:2005 / EN 61000-6-3:2007+A1:2011
Vibration resistance	EN 60068-2-6 (1995-04)
Shock resistance	EN 60068-2-27 (1993-03)
Ambient operating temperature	0 °C ... +50 °C
Storage temperature	-30 °C ... +70 °C
Ambient light immunity	80,000 lx

General notes

Note on use	The sensor does not constitute a safety component as defined by relevant legislation on machine safety.
--------------------	---

Certificates

EU declaration of conformity	✓
-------------------------------------	---

UK declaration of conformity	✓
ACMA declaration of conformity	✓
China RoHS	✓
cTUVus certificate	✓
Information according to Art. 3 of Data Act (Regulation EU 2023/2854)	✓

Classifications

ECLASS 5.0	27270990
ECLASS 5.1.4	27270990
ECLASS 6.0	27270913
ECLASS 6.2	27270913
ECLASS 7.0	27270913
ECLASS 8.0	27270913
ECLASS 8.1	27270913
ECLASS 9.0	27270913
ECLASS 10.0	27270913
ECLASS 11.0	27270913
ECLASS 12.0	27270913
ETIM 5.0	EC002550
ETIM 6.0	EC002550
ETIM 7.0	EC002550
ETIM 8.0	EC002550
UNSPSC 16.0901	41111615

Dimensional drawing

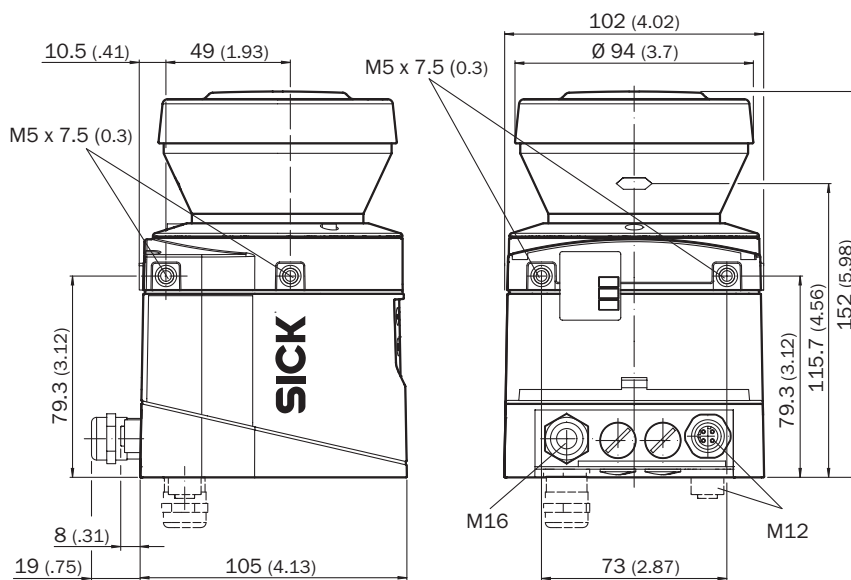

Dimensions in mm (inch)

Working range diagram

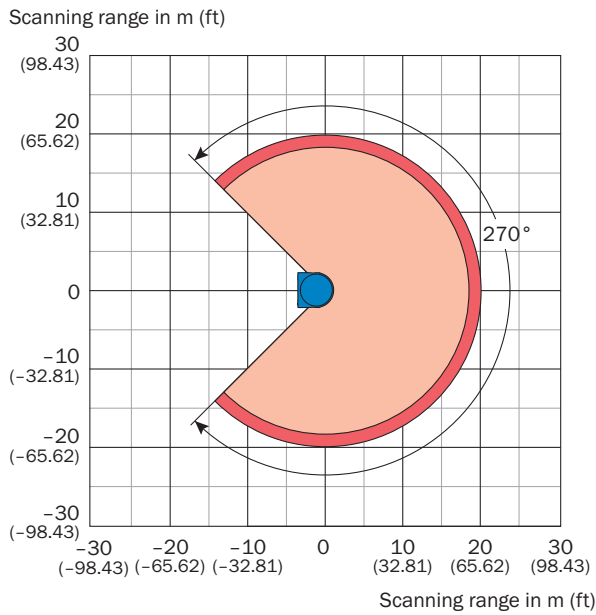

- Scanning range max. 20 m (65.62 ft)
- Scanning range for objects up to 10 % remission 18 m (59.06 ft)

Connection type Ethernet

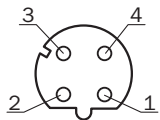

M12 female connector, 4-pin, D-coded

- ① TX+
- ② RX+
- ③ TX-
- ④ RX-

PIN assignment Service interface

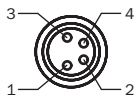







female connector M8, 4-pin

- ① Reserved
- ② RxD AUX
- ③ GND RS
- ④ TxD AUX

Recommended accessories

Other models and accessories → www.sick.com/LMS1xx

	Brief description	Type	part no.
Mounting systems			
	<ul style="list-style-type: none"> Description: Mounting bracket for rear mounting on wall or machine Material: Anodized aluminum Details: AlMg3, black anodized Packing unit: 1 piece Items supplied: Mounting bracket, 4 x M5 x 10 countersunk screws 	Mounting kit 1a	2034324
	<ul style="list-style-type: none"> Description: Mounting bracket for rear mounting on wall or machine with protection of optics hood Material: Anodized aluminum Details: AlMg3, black anodized Packing unit: 1 piece Items supplied: Mounting bracket, 4 x M5 x 10 countersunk screws 	Mounting kit 1b	2034325
	<ul style="list-style-type: none"> Description: Mounting bracket, adjustable lateral axis, only in conjunction with mounting kit 1a (2034324) or 1b (2034325) Material: Anodized aluminum Details: AlMg3, black anodized Packing unit: 1 piece Items supplied: Mounting bracket, 4 x countersunk screws with washers M4 x 10, 4 x spring washer 	Mounting kit 2	2039302
	<ul style="list-style-type: none"> Description: Mounting plate, adjustable longitudinal axis, only in conjunction with mounting kit 2 (2039302) Material: Anodized aluminum Details: AlMg3, black anodized Packing unit: 1 piece Items supplied: Mounting plate, 2 x countersunk screws with washers M4 x 10, 2 x spring washer 	Mounting kit 3	2039303
connectors and cables			
	<ul style="list-style-type: none"> Connection type head A: Male connector, M12, 4-pin, straight, D-coded Connection type head B: Male connector, RJ45, 4-pin, straight Signal type: Ethernet, PROFINET Cable: 5 m, 4-wire, PUR, halogen-free Description: Ethernet, shielded, PROFINET Application: Drag chain operation, Zones with oils and lubricants 	YM2D24-050P-N1MRJA4	2106184
	<ul style="list-style-type: none"> Connection type head A: Flying leads Connection type head B: Flying leads Items supplied: By the meter Cable: 15-wire, AWG20, PVC Description: Unshielded Note: On 100 m reel 	Connecting cable	6030795

SICK AT A GLANCE

SICK is one of the leading manufacturers of intelligent sensors and sensor solutions for industrial applications. A unique range of products and services creates the perfect basis for controlling processes securely and efficiently, protecting individuals from accidents and preventing damage to the environment.

We have extensive experience in a wide range of industries and understand their processes and requirements. With intelligent sensors, we can deliver exactly what our customers need. In application centers in Europe, Asia and North America, system solutions are tested and optimized in accordance with customer specifications. All this makes us a reliable supplier and development partner.

Comprehensive services complete our offering: SICK LifeTime Services provide support throughout the machine life cycle and ensure safety and productivity.

For us, that is “Sensor Intelligence.”

WORLDWIDE PRESENCE:

Contacts and other locations –www.sick.com