



WLG4-3F3234S05

W4

PHOTOELECTRIC SENSORS

SICK
Sensor Intelligence.



Illustration may differ

Ordering information

Type	part no.
WLG4-3F3234S05	1043538

Other models and accessories → www.sick.com/W4

Detailed technical data

Features

Functional principle	Photoelectric retro-reflective sensor
Sensing range max.	0.01 m ... 4 m ¹⁾
Sensing range	0.02 m ... 3.5 m ¹⁾
Polarisation filter	Yes
Emitted beam	
Light source	PinPoint LED ²⁾
Type of light	Visible red light
Key LED figures	
Wave length	650 nm
Adjustment	Cable, Single teach-in button
Special features	Without polarisation filter
Special applications	Detecting transparent objects
AutoAdapt	✓

¹⁾ Reflector PL80A.

²⁾ Average service life: 100,000 h at T_J = +25 °C.

Electronics

Supply voltage U_B	10 V DC ... 30 V DC ¹⁾
Ripple	< 5 V _{pp} ²⁾
Current consumption	20 mA ³⁾

¹⁾ Limit values.

²⁾ May not fall below or exceed U_V tolerances.

³⁾ Without load.

⁴⁾ Signal transit time with resistive load.

⁵⁾ With light/dark ratio 1:1.

⁶⁾ A = V_S connections reverse-polarity protected.

⁷⁾ C = interference suppression.

⁸⁾ D = outputs overcurrent and short-circuit protected.

Protection class	III
Digital output	
Type	PNP
Switching mode	Dark switching
Output current I_{max}	≤ 100 mA
Response time	< 0.5 ms ⁴⁾
Switching frequency	1,000 Hz ⁵⁾
Attenuation along light beam	> 8 %
Circuit protection	A ⁶⁾ C ⁷⁾ D ⁸⁾

1) Limit values.

2) May not fall below or exceed U_V tolerances.

3) Without load.

4) Signal transit time with resistive load.

5) With light/dark ratio 1:1.

6) A = V_S connections reverse-polarity protected.

7) C = interference suppression.

8) D = outputs overcurrent and short-circuit protected.

Mechanics

Housing	Rectangular
Design detail	Flat
Dimensions (W x H x D)	16 mm x 39.5 mm x 12 mm
Connection	Cable with M8 male connector, 4-pin ¹⁾
Connection detail	
Conductor size	0.14 mm ²
Cable diameter	$\varnothing 3.4$ mm
Length of cable (L)	100 mm ¹⁾
Material	
Housing	Plastic, ABS
Front screen	Plastic, PMMA
Cable	Plastic, PVC
Weight	30 g

1) Do not bend below 0 °C.

Ambient data

Enclosure rating	IP67 IP66
Ambient operating temperature	-40 °C ... +60 °C
Ambient temperature, storage	-40 °C ... +75 °C

Classifications

ECLASS 5.0	27270902
ECLASS 5.1.4	27270902
ECLASS 6.0	27270902

ECLASS 6.2	27270902
ECLASS 7.0	27270902
ECLASS 8.0	27270902
ECLASS 8.1	27270902
ECLASS 9.0	27270902
ECLASS 10.0	27270902
ECLASS 11.0	27270902
ECLASS 12.0	27270902
ETIM 5.0	EC002717
ETIM 6.0	EC002717
ETIM 7.0	EC002717
ETIM 8.0	EC002717
UNSPSC 16.0901	39121528

Connection type

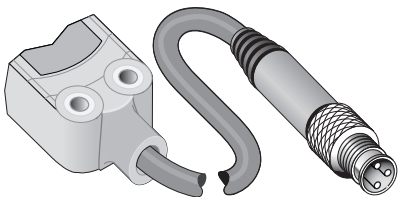

Connection diagram Cd-092

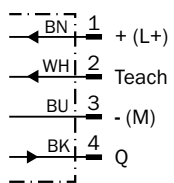

Modified teach mode

Geänderter Teach Modus modified teach mode WLG4-3

Bitte neuen Teach-In-Mode ab Herstellungswoche
01/2013 berücksichtigen.

Teach-In-Taste drücken:

- **2 Sek.** für transparente Objekte (8% Schaltschwelle mit autom. Nachführung)
- **8 Sek.** für Standardanwendungen (Schaltschwelle 50%)

Teach-In-Mode **vor** Herstellungswoche **01/2013**

Teach-In-Taste drücken:

- **2 Sek.** (50% Schaltschwelle ohne Nachführung)
 - **8 Sek.** für transparente Objekte (Schaltschwelle 10%)
-

Please consider new teach-in mode as of
production week **01/2013**.

Press teach-in button:

- **2 sec.** for clear objects (8% threshold with continuous threshold adaption)
- **8 sec.** for standard mode (50% threshold)

Teach-In-Mode **before** production week **01/2013**.

Press teach-in button:

- **2 sec.** (50% threshold without continuous threshold adaption)
 - **8 sec.** for clear objects (threshold 10%)
-

Bsp. Herstellungswoche 1309 = KW09/2013
eg production week 1309 = CW09/2013



SICK
Sensor Intelligence.

Dimensional drawing WLG4-3

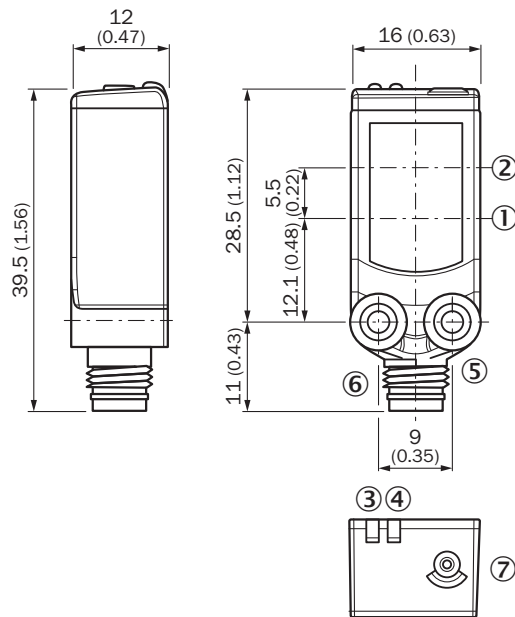







Dimensions in mm (inch)

- ① Center of optical axis, sender
- ② Center of optical axis, receiver
- ③ Orange LED indicator: status of received light beam
- ④ LED indicator green: Supply voltage active
- ⑤ Threaded mounting hole M3
- ⑥ Connection
- ⑦ Teach-in button

Recommended accessories

Other models and accessories → www.sick.com/W4

	Brief description	Type	part no.
Mounting systems			
	<ul style="list-style-type: none"> • Description: Universal mounting bracket for reflectors • Dimensions (W x H x L): 85 mm x 90 mm x 35 mm • Material: Steel • Details: Steel, zinc coated • Suitable for: C110A, P250, PL20, PL30A, PL40A, PL80A 	BEF-WN-REFX	2064574
	<ul style="list-style-type: none"> • Description: Plate N08 for universal clamp bracket • Material: Steel, zinc diecast • Details: Zinc plated steel (sheet), Zinc die cast (clamping bracket) • Items supplied: Universal clamp (5322626), mounting hardware • Usable for: W100, W150, W4S, W4F, W8, W9-3, W8G, W8 Laser, W8 Inox, G6, W100 Laser, W100-2, W10, G6 Inox, RAY10, W4SLG-3, W9, GR18, MultiPulse, Reflex Array, MultiLine, LUT3, KT5, KT8, KT10, CS8 	BEF-KHS-N08	2051607

	Brief description	Type	part no.
reflectors and optics			
	<ul style="list-style-type: none"> • Description: Fine triple reflector, screw connection, suitable for laser sensors • Dimensions: 52 mm 62 mm • Ambient operating temperature: -30 °C ... +65 °C 	P250F	5308843
connectors and cables			
	<ul style="list-style-type: none"> • Description: Unshielded • Connection type head A: Male connector, M8, 4-pin, straight, A-coded • Connection systems: Screw-type terminals • Permitted cross-section: 0.14 mm² ... 0.5 mm² 	STE-0804-G	6037323
	<ul style="list-style-type: none"> • Description: Sensor/actuator cable, unshielded • Connection type head A: Female connector, M8, 4-pin, straight, A-coded • Connection type head B: Flying leads • Signal type: Sensor/actuator cable • Cable: 5 m, 4-wire, PVC • Application: Uncontaminated zones, Zones with chemicals 	YF8U14-050VA3XLEAX	2095889
	<ul style="list-style-type: none"> • Description: Sensor/actuator cable, unshielded • Connection type head A: Female connector, M8, 4-pin, straight, A-coded • Connection type head B: Flying leads • Signal type: Sensor/actuator cable • Cable: 5 m, 4-wire, PUR, halogen-free • Application: Drag chain operation, Zones with oils and lubricants, Robot, Drag chain operation 	YF8U14-050UA3XLEAX	2094792

SICK AT A GLANCE

SICK is one of the leading manufacturers of intelligent sensors and sensor solutions for industrial applications. A unique range of products and services creates the perfect basis for controlling processes securely and efficiently, protecting individuals from accidents and preventing damage to the environment.

We have extensive experience in a wide range of industries and understand their processes and requirements. With intelligent sensors, we can deliver exactly what our customers need. In application centers in Europe, Asia and North America, system solutions are tested and optimized in accordance with customer specifications. All this makes us a reliable supplier and development partner.

Comprehensive services complete our offering: SICK LifeTime Services provide support throughout the machine life cycle and ensure safety and productivity.

For us, that is “Sensor Intelligence.”

WORLDWIDE PRESENCE:

Contacts and other locations –www.sick.com