



C40E-1203GK010

C4000 Palletizer

SAFETY LIGHT CURTAINS

SICK
Sensor Intelligence.



Illustration may differ

Ordering information

Type	part no.
C40E-1203GK010	1043221

Other models and accessories → www.sick.com/C4000_Palletizer



Detailed technical data

Features

Description	C4000 Palletizer Advanced with extension connection on receiver
Application	Normal industrial environment
System part	Receiver
Resolution	30 mm
Scanning range	7 m
Protective field height	1,200 mm
Synchronization	Optical synchronization
Items supplied	Receiver 8 sliding nuts for side mounting Test rod with diameter corresponding to the resolution of the safety light curtain Adhesive label with information on the daily check Operating instructions on CD-ROM CDS (Configuration & Diagnostic Software)

Safety-related parameters

Type	Type 4 (IEC 61496-1)
Safety integrity level	SIL 3 (IEC 61508)
Category	Category 4 (EN ISO 13849)
Performance level	PL e (EN ISO 13849)
PFH_D (mean probability of a dangerous failure per hour)	15×10^{-9}
T_M (mission time)	20 years (EN ISO 13849)
Safe state in the event of a fault	At least one OSSD is in the OFF state.

Functions

	Functions	Delivery status
Function range	Advanced	
Protective operation	✓	
Restart interlock	✓	Internal
External device monitoring (EDM)	✓	Deactivated

Beam coding	✓	Code 1
Configurable scanning range	✓	0.5 m ... 7 m
Reduced resolution	✓	2 beams
Self-teaching dynamic blanking for goods detection	✓	
Self-teaching dynamic blanking for pallet detection	✓	
Multiple sampling	✓	2x evaluation
Direction monitoring	✓	
Object entry monitoring	✓	
Emergency stop/bypass at the extension connection	✓	
Safe SICK device communication via EFI	✓	

Functions in combination with UE402

Bypass	✓
Operating mode switching	✓

Interfaces

System connection	
Direction of cable connection	Straight
Conductor cross section	0.75 mm ²
Permitted cable length	50 m ¹⁾
Extension connection	Hirschmann female connector M26, 12 pin
Configuration connection	Female connector M8, 4-pin
Configuration method	PC with CDS (Configuration and Diagnostic Software)
Display elements	7-segment display

¹⁾ Depending on load, power supply and wire cross-section. The technical specifications must be observed.

Electronics

Protection class	III (IEC 61140)
Supply voltage V_S	24 V DC (19.2 V ... 28.8 V) ¹⁾
Residual ripple	≤ 10 % ²⁾
Output signal switching devices (OSSDs)	
Type of output	2 PNP semiconductors, short-circuit protected, cross-circuit monitored ³⁾
ON state, switching voltage HIGH	24 V DC ($V_S - 2.25$ V DC ... V_S)
OFF state, switching voltage LOW	≤ 2 V DC
Current-carrying capacity per OSSD	≤ 500 mA
Application diagnostic output (ADO)	
Output voltage HIGH (active)	24 V DC (15 V DC ... 28.8 V DC)
Output voltage LOW (deactivated)	High resistance

¹⁾ The external voltage supply must be capable of buffering brief mains voltage failures of 20 ms as specified in EN 60204-1. Suitable power supplies are available as accessories from SICK.

²⁾ Within the limits of V_S .

³⁾ Applies to the voltage range between -30 V and +30 V.

Output current HIGH (active) ≤ 100 mA

¹⁾ The external voltage supply must be capable of buffering brief mains voltage failures of 20 ms as specified in EN 60204-1. Suitable power supplies are available as accessories from SICK.

²⁾ Within the limits of V_S .

³⁾ Applies to the voltage range between -30 V and +30 V.

Mechanics

Dimensions	See dimensional drawing
Housing cross-section	48 mm x 40 mm
Housing material	Aluminum extruded profile
Weight	2,560 g

Ambient data

Enclosure rating	IP65 (EN 60529)
Ambient operating temperature	0 °C ... +55 °C
Storage temperature	-25 °C ... +70 °C
Air humidity	15 % ... 95 %, Non-condensing
Vibration resistance	5 g, 10 Hz ... 55 Hz (EN 60068-2-6)
Shock resistance	10 g, 16 ms (EN 60068-2-27)

Other information

Wave length	850 nm
--------------------	--------

Certificates

EU declaration of conformity	✓
UK declaration of conformity	✓
ACMA declaration of conformity	✓
Moroccan declaration of conformity	✓
China RoHS	✓
ULus approval	✓
cUL approval	✓
EC-Type-Examination approval	✓
China GB certificate	✓
Information according to Art. 3 of Data Act (Regulation EU 2023/2854)	✓

Classifications

ECLASS 5.0	27272704
ECLASS 5.1.4	27272704
ECLASS 6.0	27272704
ECLASS 6.2	27272704
ECLASS 7.0	27272704
ECLASS 8.0	27272704
ECLASS 8.1	27272704
ECLASS 9.0	27272704
ECLASS 10.0	27272704

ECLASS 11.0	27272704
ECLASS 12.0	27272704
ETIM 5.0	EC002549
ETIM 6.0	EC002549
ETIM 7.0	EC002549
ETIM 8.0	EC002549
UNSPSC 16.0901	46171620

Dimensional drawing

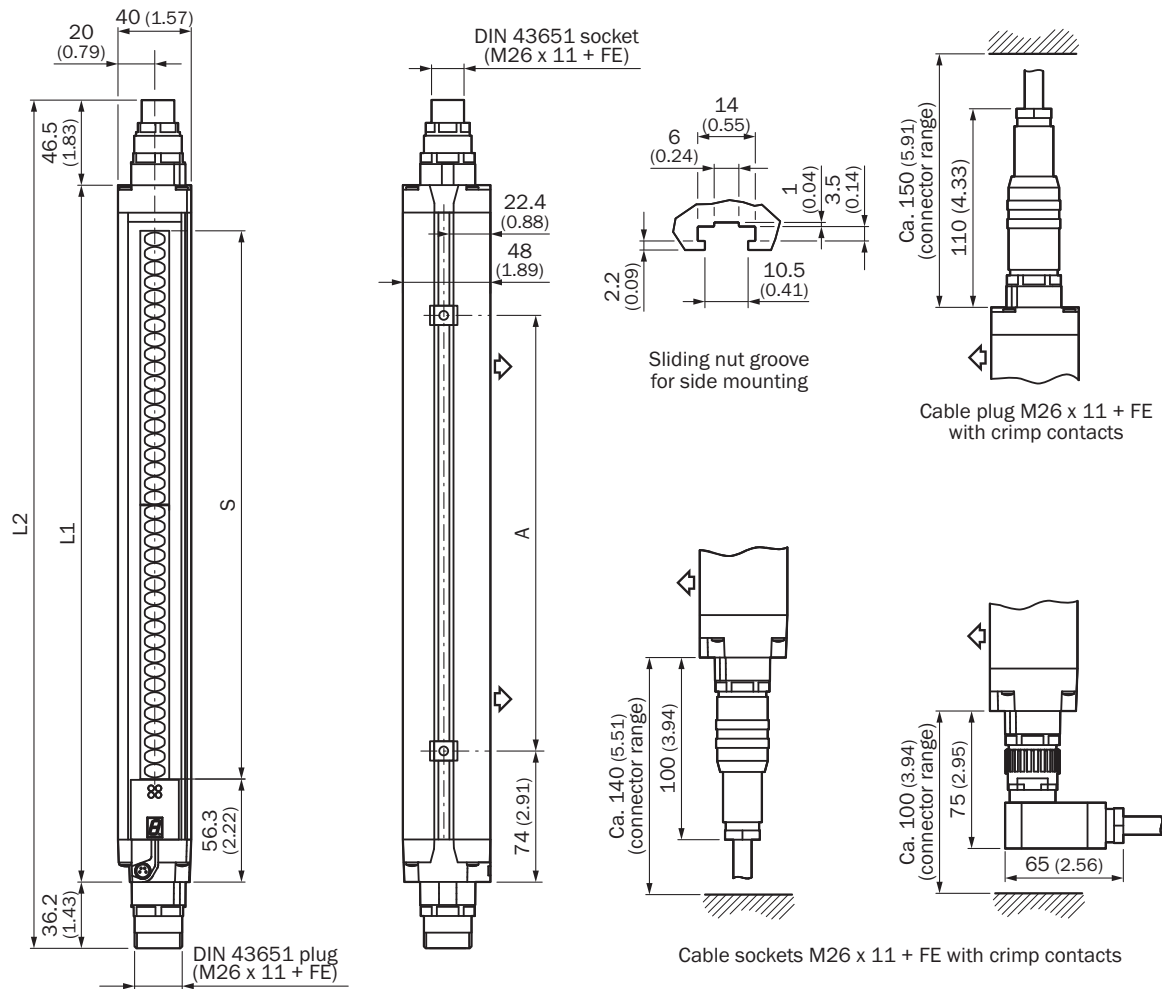

Dimensions in mm (inch)





illustration sender (receiver mirror image)





	L1	L2	A
300	381	464	224
450	532	614	374
600	682	765	524
750	833	915	674
900	984	1.066	824

	L1	L2	A
1.050	1.134	1.216	974
1.200	1.283	1.366	1.124
1.350	1.435	1.517	1.274
1.500	1.586	1.669	1.424
1.650	1.736	1.818	1.574
1.800	1.887	1.969	1.724



Recommended accessories

Other models and accessories → www.sick.com/C4000_Palletizer

	Brief description	Type	part no.
device protection and care			
	<ul style="list-style-type: none"> Product family: Cleaning agents Description: Cloth for cleaning optical surfaces 	Lens cloth	4003353
Mounting systems			
	<ul style="list-style-type: none"> Description: Mounting kit 6, side bracket, rotatable Material: Zinc diecast Details: Zinc diecast Packing unit: 4 pieces Suitable for: All protective field heights 	BEF-1SHABAZN4	2019506
	<ul style="list-style-type: none"> Description: Mounting kit 2, rotatable, swivel mount Material: Plastic Details: Polyamide PA6 Packing unit: 4 pieces Suitable for: All protective field heights 	BEF-2SMMEAKU4	2019659
	<ul style="list-style-type: none"> Description: Mounting kit 1, mounting bracket, rigid, L-shaped, including fixing screws and washers Packing unit: 4 pieces Suitable for: All protective field heights 	BEF-3WNGBAST4	7021352
	<ul style="list-style-type: none"> Description: Omega bracket, rotatable, fixable with only one screw, for mounting on the swivel mount Packing unit: 4 pieces Suitable for: All protective field heights in large housing 	BEF-2SMMEAAL4	2044847

	Brief description	Type	part no.
Commissioning aids and test equipment			
	<ul style="list-style-type: none"> Product: Alignment aids Dimensions (W x H x L): 19 mm 67.3 mm 66.9 mm Description: Laser alignment aid for various sensors, laser class 2 (IEC 60825). Do not look into the beam! 	AR60	1015741
	<ul style="list-style-type: none"> Product: Alignment aids Description: Adapter AR60 for housing cross-section 48 mm x 40 mm 	AR60 adapter, 48x40	4032461
	<ul style="list-style-type: none"> Product: Alignment aids Description: Adapter AR60 for housing cross-section 48 mm x 40 mm in PU3H device column 	AR60 adapter, 48x40, PU3H	4056731
	<ul style="list-style-type: none"> Product: Test equipment Description: 30 mm diameter, 250 mm length 	Test rod 30 mm	2022602

	Brief description	Type	part no.
connectors and cables			
	<ul style="list-style-type: none"> Description: Unshielded Connection type head A: Male connector, M26, 12-pin, angled, A-coded Connection systems: Crimp contacts Permitted cross-section: 0.5 mm² ... 1.5 mm² Note: 12 crimping contacts enclosed 	STE-0612W000GA3KMC	6021192
	<ul style="list-style-type: none"> Description: Unshielded Connection type head A: Male connector, M26, 12-pin, straight, A-coded Connection systems: Crimp contacts Permitted cross-section: 0.5 mm² ... 1.5 mm² Note: 12 crimping contacts enclosed 	STE-0612G000GA3KMC	6021191
	<ul style="list-style-type: none"> Description: Unshielded Connection type head A: Female connector, M26, 12-pin, straight, A-coded Connection systems: Crimp contacts Permitted cross-section: 0.5 mm² ... 1.5 mm² Note: 12 crimping contacts enclosed 	DOS-0612G000GA3KMC	6020757
	<ul style="list-style-type: none"> Description: Unshielded Connection type head A: Female connector, M26, 12-pin, angled, A-coded Connection systems: Crimp contacts Permitted cross-section: 0.5 mm² ... 1.5 mm² Note: 12 crimping contacts enclosed 	DOS-0612W000GA3KMC	6020758
	<ul style="list-style-type: none"> Connection type head A: Male connector, M8, 4-pin, straight Connection type head B: Male connector, USB-A, straight Cable: 2 m, 4-wire, PVC Description: Unshielded 	DSL-8U04G02M025KM:	6034574
	<ul style="list-style-type: none"> Connection type head A: Male connector, M8, 4-pin, straight Connection type head B: Male connector, USB-A, straight Cable: 10 m, 4-wire, PVC Description: Unshielded 	DSL-8U04G10M025KM:	6034575
	<ul style="list-style-type: none"> Connection type head A: Female connector, M26, 12-pin, straight Connection type head B: Flying leads Signal type: Sensor/actuator cable Cable: 20 m, 12-wire, PVC Description: Sensor/actuator cable, unshielded Connection systems: Flying leads Application: Uncontaminated zones, Zones with chemicals 	DOL-0612G20M075KMC	2022549
	<ul style="list-style-type: none"> Connection type head A: Female connector, M26, 12-pin, straight Connection type head B: Flying leads Signal type: Sensor/actuator cable Cable: 15 m, 12-wire, PVC Description: Sensor/actuator cable, unshielded Connection systems: Flying leads Application: Uncontaminated zones, Zones with chemicals 	DOL-0612G15M075KMC	2022548
	<ul style="list-style-type: none"> Connection type head A: Female connector, M26, 12-pin, straight Connection type head B: Flying leads Signal type: Sensor/actuator cable Cable: 10 m, 12-wire, PVC Description: Sensor/actuator cable, unshielded Connection systems: Flying leads Application: Uncontaminated zones, Zones with chemicals 	DOL-0612G10M075KMC	2022547
	<ul style="list-style-type: none"> Connection type head A: Female connector, M26, 12-pin, straight Connection type head B: Flying leads Cable: 5 m, PVC Description: Unshielded Connection systems: Flying leads Note: Without EFI: Pin 9 and 10 not connected Application: Uncontaminated zones, Zones with chemicals 	DOL-0610G05M075KMC	2046888
	<ul style="list-style-type: none"> Connection type head A: Female connector, M26, 12-pin, straight Connection type head B: Flying leads Cable: 10 m, PVC Description: Unshielded Connection systems: Flying leads Note: Without EFI: Pin 9 and 10 not connected 	DOL-0610G10M075KMC	2046889

	Brief description	Type	part no.
	<ul style="list-style-type: none"> • Application: Uncontaminated zones, Zones with chemicals • Connection type head A: Female connector, M26, 12-pin, straight • Connection type head B: Flying leads • Signal type: Sensor/actuator cable • Cable: 5 m, 12-wire, PVC • Description: Sensor/actuator cable, unshielded • Connection systems: Flying leads • Application: Uncontaminated zones, Zones with chemicals 	DOL-0612G05M075KM0	2022545
system plugs and extension modules			
	<ul style="list-style-type: none"> • Applications: Functionality upgrade • Description: Upgrades the C4000 Standard, Advanced, Palletizer, Entry/Exit, and Fusion to include the functions defined in the technical specifications, e.g., bypass, operating mode switching, and PSDI in the case of C4000 Standard, Advanced. • Compatible sensor types: C4000 safety light curtains 	UE402	1023577

SICK AT A GLANCE

SICK is one of the leading manufacturers of intelligent sensors and sensor solutions for industrial applications. A unique range of products and services creates the perfect basis for controlling processes securely and efficiently, protecting individuals from accidents and preventing damage to the environment.

We have extensive experience in a wide range of industries and understand their processes and requirements. With intelligent sensors, we can deliver exactly what our customers need. In application centers in Europe, Asia and North America, system solutions are tested and optimized in accordance with customer specifications. All this makes us a reliable supplier and development partner.

Comprehensive services complete our offering: SICK LifeTime Services provide support throughout the machine life cycle and ensure safety and productivity.

For us, that is “Sensor Intelligence.”

WORLDWIDE PRESENCE:

Contacts and other locations –www.sick.com