



WTB12-3N2411

W12

PHOTOELECTRIC SENSORS

SICK
Sensor Intelligence.



Illustration may differ

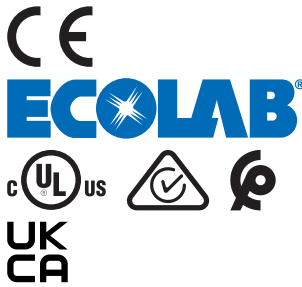

Ordering information

Type	part no.
WTB12-3N2411	1041427

Included in delivery: BEF-KH-W12 (1)

Other models and accessories → www.sick.com/W12

Detailed technical data

Features

Functional principle	Photoelectric proximity sensor
Functional principle detail	Background suppression
Sensing range max.	20 mm ... 600 mm ¹⁾
Sensing range	20 mm ... 600 mm
Emitted beam	
Light source	LED ²⁾
Type of light	Infrared light
Light spot size (distance)	15 mm x 15 mm (200 mm)
Key LED figures	
Wave length	850 nm
Adjustment	Potentiometer, 5 turns
Items supplied	2 x clamps BEF-KH-W12, incl. screws

¹⁾ Object with 90% remission (based on standard white, DIN 5033).

²⁾ Average service life: 100,000 h at T_J = +25 °C.

Safety-related parameters

MTTF_D	533 years
DC_{avg}	0 %
T_M (mission time)	20 years

Electronics

Supply voltage U_B	10 V DC ... 30 V DC ¹⁾
Ripple	< 5 V _{pp} ²⁾
Current consumption	55 mA ³⁾
Protection class	III
Digital output	
Type	NPN
Switching mode	Light/dark switching
Signal voltage NPN HIGH/LOW	Approx. V_S / < 2.5 V
Output current I_{max}	≤ 100 mA
Response time	≤ 330 μs ⁴⁾
Switching frequency	1,500 Hz ⁵⁾
Output function	Complementary
Circuit protection	A ⁶⁾ C ⁷⁾ D ⁸⁾

¹⁾ Limit values when operated in short-circuit protected network: max. 8 A.

²⁾ May not fall below or exceed U_V tolerances.

³⁾ Without load.

⁴⁾ Signal transit time with resistive load.

⁵⁾ With light/dark ratio 1:1.

⁶⁾ A = V_S connections reverse-polarity protected.

⁷⁾ C = interference suppression.

⁸⁾ D = outputs overcurrent and short-circuit protected.

Mechanics

Housing	Rectangular
Dimensions (W x H x D)	15.6 mm x 48.5 mm x 42 mm
Connection	Male connector M12, 4-pin
Material	
Housing	Metal
Front screen	Plastic, PMMA
Weight	120 g

Ambient data

Enclosure rating	IP66 IP67 IP69K
Ambient operating temperature	-40 °C ... +60 °C
Ambient temperature, storage	-40 °C ... +75 °C
UL File No.	NRKH.E181493 & NRKH7.E181493

Certificates

EU declaration of conformity	✓
UK declaration of conformity	✓
ACMA declaration of conformity	✓

Moroccan declaration of conformity	✓
China RoHS	✓
ECOLAB certificate	✓
cULus certificate	✓
Photobiological safety (DIN EN 62471) certificate	✓

Classifications

ECLASS 5.0	27270904
ECLASS 5.1.4	27270904
ECLASS 6.0	27270904
ECLASS 6.2	27270904
ECLASS 7.0	27270904
ECLASS 8.0	27270904
ECLASS 8.1	27270904
ECLASS 9.0	27270904
ECLASS 10.0	27270904
ECLASS 11.0	27270904
ECLASS 12.0	27270903
ETIM 5.0	EC002719
ETIM 6.0	EC002719
ETIM 7.0	EC002719
ETIM 8.0	EC002719
UNSPSC 16.0901	39121528

Dimensional drawing WTB12-3, potentiometer

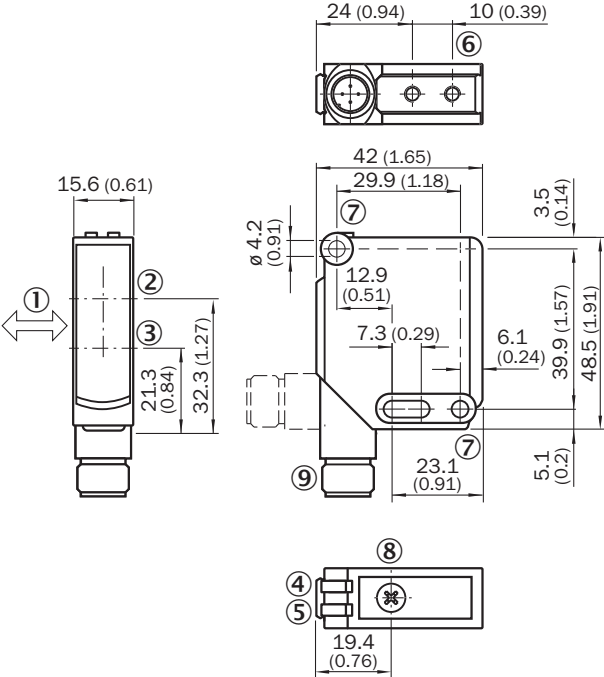

- Dimensions in mm (inch)
- ① Standard direction of the material being detected
 - ② Optical axis, receiver
 - ③ Optical axis, sender
 - ④ LED indicator green: Supply voltage active
 - ⑤ LED indicator yellow: Status of received light beam
 - ⑥ M4 threaded mounting hole, 4 mm deep
 - ⑦ Mounting hole, Ø 4.2 mm
 - ⑧ Sensing range adjustment: potentiometer
 - ⑨ Connection

Adjustments WTB12-3, WTF12-3, potentiometer

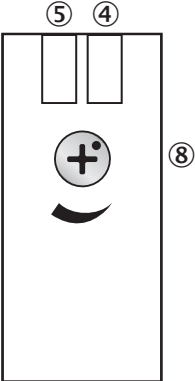

- ④ LED indicator green: Supply voltage active
- ⑤ LED indicator yellow: Status of received light beam
- ⑧ Sensing range adjustment: potentiometer

Connection type

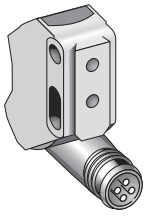

Connection diagram Cd-083

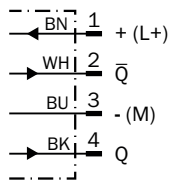

Characteristic curve WTB12-3, infrared light

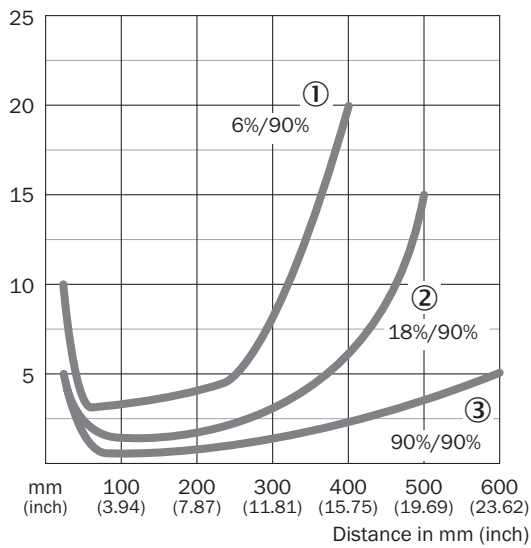

- ① Sensing range on black, 6% remission factor
- ② Sensing range on gray, 18% remission factor
- ③ Sensing range on white, 90% remission factor

Sensing range diagram WTB12-3, infrared light

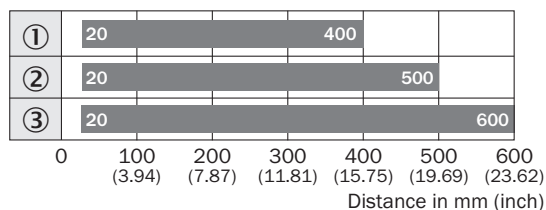





■ Sensing range

- ① Sensing range on black, 6% remission factor
- ② Sensing range on gray, 18% remission factor
- ③ Sensing range on white, 90% remission factor

Recommended accessories

Other models and accessories → www.sick.com/W12

	Brief description	Type	part no.
Mounting systems			
	<ul style="list-style-type: none"> • Description: Mounting bracket, large • Material: Stainless steel • Details: Stainless steel • Items supplied: Mounting hardware included • Suitable for: W11-2, W12-3, W16 	BEF-WG-W12	2013942
	<ul style="list-style-type: none"> • Description: Plate N11N for universal clamp bracket • Material: Stainless steel • Details: Stainless steel 1.4571 (sheet), Stainless steel 1.4408 (clamp) • Items supplied: Universal clamp (5322627), mounting hardware • Usable for: DeltaPac, Glare, WTD20E 	BEF-KHS-N11N	2071081
connectors and cables			
	<ul style="list-style-type: none"> • Connection type head A: Female connector, M12, 4-pin, straight, A-coded • Connection type head B: Flying leads • Signal type: Sensor/actuator cable • Cable: 5 m, 4-wire, PVC • Description: Sensor/actuator cable, unshielded • Application: Zones with chemicals, Uncontaminated zones 	YF2A14-050VB3XLEAX	2096235
	<ul style="list-style-type: none"> • Connection type head A: Female connector, M12, 4-pin, straight, A-coded • Connection type head B: Flying leads • Signal type: Sensor/actuator cable • Cable: 5 m, 4-wire, PUR, halogen-free • Description: Sensor/actuator cable, unshielded • Application: Uncontaminated zones, Zones with oils and lubricants, Robot, Drag chain operation 	YF2A14-050UB3XLEAX	2095608
	<ul style="list-style-type: none"> • Connection type head A: Male connector, M12, 4-pin, straight, A-coded • Description: Unshielded • Connection systems: Screw-type terminals • Permitted cross-section: ≤ 0.75 mm² 	STE-1204-G	6009932

SICK AT A GLANCE

SICK is one of the leading manufacturers of intelligent sensors and sensor solutions for industrial applications. A unique range of products and services creates the perfect basis for controlling processes securely and efficiently, protecting individuals from accidents and preventing damage to the environment.

We have extensive experience in a wide range of industries and understand their processes and requirements. With intelligent sensors, we can deliver exactly what our customers need. In application centers in Europe, Asia and North America, system solutions are tested and optimized in accordance with customer specifications. All this makes us a reliable supplier and development partner.

Comprehensive services complete our offering: SICK LifeTime Services provide support throughout the machine life cycle and ensure safety and productivity.

For us, that is “Sensor Intelligence.”

WORLDWIDE PRESENCE:

Contacts and other locations –www.sick.com