



# IME12-04BNOZCOS

IME

INDUCTIVE PROXIMITY SENSORS

**SICK**  
Sensor Intelligence.



### Ordering information

Type	part no.
IME12-04BNOZC0S	1040776

**Included in delivery:** BEF-MU-M12 (1)

Other models and accessories → [www.sick.com/IME](http://www.sick.com/IME)

Illustration may differ



### Detailed technical data

#### Features

<b>Housing</b>	Metric
<b>Housing</b>	Standard design
<b>Thread size</b>	M12 x 1
<b>Diameter</b>	Ø 12 mm
<b>Sensing range <math>S_n</math></b>	4 mm
<b>Safe sensing range <math>S_a</math></b>	3.24 mm
<b>Installation type</b>	Flush
<b>Switching frequency</b>	2,000 Hz
<b>Connection type</b>	Male connector M12, 4-pin
<b>Switching output</b>	NPN
<b>Switching output detail</b>	NPN
<b>Output function</b>	NC
<b>Electrical wiring</b>	DC 3-wire
<b>Enclosure rating</b>	IP67 <sup>1)</sup>
<b>Items supplied</b>	Mounting nut, brass, nickel-plated (2x)

<sup>1)</sup> According to EN 60529.

#### Mechanics/electronics

<b>Supply voltage</b>	10 V DC ... 30 V DC
<b>Ripple</b>	≤ 10 %
<b>Voltage drop</b>	≤ 2 V <sup>1)</sup>

<sup>1)</sup> At  $I_a$  max.

<sup>2)</sup> Supply voltage  $U_B$  and constant ambient temperature  $T_a$ .

<sup>3)</sup> Of  $S_r$ .

<b>Time delay before availability</b>	≤ 100 ms
<b>Hysteresis</b>	5 % ... 15 %
<b>Reproducibility</b>	≤ 2 % <sup>2)</sup> <sup>3)</sup>
<b>Temperature drift (of S<sub>r</sub>)</b>	± 10 %
<b>EMC</b>	According to EN 60947-5-2
<b>Continuous current I<sub>a</sub></b>	≤ 200 mA
<b>No load current</b>	≤ 10 mA
<b>Short-circuit protection</b>	✓
<b>Power-up pulse protection</b>	✓
<b>Shock and vibration resistance</b>	30 g, 11 ms/10 Hz ... 55 Hz, 1 mm
<b>Ambient operating temperature</b>	-25 °C ... +75 °C
<b>Housing material</b>	Brass, nickel-plated
<b>Sensing face material</b>	Plastic, PA 66
<b>Housing length</b>	65 mm
<b>Thread length</b>	48 mm
<b>Tightening torque, max.</b>	≤ 12 Nm
<b>UL File No.</b>	NRKH.E181493

<sup>1)</sup> At I<sub>a</sub> max.

<sup>2)</sup> Supply voltage U<sub>B</sub> and constant ambient temperature T<sub>a</sub>.

<sup>3)</sup> Of S<sub>r</sub>.

### Safety-related parameters

<b>MTTF<sub>D</sub></b>	1,735 years
<b>DC<sub>avg</sub></b>	0 %

### Reduction factors

<b>Note</b>	The values are reference values which may vary
<b>St37 steel (Fe)</b>	1
<b>Stainless steel (V2A, 304)</b>	Approx. 0.8
<b>Aluminum (Al)</b>	Approx. 0.45
<b>Copper (Cu)</b>	Approx. 0.4
<b>Brass (Br)</b>	Approx. 0.4

### Installation note

<b>Remark</b>	Associated graphic see "Installation"
<b>B</b>	24 mm
<b>C</b>	12 mm
<b>D</b>	12 mm
<b>F</b>	32 mm

### Certificates

<b>EU declaration of conformity</b>	✓
<b>UK declaration of conformity</b>	✓
<b>ACMA declaration of conformity</b>	✓

<b>Moroccan declaration of conformity</b>	✓
<b>China RoHS</b>	✓
<b>cULus certificate</b>	✓

Classifications

<b>ECLASS 5.0</b>	27270101
<b>ECLASS 5.1.4</b>	27270101
<b>ECLASS 6.0</b>	27270101
<b>ECLASS 6.2</b>	27270101
<b>ECLASS 7.0</b>	27270101
<b>ECLASS 8.0</b>	27270101
<b>ECLASS 8.1</b>	27270101
<b>ECLASS 9.0</b>	27270101
<b>ECLASS 10.0</b>	27270101
<b>ECLASS 11.0</b>	27270101
<b>ECLASS 12.0</b>	27274001
<b>ETIM 5.0</b>	EC002714
<b>ETIM 6.0</b>	EC002714
<b>ETIM 7.0</b>	EC002714
<b>ETIM 8.0</b>	EC002714
<b>UNSPSC 16.0901</b>	39122230

Installation note Flush installation

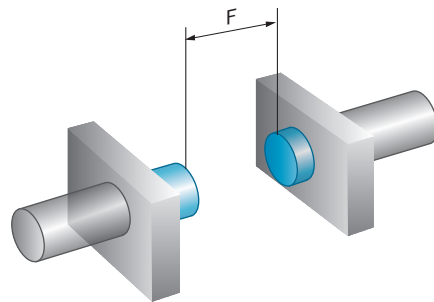
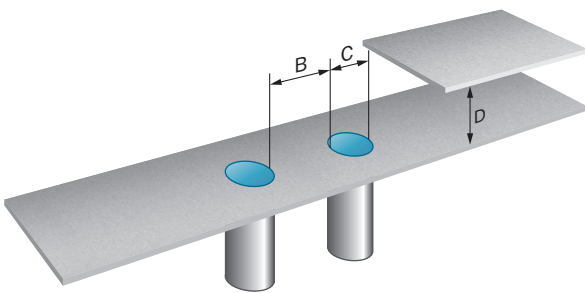

Connection type

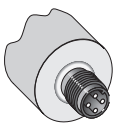

### Connection diagram Cd-008



### Dimensional drawing IME12 Standard, connector, flush

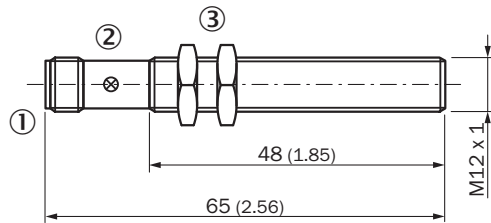





Dimensions in mm (inch)

- ① Connection
- ② Display LED
- ③ Fastening nuts (2x); width across 17, metal

### Recommended accessories

Other models and accessories → [www.sick.com/IME](http://www.sick.com/IME)

	Brief description	Type	part no.
<b>Mounting systems</b>			
	<ul style="list-style-type: none"> <li><b>Description:</b> Clamping block for round sensors M12, with fixed stop</li> <li><b>Material:</b> Plastic</li> <li><b>Details:</b> Plastic (PA12), glass-fiber reinforced</li> <li><b>Items supplied:</b> Mounting hardware included</li> </ul>	BEF-KHF-M12	2051480
	<ul style="list-style-type: none"> <li><b>Description:</b> Mounting plate for M12 sensors</li> <li><b>Material:</b> Steel</li> <li><b>Details:</b> Steel, zinc coated</li> <li><b>Items supplied:</b> Without mounting hardware</li> </ul>	BEF-WG-M12	5321869
	<ul style="list-style-type: none"> <li><b>Description:</b> Mounting bracket for M12 sensors</li> <li><b>Material:</b> Steel</li> <li><b>Details:</b> Steel, zinc coated</li> <li><b>Items supplied:</b> Without mounting hardware</li> </ul>	BEF-WN-M12	5308447
	<ul style="list-style-type: none"> <li><b>Description:</b> Clamping block for round sensors M12, without fixed stop</li> <li><b>Material:</b> Plastic</li> <li><b>Details:</b> Plastic (PA12), glass-fiber reinforced</li> <li><b>Items supplied:</b> Mounting hardware included</li> </ul>	BEF-KH-M12	2051479

	Brief description	Type	part no.
connectors and cables			
	<ul style="list-style-type: none"> <li><b>Description:</b> Unshielded</li> <li><b>Connection type head A:</b> Female connector, M12, 4-pin, straight, A-coded</li> <li><b>Connection systems:</b> Screw-type terminals</li> <li><b>Permitted cross-section:</b> ≤ 0.75 mm<sup>2</sup></li> </ul>	DOS-1204-G	6007302
	<ul style="list-style-type: none"> <li><b>Description:</b> Unshielded</li> <li><b>Connection type head A:</b> Female connector, M12, 4-pin, angled, A-coded</li> <li><b>Connection systems:</b> Screw-type terminals</li> <li><b>Permitted cross-section:</b> ≤ 0.75 mm<sup>2</sup></li> </ul>	DOS-1204-W	6007303
	<ul style="list-style-type: none"> <li><b>Description:</b> Sensor/actuator cable, unshielded</li> <li><b>Connection type head A:</b> Female connector, M12, 4-pin, straight</li> <li><b>Connection type head B:</b> Flying leads</li> <li><b>Signal type:</b> Sensor/actuator cable</li> <li><b>Cable:</b> 5 m, 4-wire, PVC</li> <li><b>Connection systems:</b> Flying leads</li> <li><b>Note:</b> This product is generally resistant to chemical cleaning agents (see ECOLAB). Please do not use cleaning agents of any other Kind., Not resistant against lactic acid &amp; hydrogen peroxide (H2O2)</li> <li><b>Application:</b> Uncontaminated zones, Hygienic and washdown zones, Zones with chemicals</li> </ul>	YF2AP4-050VB3XLEAX	6052615
	<ul style="list-style-type: none"> <li><b>Description:</b> Sensor/actuator cable, unshielded</li> <li><b>Connection type head A:</b> Female connector, M12, 4-pin, straight</li> <li><b>Connection type head B:</b> Flying leads</li> <li><b>Signal type:</b> Sensor/actuator cable</li> <li><b>Cable:</b> 5 m, 4-wire, PP</li> <li><b>Connection systems:</b> Flying leads</li> <li><b>Note:</b> This product is generally resistant to chemical cleaning agents (see ECOLAB) and other chemical compounds such as H2O2 and CH2O2. Before permanent installation is carried out, the material's resistance to the cleaning agent being used must be checked., Resistant against lactic acid &amp; hydrogen peroxide (H2O2)</li> <li><b>Application:</b> Hygienic and washdown zones, Drag chain operation, Robot, cold bending resistant, seawater resistant</li> </ul>	DOL-1204-G05MRN	6058476
	<ul style="list-style-type: none"> <li><b>Description:</b> Sensor/actuator cable, unshielded</li> <li><b>Connection type head A:</b> Female connector, M12, 4-pin, straight, A-coded</li> <li><b>Connection type head B:</b> Flying leads</li> <li><b>Signal type:</b> Sensor/actuator cable</li> <li><b>Cable:</b> 5 m, 4-wire, PVC</li> <li><b>Application:</b> Uncontaminated zones, Zones with chemicals</li> </ul>	YF2A14-050VB3XLEAX	2096235
	<ul style="list-style-type: none"> <li><b>Description:</b> Sensor/actuator cable, unshielded</li> <li><b>Connection type head A:</b> Female connector, M12, 4-pin, straight, A-coded</li> <li><b>Connection type head B:</b> Flying leads</li> <li><b>Signal type:</b> Sensor/actuator cable</li> <li><b>Cable:</b> 5 m, 4-wire, PUR, halogen-free</li> <li><b>Application:</b> Drag chain operation, Zones with oils and lubricants, Robot, Drag chain operation</li> </ul>	YF2A14-050UB3XLEAX	2095608
	<ul style="list-style-type: none"> <li><b>Description:</b> Sensor/actuator cable, unshielded</li> <li><b>Connection type head A:</b> Female connector, M12, 4-pin, angled, A-coded</li> <li><b>Connection type head B:</b> Flying leads</li> <li><b>Signal type:</b> Sensor/actuator cable</li> <li><b>Cable:</b> 0.6 m, 4-wire, PVC</li> <li><b>Application:</b> Uncontaminated zones, Zones with chemicals</li> </ul>	YG2A14-C60VB3XLEAX	2145709
	<ul style="list-style-type: none"> <li><b>Description:</b> Sensor/actuator cable, unshielded</li> <li><b>Connection type head A:</b> Female connector, M12, 4-pin, angled, A-coded</li> <li><b>Connection type head B:</b> Flying leads</li> <li><b>Signal type:</b> Sensor/actuator cable</li> <li><b>Cable:</b> 1 m, 4-wire, PVC</li> <li><b>Application:</b> Uncontaminated zones, Zones with chemicals</li> </ul>	YG2A14-010VB3XLEAX	2145710
	<ul style="list-style-type: none"> <li><b>Description:</b> Sensor/actuator cable, unshielded</li> <li><b>Connection type head A:</b> Female connector, M12, 4-pin, straight, A-coded</li> <li><b>Connection type head B:</b> Flying leads</li> <li><b>Signal type:</b> Sensor/actuator cable</li> <li><b>Cable:</b> 0.6 m, 4-wire, PVC</li> <li><b>Application:</b> Uncontaminated zones, Zones with chemicals</li> </ul>	YF2A14-C60VB3XLEAX	2145707
	<ul style="list-style-type: none"> <li><b>Description:</b> Sensor/actuator cable, unshielded</li> <li><b>Connection type head A:</b> Female connector, M12, 4-pin, straight, A-coded</li> <li><b>Connection type head B:</b> Flying leads</li> <li><b>Signal type:</b> Sensor/actuator cable</li> <li><b>Cable:</b> 1 m, 4-wire, PVC</li> <li><b>Application:</b> Uncontaminated zones, Zones with chemicals</li> </ul>	YF2A14-010VB3XLEAX	2145708

## SICK AT A GLANCE

SICK is one of the leading manufacturers of intelligent sensors and sensor solutions for industrial applications. A unique range of products and services creates the perfect basis for controlling processes securely and efficiently, protecting individuals from accidents and preventing damage to the environment.

We have extensive experience in a wide range of industries and understand their processes and requirements. With intelligent sensors, we can deliver exactly what our customers need. In application centers in Europe, Asia and North America, system solutions are tested and optimized in accordance with customer specifications. All this makes us a reliable supplier and development partner.

Comprehensive services complete our offering: SICK LifeTime Services provide support throughout the machine life cycle and ensure safety and productivity.

For us, that is “Sensor Intelligence.”

## WORLDWIDE PRESENCE:

Contacts and other locations –[www.sick.com](http://www.sick.com)