



# KHK53-PXF00038

KH53

MAGNETIC LINEAR ENCODERS

**SICK**  
Sensor Intelligence.



### Ordering information

Type	part no.
KHK53-PXF00038	1036163

Other models and accessories → [www.sick.com/KH53](http://www.sick.com/KH53)

Illustration may differ



### Detailed technical data

#### Safety-related parameters

<b>MTTF<sub>D</sub> (mean time to dangerous failure)</b>	40 years (EN ISO 13849) <sup>1)</sup>
--	---------------------------------------

<sup>1)</sup> This product is a standard product and does not constitute a safety component as defined in the Machinery Directive. Calculation based on nominal load of components, average ambient temperature 40 °C, frequency of use 8760 h/a. All electronic failures are considered hazardous. For more information, see document no. 8015532.

#### Performance

<b>Measuring range</b>	0 m ... 38 m
<b>Resolution</b>	0.1 mm
<b>Traversing speed</b>	6.6 m/s <sup>1)</sup>
<b>Repeatability</b>	0.3 mm
<b>Measurement accuracy</b>	± 1000 + ME (Tu-25 °C) Tk μm <sup>2)</sup>

<sup>1)</sup> If the max. traversing speed is exceeded or if the measuring elements are left, the corresponding error message is triggered (with SSI: FF FF FE hex).

<sup>2)</sup> If a positional tolerance of ± 1 mm is observed relative to the nominal distance in the N and Y directions within a measuring element relative to the starting point of this element ME = length of measuring element Tu = ambient temperature in °C. Tk = coefficient of thermal expansion (28 μm/°C/m).

#### Interfaces

<b>Communication interface</b>	PROFIBUS DP <sup>1)</sup>
<b>Bus interface</b>	RS-485, according to EN 50 170-2 (DIN 19245 Parts 1-3) electrically isolated by optocoupler
<b>Position forming time</b>	+ 1.1 ms
<b>Address setting</b>	0 ... 127, Hex switches or Protocol
<b>Data protocol</b>	PROFIBUS DP basic functions (DP-V0)
<b>Bus termination</b>	Via external switches
<b>Set (electronic adjustment)</b>	Via protocol
<b>Encoder profile</b>	Profile for encoders (07hex) – Class 2
<b>Data transmission rate (baud rate)</b>	9.6 kBaud ... 12 MBaud, Automatic detection
<b>Status information</b>	Operation (green LED) Bus activity (red LED)

<sup>1)</sup> According to EN 50 170-2 (DIN 19245 Parts 1-3) electrically isolated by optocoupler.

## Electronics

<b>Initialization time</b>	2 s
<b>Supply voltage</b>	10 V ... 32 V
<b>Power consumption</b>	2.5 W
<b>Connection type</b>	Male connector, 3x, M12

## Mechanics

<b>Weight</b>	2.4 kg
<b>Length of measuring element</b>	See calculation example
<b>Position tolerance</b>	± 10 mm, see positional tolerances diagram
<b>Read head material</b>	AlMgSiPbF28

## Ambient data

<b>EMC</b>	According to EN 61000-6-2 and EN 61000-6-4 <sup>1)</sup>
<b>Enclosure rating</b>	IP67, with mating plug inserted (IEC 60529)
<b>Operating temperature range</b>	-20 °C ... +60 °C
<b>Storage temperature range</b>	-40 °C ... +85 °C
<b>Resistance to shocks</b>	30 g, 10 ms (DIN EN 60 068-2-27)
<b>Resistance to vibration</b>	10 g, 20 Hz ... 250 Hz (EN 60068-2-6)

<sup>1)</sup> EMC according to the standards quoted is achieved if shielded cables are used.

## Certificates

<b>EU declaration of conformity</b>	✓
<b>UK declaration of conformity</b>	✓
<b>ACMA declaration of conformity</b>	✓
<b>Moroccan declaration of conformity</b>	✓
<b>China RoHS</b>	✓
<b>Information according to Art. 3 of Data Act (Regulation EU 2023/2854)</b>	✓

## Classifications

<b>ECLASS 5.0</b>	27270705
<b>ECLASS 5.1.4</b>	27270705
<b>ECLASS 6.0</b>	27270705
<b>ECLASS 6.2</b>	27270705
<b>ECLASS 7.0</b>	27270705
<b>ECLASS 8.0</b>	27270705
<b>ECLASS 8.1</b>	27270705
<b>ECLASS 9.0</b>	27270705
<b>ECLASS 10.0</b>	27270705
<b>ECLASS 11.0</b>	27270705
<b>ECLASS 12.0</b>	27274304
<b>ETIM 5.0</b>	EC002544
<b>ETIM 6.0</b>	EC002544

<b>ETIM 7.0</b>	EC002544
<b>ETIM 8.0</b>	EC002544
<b>UNSPSC 16.0901</b>	411111613

### Dimensional drawing Read head PROFIBUS

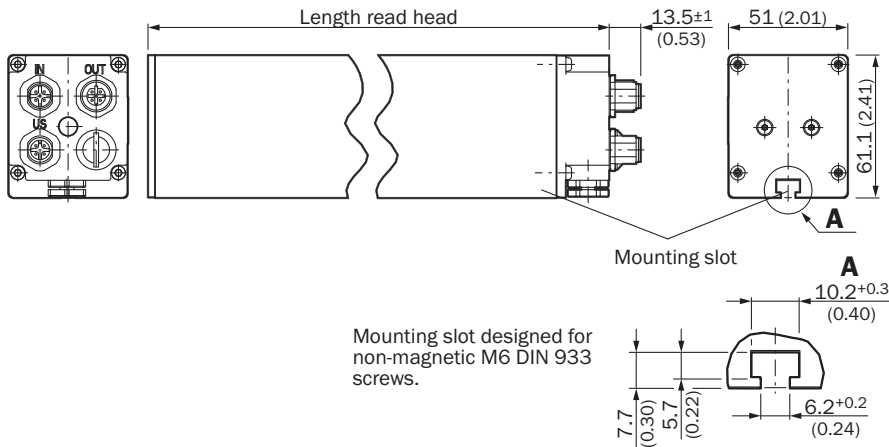

Dimensions in mm (inch)

### PIN assignment PROFIBUS interface

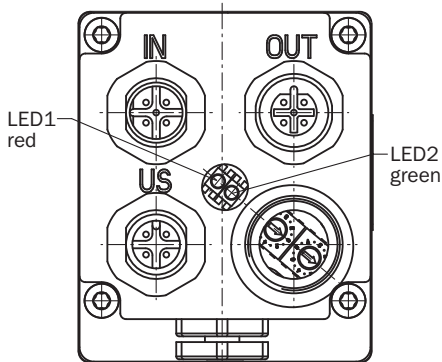

Male connector M12, 4-pin	Plug, M12, 5-pin	Female connector M12, 5-pin	Signal	Explanation
1	-	-	U <sub>S</sub>	Supply voltage
3	-	-	GND	Ground connection
-	-	4	B	B-cable PROFIBUS DP (out)
-	-	2	A	A-cable PROFIBUS DP (out)
-	4	-	B	B-cable PROFIBUS DP (in)
-	2	-	A	A-cable PROFIBUS DP (in)
-	-	1	2P5 <sup>1)</sup>	+ 5 V (potential free)
-	-	3	2M <sup>1)</sup>	0 V (potential free)
4	1	-	Not connected	-

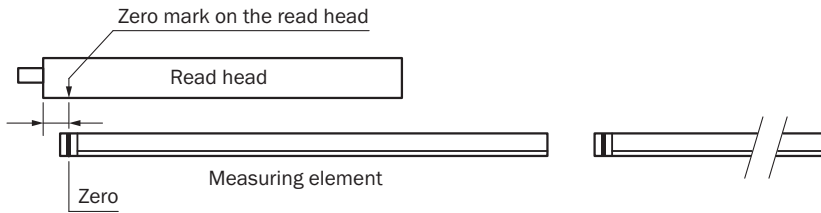

Male connector M12, 4-pin	Plug, M12, 5-pin	Female connector M12, 5-pin	Signal	Explanation
2	3	-	Not connected	-
-	5	5	Screen	Housing potential
1)Use for external bus termination				

**Position tolerance Start of measuring path**







**Recommended accessories**

Other models and accessories → [www.sick.com/KH53](http://www.sick.com/KH53)

	Brief description	Type	part no.
<b>Mounting systems</b>			
	<ul style="list-style-type: none"> <li><b>Description:</b> Mounting bracket for KH53 measuring elements</li> <li><b>Items supplied:</b> Without mounting hardware for the background</li> </ul>	BEF-WK-KHT53	2029159
	<ul style="list-style-type: none"> <li><b>Description:</b> Spacer for KHT53</li> <li><b>Items supplied:</b> Without mounting hardware for the background</li> </ul>	BEF-KHA-KHT53	2042468

	Brief description	Type	part no.
connectors and cables			
	<ul style="list-style-type: none"> <li><b>Description:</b> PROFIBUS DP, shielded</li> <li><b>Connection type head A:</b> Flying leads</li> <li><b>Connection type head B:</b> Flying leads</li> <li><b>Signal type:</b> PROFIBUS DP</li> <li><b>Items supplied:</b> By the meter</li> <li><b>Cable:</b> 2-wire, PUR</li> </ul>	LTG-2102-MW	6021355
	<ul style="list-style-type: none"> <li><b>Description:</b> Unshielded</li> <li><b>Connection type head A:</b> Female connector, M12, 4-pin, straight, A-coded</li> <li><b>Connection systems:</b> Screw-type terminals</li> <li><b>Permitted cross-section:</b> ≤ 0.75 mm<sup>2</sup></li> </ul>	DOS-1204-G	6007302
	<ul style="list-style-type: none"> <li><b>Description:</b> PROFIBUS DP, shielded</li> <li><b>Connection type head A:</b> Female connector, M12, 5-pin, straight, B-coded</li> <li><b>Signal type:</b> PROFIBUS DP</li> <li><b>Connection systems:</b> Screw-type terminals</li> <li><b>Permitted cross-section:</b> ≤ 0.75 mm<sup>2</sup></li> </ul>	DOS-1205-GQ	6021353
	<ul style="list-style-type: none"> <li><b>Description:</b> PROFIBUS DP, shielded</li> <li><b>Connection type head A:</b> Male connector, M12, 5-pin, straight, B-coded</li> <li><b>Signal type:</b> PROFIBUS DP</li> <li><b>Connection systems:</b> Screw-type terminals</li> <li><b>Permitted cross-section:</b> ≤ 0.75 mm<sup>2</sup></li> </ul>	STE-1205-GQ	6021354
	<ul style="list-style-type: none"> <li><b>Description:</b> PROFIBUS DP, terminal resistor</li> <li><b>Connection type head A:</b> Male connector, M12, 4-pin, straight, B-coded</li> <li><b>Signal type:</b> PROFIBUS DP</li> </ul>	STE-END-Q	6021156
	<ul style="list-style-type: none"> <li><b>Connection type head A:</b> Female connector, M12, 5-pin, straight, B-coded</li> <li><b>Connection type head B:</b> Flying leads</li> <li><b>Signal type:</b> Fieldbus, PROFIBUS DP</li> <li><b>Cable:</b> 30 m, 2-wire, PUR, halogen-free</li> <li><b>Description:</b> Fieldbus, twisted pair, shielded, PROFIBUS DP</li> <li><b>Connection systems:</b> Flying leads</li> <li><b>Application:</b> Zones with oils and lubricants</li> </ul>	DOL-1205-G30MQ	6032639
	<ul style="list-style-type: none"> <li><b>Connection type head A:</b> Female connector, M12, 5-pin, straight, B-coded</li> <li><b>Connection type head B:</b> Flying leads</li> <li><b>Signal type:</b> Fieldbus, PROFIBUS DP</li> <li><b>Cable:</b> 50 m, 2-wire, PUR, halogen-free</li> <li><b>Description:</b> Fieldbus, twisted pair, shielded, PROFIBUS DP</li> <li><b>Connection systems:</b> Flying leads</li> <li><b>Application:</b> Zones with oils and lubricants</li> </ul>	DOL-1205-G50MQ	6032861
	<ul style="list-style-type: none"> <li><b>Description:</b> Sensor/actuator cable, unshielded</li> <li><b>Connection type head A:</b> Female connector, M12, 4-pin, straight, A-coded</li> <li><b>Connection type head B:</b> Flying leads</li> <li><b>Signal type:</b> Sensor/actuator cable</li> <li><b>Cable:</b> 5 m, 4-wire, PVC</li> <li><b>Application:</b> Uncontaminated zones, Zones with chemicals</li> </ul>	YF2A14-050VB3XLEAX	2096235
	<ul style="list-style-type: none"> <li><b>Connection type head A:</b> Male connector, M12, 2-pin, straight, B-coded</li> <li><b>Connection type head B:</b> Flying leads</li> <li><b>Signal type:</b> Fieldbus, PROFIBUS DP</li> <li><b>Cable:</b> 15 m, 2-wire, PUR, halogen-free</li> <li><b>Description:</b> Fieldbus, shielded, PROFIBUS DP</li> <li><b>Application:</b> Drag chain operation, Zones with oils and lubricants</li> </ul>	YM2B22-150P-B1XLEAX	2106276
	<ul style="list-style-type: none"> <li><b>Connection type head A:</b> Male connector, M12, 2-pin, straight, B-coded</li> <li><b>Connection type head B:</b> Flying leads</li> <li><b>Signal type:</b> Fieldbus, PROFIBUS DP</li> <li><b>Cable:</b> 5 m, 2-wire, PUR, halogen-free</li> <li><b>Description:</b> Fieldbus, shielded, PROFIBUS DP</li> <li><b>Application:</b> Drag chain operation, Zones with oils and lubricants</li> </ul>	YM2B22-050P-B1XLEAX	2106270
	<ul style="list-style-type: none"> <li><b>Connection type head A:</b> Male connector, M12, 2-pin, straight, B-coded</li> <li><b>Connection type head B:</b> Flying leads</li> <li><b>Signal type:</b> Fieldbus, PROFIBUS DP</li> <li><b>Cable:</b> 10 m, 2-wire, PUR, halogen-free</li> <li><b>Description:</b> Fieldbus, shielded, PROFIBUS DP</li> </ul>	YM2B22-100P-B1XLEAX	2106271

	Brief description	Type	part no.
	<ul style="list-style-type: none"> <li><b>Application:</b> Drag chain operation, Zones with oils and lubricants</li> <li><b>Connection type head A:</b> Female connector, M12, 2-pin, straight, B-coded</li> <li><b>Connection type head B:</b> Flying leads</li> <li><b>Signal type:</b> Fieldbus, PROFIBUS DP</li> <li><b>Cable:</b> 10 m, 2-wire, PUR, halogen-free</li> <li><b>Description:</b> Fieldbus, shielded, PROFIBUS DP</li> <li><b>Application:</b> Drag chain operation, Zones with oils and lubricants</li> </ul>	YF2B22-100P-B1XLEAX	2106269
	<ul style="list-style-type: none"> <li><b>Connection type head A:</b> Female connector, M12, 2-pin, straight, B-coded</li> <li><b>Connection type head B:</b> Flying leads</li> <li><b>Signal type:</b> Fieldbus, PROFIBUS DP</li> <li><b>Cable:</b> 15 m, 2-wire, PUR, halogen-free</li> <li><b>Description:</b> Fieldbus, shielded, PROFIBUS DP</li> <li><b>Application:</b> Drag chain operation, Zones with oils and lubricants</li> </ul>	YF2B22-150P-B1XLEAX	2106272
	<ul style="list-style-type: none"> <li><b>Connection type head A:</b> Female connector, M12, 2-pin, straight, B-coded</li> <li><b>Connection type head B:</b> Flying leads</li> <li><b>Signal type:</b> Fieldbus, PROFIBUS DP</li> <li><b>Cable:</b> 20 m, 2-wire, PUR, halogen-free</li> <li><b>Description:</b> Fieldbus, shielded, PROFIBUS DP</li> <li><b>Application:</b> Drag chain operation, Zones with oils and lubricants</li> </ul>	YF2B22-200P-B1XLEAX	2106273
	<ul style="list-style-type: none"> <li><b>Connection type head A:</b> Female connector, M12, 2-pin, straight, B-coded</li> <li><b>Connection type head B:</b> Flying leads</li> <li><b>Signal type:</b> Fieldbus, PROFIBUS DP</li> <li><b>Cable:</b> 5 m, 2-wire, PUR, halogen-free</li> <li><b>Description:</b> Fieldbus, shielded, PROFIBUS DP</li> <li><b>Application:</b> Drag chain operation, Zones with oils and lubricants</li> </ul>	YF2B22-050P-B1XLEAX	2121936
<b>Linear encoders</b>			
	<ul style="list-style-type: none"> <li><b>System part:</b> Measuring element</li> <li><b>Measuring range:</b> 0 m ... 38 m</li> <li><b>Code type:</b> Coded</li> </ul>	KHT53-XXX00038	1030055
	<ul style="list-style-type: none"> <li><b>System part:</b> Measuring element</li> <li><b>Measuring range:</b> 0 m ... 38 m</li> <li><b>Code type:</b> Universal configurable</li> </ul>	KHU53-XXX00038	1030056
	<ul style="list-style-type: none"> <li><b>System part:</b> Mounting gauge</li> <li><b>Measuring range:</b> 0 m ... 38 m</li> </ul>	KHM53-XXX00038	1030057

## SICK AT A GLANCE

SICK is one of the leading manufacturers of intelligent sensors and sensor solutions for industrial applications. A unique range of products and services creates the perfect basis for controlling processes securely and efficiently, protecting individuals from accidents and preventing damage to the environment.

We have extensive experience in a wide range of industries and understand their processes and requirements. With intelligent sensors, we can deliver exactly what our customers need. In application centers in Europe, Asia and North America, system solutions are tested and optimized in accordance with customer specifications. All this makes us a reliable supplier and development partner.

Comprehensive services complete our offering: SICK LifeTime Services provide support throughout the machine life cycle and ensure safety and productivity.

For us, that is “Sensor Intelligence.”

## WORLDWIDE PRESENCE:

Contacts and other locations –[www.sick.com](http://www.sick.com)