

ARS60-A1A03600

ARS60

ABSOLUTE ENCODERS

SICK
Sensor Intelligence.

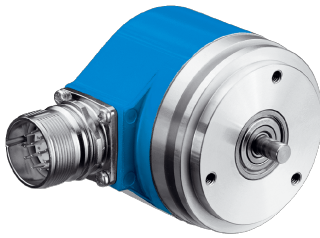

Ordering information

| Type | part no. |
|----------------|----------|
| ARS60-A1A03600 | 1035830 |

Other models and accessories → www.sick.com/ARS60

Illustration may differ

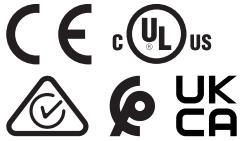

Detailed technical data

Safety-related parameters

| | |
|--|--|
| MTTF_D (mean time to dangerous failure) | 300 years (EN ISO 13849-1) ¹⁾ |
|--|--|

¹⁾ This product is a standard product and does not constitute a safety component as defined in the Machinery Directive. Calculation based on nominal load of components, average ambient temperature 40 °C, frequency of use 8760 h/a. All electronic failures are considered hazardous. For more information, see document no. 8015532.

Performance

| | |
|---|---|
| Number of steps per revolution (max. resolution) | 3,600 |
| Measuring step | 360° / number of steps |
| Measuring step deviation | 0.016° non-binary number of steps |
| Error limits G | 0.046° (non-binary number of steps) ¹⁾ |
| Repeatability standard deviation σ_r | 0.005° ²⁾ |

¹⁾ In accordance with DIN ISO 1319-1, position of the upper and lower error limit depends on the installation situation, specified value refers to a symmetrical position, i.e. deviation in upper and lower direction is the same.

²⁾ In accordance with DIN ISO 55350-13; 68.3% of the measured values are inside the specified area.

Interfaces

| | |
|---|---|
| Communication interface | SSI |
| Initialization time | 80 ms ¹⁾ |
| Code type | Gray |
| Code sequence parameter adjustable | CW (clockwise) increasing when viewing the clockwise rotating shaft |
| Measured value backlash | 0.005° |
| Response threshold | 0.003° |

¹⁾ Valid positional data can be read once this time has elapsed.

Electronics

| | |
|------------------------|-------------------------------------|
| Connection type | Male connector, M23, 12-pin, radial |
| Supply voltage | 10 ... 32 V |

¹⁾ Only with shaft stationary (note initialisation time).

| | |
|--|---|
| Operating current | Typ. 60 mA |
| Switching level of control inputs | Logic H = 0.7 x U _S , Logic L = 0 V ... 0.3 x U _S |
| Actuation of set button | ≥ 100 ms ¹⁾ |

¹⁾ Only with shaft stationary (note initialisation time).

Mechanics

| | |
|---------------------------------------|--|
| Mechanical design | Solid shaft, Servo flange |
| Shaft diameter | 6 mm |
| Shaft length | 10 mm |
| Characteristics of the shaft | With flat |
| Weight | Approx. 0.3 kg ¹⁾ |
| Housing material | Aluminum die cast |
| Start up torque | Typ. 0.25 Ncm |
| Operating torque | Typ. 0.2 Ncm |
| Permissible shaft loading | 20 N (radial) 10 N (axial) |
| Operating speed | ≤ 6,000 min ⁻¹ with shaft seal ≤ 10,000 min ⁻¹ without shaft seal ²⁾ |
| Moment of inertia of the rotor | 48 gcm ² |
| Bearing lifetime | 3.6 x 10 ⁹ revolutions |
| Angular acceleration | ≤ 500,000 rad/s ² |

¹⁾ Based on devices with male connector.

²⁾ If the shaft seal has been removed by the customer.

Ambient data

| | |
|--------------------------------------|--|
| EMC | According to EN 61000-6-2 and EN 61000-6-3 ¹⁾ |
| Enclosure rating | IP65, male connector (IEC 60529) ²⁾ |
| Permissible relative humidity | 90 % (Condensation not permitted) |
| Operating temperature range | -20 °C ... +85 °C |
| Storage temperature range | -40 °C ... +100 °C, without package |
| Resistance to shocks | 50 g, 11 ms (EN 60068-2-27) |
| Resistance to vibration | 20 g, 10 Hz ... 2,000 Hz (EN 60068-2-6) |

¹⁾ EMC according to the standards quoted is achieved if shielded cables are used.

²⁾ With mating connector fitted.

Certificates

| | |
|--|---|
| EU declaration of conformity | ✓ |
| UK declaration of conformity | ✓ |
| ACMA declaration of conformity | ✓ |
| Moroccan declaration of conformity | ✓ |
| China RoHS | ✓ |
| cULus certificate | ✓ |
| Information according to Art. 3 of Data Act (Regulation EU 2023/2854) | ✓ |

Classifications

| | |
|-----------------------|----------|
| ECLASS 5.0 | 27270502 |
| ECLASS 5.1.4 | 27270502 |
| ECLASS 6.0 | 27270590 |
| ECLASS 6.2 | 27270590 |
| ECLASS 7.0 | 27270502 |
| ECLASS 8.0 | 27270502 |
| ECLASS 8.1 | 27270502 |
| ECLASS 9.0 | 27270502 |
| ECLASS 10.0 | 27270502 |
| ECLASS 11.0 | 27270502 |
| ECLASS 12.0 | 27270502 |
| ETIM 5.0 | EC001486 |
| ETIM 6.0 | EC001486 |
| ETIM 7.0 | EC001486 |
| ETIM 8.0 | EC001486 |
| UNSPSC 16.0901 | 41112113 |

Dimensional drawing

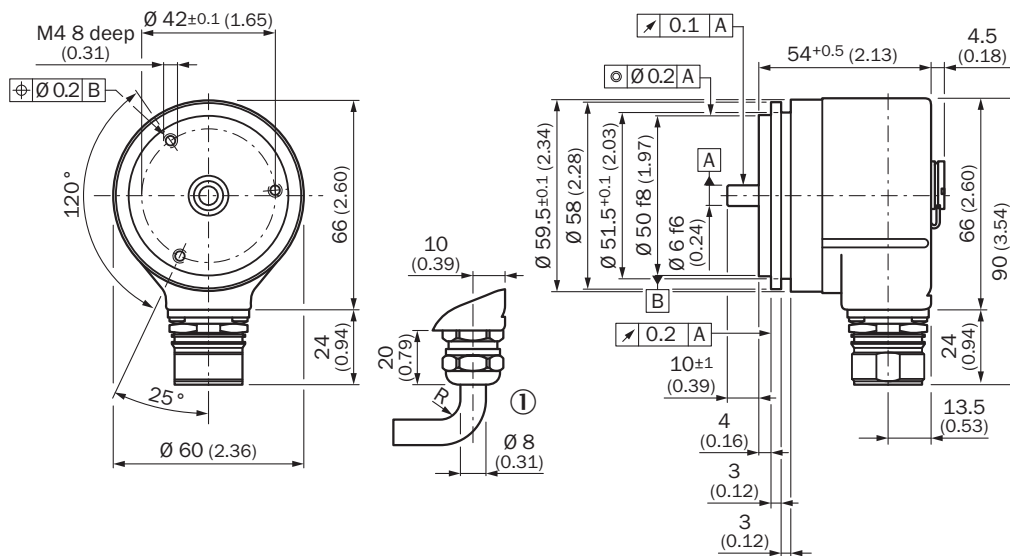

Dimensions in mm (inch)

General tolerances according to DIN ISO 2768-mk

① R = min. bending radius 40 mm



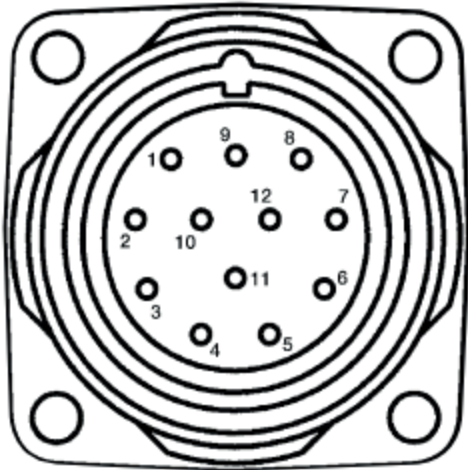

Anschlussbelegung



| PIN12-pin | Wire colors (cable connection)11-wire | Signal |
|-----------|---------------------------------------|----------------|
| 1 | Blue | GND |
| 2 | White | Data + |
| 3 | Yellow | Clock + |
| 4 | N.c. | N.c. |
| 5 | Pink | CW/CCW (V/R) |
| 6 | N.c. | N.c. |
| 7 | N.c. | N.c. |
| 8 | Red | U _S |
| 9 | Orange | SET |
| 10 | Brown | Data - |
| 11 | Violet | Clock - |
| 12 | N.c. | N.c. |

Recommended accessories

Other models and accessories → www.sick.com/ARS60

| | Brief description | Type | part no. |
|---|---|------------------|----------|
| connectors and cables | | | |
|  | <ul style="list-style-type: none"> Description: SSI, shielded, Incremental Connection type head A: Flying leads Connection type head B: Flying leads Signal type: SSI, Incremental Items supplied: By the meter Cable: 11-wire, PUR | LTG-2411-MW | 6027530 |
|  | <ul style="list-style-type: none"> Description: SSI, shielded, Incremental Connection type head A: Flying leads Connection type head B: Flying leads Signal type: SSI, Incremental Items supplied: By the meter Cable: 12-wire, PUR, halogen-free | LTG-2512-MW | 6027531 |
|  | <ul style="list-style-type: none"> Description: SSI, shielded, TTL, HTL, Incremental Connection type head A: Flying leads Connection type head B: Flying leads Signal type: SSI, TTL, HTL, Incremental Items supplied: By the meter Cable: 12-wire, UV and saltwater-resistant, PUR, halogen-free | LTG-2612-MW | 6028516 |
|  | <ul style="list-style-type: none"> Description: SSI, shielded, Incremental, HIPERFACE® Connection type head A: Flying leads Connection type head B: Flying leads Signal type: SSI, Incremental, HIPERFACE® Items supplied: By the meter Cable: 8-wire, PUR, halogen-free | LTG-2308-MWENC | 6027529 |
|  | <ul style="list-style-type: none"> Description: HIPERFACE®, shielded, SSI, Incremental Connection type head A: Female connector, M23, 12-pin, straight, A-coded Signal type: HIPERFACE®, SSI, Incremental Connection systems: Solder connection | DOS-2312-G | 6027538 |
|  | <ul style="list-style-type: none"> Description: HIPERFACE®, shielded, SSI, Incremental, RS-422 Connection type head A: Male connector, M23, 12-pin, straight, A-coded Signal type: HIPERFACE®, SSI, Incremental, RS-422 Connection systems: Solder connection | STE-2312-G | 6027537 |
|  | <ul style="list-style-type: none"> Description: SSI, shielded Connection type head A: Female connector, M23, 12-pin, straight Connection type head B: Flying leads Signal type: SSI Cable: 3 m, 12-wire, PUR, halogen-free Application: Zones with oils and lubricants | DOL-2312-G03MMA2 | 2029207 |
|  | <ul style="list-style-type: none"> Description: SSI, shielded Connection type head A: Female connector, M23, 12-pin, straight Connection type head B: Flying leads Signal type: SSI Cable: 1.5 m, 12-wire, PUR, halogen-free Application: Zones with oils and lubricants | DOL-2312-G1M5MA2 | 2029206 |
|  | <ul style="list-style-type: none"> Description: SSI, shielded Connection type head A: Female connector, M23, 12-pin, straight Connection type head B: Flying leads Signal type: SSI Cable: 5 m, 12-wire, PUR, halogen-free Application: Zones with oils and lubricants | DOL-2312-G05MMA2 | 2029208 |
|  | <ul style="list-style-type: none"> Description: SSI, shielded Connection type head A: Female connector, M23, 12-pin, straight Connection type head B: Flying leads Signal type: SSI Cable: 10 m, 12-wire, PUR, halogen-free Application: Zones with oils and lubricants | DOL-2312-G10MMA2 | 2029209 |
|  | <ul style="list-style-type: none"> Description: SSI, shielded Connection type head A: Female connector, M23, 12-pin, straight Connection type head B: Flying leads Signal type: SSI Cable: 20 m, 12-wire, PUR, halogen-free | DOL-2312-G20MMA2 | 2029210 |

| | Brief description | Type | part no. |
|---|--|------------------|----------|
|  | <ul style="list-style-type: none"> Application: Zones with oils and lubricants Description: SSI, shielded Connection type head A: Female connector, M23, 12-pin, straight Connection type head B: Flying leads Signal type: SSI Cable: 30 m, 12-wire, PUR, halogen-free Application: Zones with oils and lubricants | DOL-2312-G30MMA2 | 2029211 |
|  | <ul style="list-style-type: none"> Description: HIPERFACE[®], shielded, SSI, Incremental Connection type head A: Female connector, M23, 9-pin, straight, A-coded Signal type: HIPERFACE[®], SSI, Incremental Connection systems: Solder connection | DOS-2309-G | 6028533 |
|  | <ul style="list-style-type: none"> Description: HIPERFACE[®], shielded, SSI, Incremental Connection type head A: Female connector, M23, 12-pin, angled, A-coded Signal type: HIPERFACE[®], SSI, Incremental Connection systems: Solder connection | DOS-2312-W01 | 2072580 |
| Mounting systems | | | |
|  | <ul style="list-style-type: none"> Description: Mounting bell for encoder with servo flange, 50 mm spigot Items supplied: Mounting kit included | BEF-MG-50 | 5312987 |
|  | <ul style="list-style-type: none"> Description: Half-shell servo clamps (2 pcs.) for servo flanges with a 50 mm centering hub | BEF-WG-SF050 | 2029165 |
|  | <ul style="list-style-type: none"> Description: Servo clamps, large, for servo flange (clamps, eccentric fastener), 3 pcs, without mounting material Items supplied: Without mounting hardware | BEF-WK-SF | 2029166 |
| shaft adaptation | | | |
|  | <ul style="list-style-type: none"> Product segment: Shaft adaptation Product: Shaft couplings Description: Bellows coupling, shaft diameter 6 mm / 6 mm, maximum shaft offset: radial ± 0.25 mm, axial ± 0.4 mm, angular $\pm 4^\circ$; max. speed 10,000 rpm, -30°C to $+120^\circ\text{C}$, max. torque 120 Ncm; material: stainless steel bellows, aluminum hub | KUP-0606-B | 5312981 |
|  | <ul style="list-style-type: none"> Product segment: Shaft adaptation Product: Shaft couplings Description: Bellows coupling, shaft diameter 6 mm / 10 mm, maximum shaft offset: radial ± 0.25 mm, axial ± 0.4 mm, angular $\pm 4^\circ$; max. speed 10,000 rpm, -30°C to $+120^\circ\text{C}$, max. torque 120 Ncm; material: stainless steel bellows, aluminum hub | KUP-0610-B | 5312982 |
|  | <ul style="list-style-type: none"> Product segment: Shaft adaptation Product: Shaft couplings Description: Spring washer coupling, shaft diameter 6 mm / 10 mm, Maximum shaft offset: radial ± 0.3 mm, axial ± 0.4 mm, angular $\pm 2.5^\circ$; max. speed 12,000 rpm, -10° to $+80^\circ\text{C}$, max. torque 60 Ncm; material: aluminum flange, glass fiber-reinforced polyamide membrane and hardened steel coupling pin | KUP-0610-F | 5312985 |

SICK AT A GLANCE

SICK is one of the leading manufacturers of intelligent sensors and sensor solutions for industrial applications. A unique range of products and services creates the perfect basis for controlling processes securely and efficiently, protecting individuals from accidents and preventing damage to the environment.

We have extensive experience in a wide range of industries and understand their processes and requirements. With intelligent sensors, we can deliver exactly what our customers need. In application centers in Europe, Asia and North America, system solutions are tested and optimized in accordance with customer specifications. All this makes us a reliable supplier and development partner.

Comprehensive services complete our offering: SICK LifeTime Services provide support throughout the machine life cycle and ensure safety and productivity.

For us, that is “Sensor Intelligence.”

WORLDWIDE PRESENCE:

Contacts and other locations –www.sick.com