

PKS09-ATBM0220

Compact

WIRE DRAW ENCODERS

SICK
Sensor Intelligence.

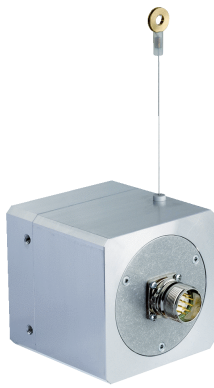

Ordering information

Type	part no.
PKS09-ATBM0220	1035242

Other models and accessories → www.sick.com/Compact



Detailed technical data

Safety-related parameters

MTTF_D (mean time to dangerous failure)	400 years (EN ISO 13849) ¹⁾
--	--

¹⁾ This product is a standard product and does not constitute a safety component as defined in the Machinery Directive. Calculation based on nominal load of components, average ambient temperature 40 °C, frequency of use 8760 h/a. All electronic failures are considered hazardous. For more information, see document no. 8015532.

Performance

Measurement range	0 m ... 2 m
Encoder	Incremental encoders
Pulses per revolution	765
Repeatability	≤ 0.15 mm
Linearity	≤ ± 0.7 mm

Interfaces

Communication interface	Incremental / TTL / RS-422
--------------------------------	----------------------------

Electronics

Connection type	Male connector, M23, 12-pin, radial
Supply voltage	4.5 V ... 5.5 V
Operating current	≤ 60 mA (without load)

Mechanics

Weight	1.5 kg
Measuring wire material	Highly flexible stranded steel (PA 12 sheathed)
Measuring wire diameter	0.6 mm
Housing material, wire draw mechanism	Aluminum

¹⁾ These values were measured at an ambient temperature of 25 °C. There may be variations at other temperatures.

²⁾ A cycle consists of the wire being pulled out and drawn in.

³⁾ The service life depends on the type of load. This is influenced by environmental conditions, the installation location, the measuring range in use, the traversing speed, and acceleration.

Spring return force	5 N ... 6 N ¹⁾
Length of wire pulled out per revolution	153 mm
Life of wire draw mechanism	Typ. 800,000 cycles ^{2) 3)}
Wire acceleration	≤ 20 m/s ²
Operating speed	3.5 m/s

¹⁾ These values were measured at an ambient temperature of 25 °C. There may be variations at other temperatures.

²⁾ A cycle consists of the wire being pulled out and drawn in.

³⁾ The service life depends on the type of load. This is influenced by environmental conditions, the installation location, the measuring range in use, the traversing speed, and acceleration.

Ambient data

EMC	According to EN 61000-6-2 and EN 61000-6-3
Enclosure rating	IP52, Note required mounting position (IEC 60529)
Operating temperature range	-10 °C ... +70 °C

Classifications

ECLASS 5.0	27270590
ECLASS 5.1.4	27270590
ECLASS 6.0	27270590
ECLASS 6.2	27270590
ECLASS 7.0	27270590
ECLASS 8.0	27270590
ECLASS 8.1	27270590
ECLASS 9.0	27270590
ECLASS 10.0	27270613
ECLASS 11.0	27270503
ECLASS 12.0	27270503
ETIM 5.0	EC001486
ETIM 6.0	EC001486
ETIM 7.0	EC001486
ETIM 8.0	EC001486
UNSPSC 16.0901	41112113

Certificates

EU declaration of conformity	✓
UK declaration of conformity	✓
ACMA declaration of conformity	✓
China RoHS	✓
cULus certificate	✓
Information according to Art. 3 of Data Act (Regulation EU 2023/2854)	✓



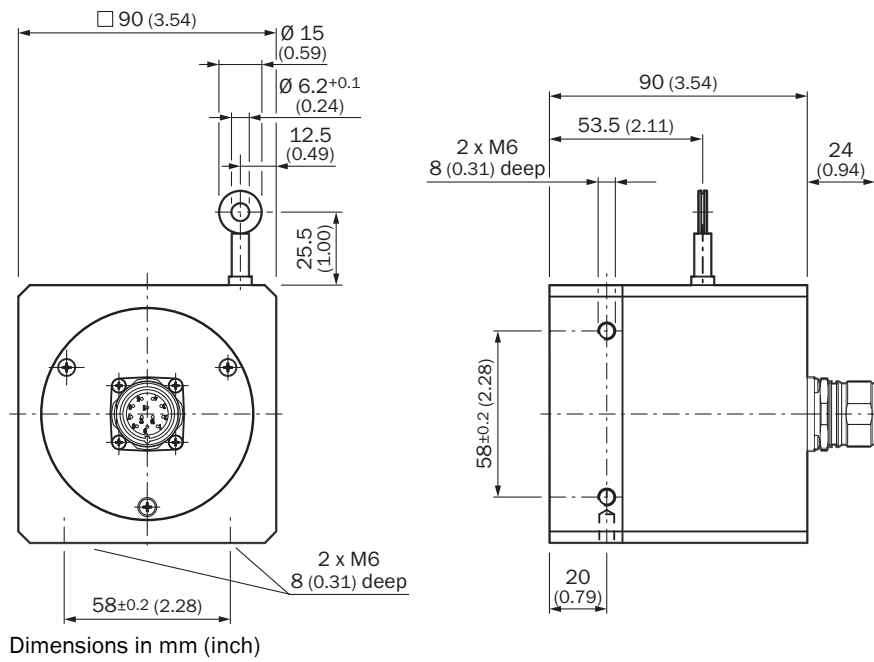

Dimensional drawing



Recommended accessories

Other models and accessories → www.sick.com/Compact

	Brief description	Type	part no.
connectors and cables			
	<ul style="list-style-type: none"> Description: Incremental, shielded Connection type head A: Female connector, M23, 12-pin, straight Connection type head B: Flying leads Signal type: Incremental Cable: 2 m, 11-wire, PUR Application: Zones with oils and lubricants 	DOL-2312-G02MLA3	2030682
	<ul style="list-style-type: none"> Description: Incremental, shielded Connection type head A: Female connector, M23, 12-pin, straight Connection type head B: Flying leads Signal type: Incremental Cable: 7 m, 11-wire, PUR Application: Zones with oils and lubricants 	DOL-2312-G07MLA3	2030685
	<ul style="list-style-type: none"> Description: Incremental, shielded Connection type head A: Female connector, M23, 12-pin, straight Connection type head B: Flying leads Signal type: Incremental Cable: 10 m, 11-wire, PUR Application: Zones with oils and lubricants 	DOL-2312-G10MLA3	2030688
	<ul style="list-style-type: none"> Description: Incremental, shielded Connection type head A: Female connector, M23, 12-pin, straight Connection type head B: Flying leads Signal type: Incremental Cable: 15 m, 11-wire, PUR Application: Zones with oils and lubricants 	DOL-2312-G15MLA3	2030692
	<ul style="list-style-type: none"> Description: SSI, shielded, Incremental Connection type head A: Flying leads Connection type head B: Flying leads Signal type: SSI, Incremental Items supplied: By the meter Cable: 11-wire, PUR 	LTG-2411-MW	6027530
	<ul style="list-style-type: none"> Description: Incremental, shielded Connection type head A: Female connector, M23, 12-pin, straight Connection type head B: Flying leads Signal type: Incremental Cable: 20 m, 11-wire, PUR Application: Zones with oils and lubricants 	DOL-2312-G20MLA3	2030695
	<ul style="list-style-type: none"> Description: SSI, shielded, Incremental Connection type head A: Flying leads Connection type head B: Flying leads Signal type: SSI, Incremental Items supplied: By the meter Cable: 12-wire, PUR, halogen-free 	LTG-2512-MW	6027531
	<ul style="list-style-type: none"> Description: Incremental, shielded Connection type head A: Female connector, M23, 12-pin, straight Connection type head B: Flying leads Signal type: Incremental Cable: 25 m, 11-wire, PUR Application: Zones with oils and lubricants 	DOL-2312-G25MLA3	2030699
	<ul style="list-style-type: none"> Description: SSI, shielded, TTL, HTL, Incremental Connection type head A: Flying leads Connection type head B: Flying leads Signal type: SSI, TTL, HTL, Incremental Items supplied: By the meter Cable: 12-wire, UV and saltwater-resistant, PUR, halogen-free 	LTG-2612-MW	6028516
	<ul style="list-style-type: none"> Description: Incremental, shielded Connection type head A: Female connector, M23, 12-pin, straight Connection type head B: Flying leads Signal type: Incremental Cable: 30 m, 11-wire, PUR Application: Zones with oils and lubricants 	DOL-2312-G30MLA3	2030702
	<ul style="list-style-type: none"> Description: Incremental, shielded Connection type head A: Female connector, M23, 12-pin, straight Connection type head B: Flying leads Signal type: Incremental 	DOL-2312-G1M5MA3	2029212

	Brief description	Type	part no.
	<ul style="list-style-type: none"> • Cable: 1.5 m, 12-wire, PUR, halogen-free • Application: Zones with oils and lubricants 		
	<ul style="list-style-type: none"> • Description: Incremental, shielded • Connection type head A: Female connector, M23, 12-pin, straight • Connection type head B: Flying leads • Signal type: Incremental • Cable: 3 m, 12-wire, PUR, halogen-free • Application: Zones with oils and lubricants 	DOL-2312-G03MMA3	2029213
	<ul style="list-style-type: none"> • Description: Incremental, shielded • Connection type head A: Female connector, M23, 12-pin, straight • Connection type head B: Flying leads • Signal type: Incremental • Cable: 5 m, 12-wire, PUR, halogen-free • Application: Zones with oils and lubricants 	DOL-2312-G05MMA3	2029214
	<ul style="list-style-type: none"> • Description: Incremental, shielded • Connection type head A: Female connector, M23, 12-pin, straight • Connection type head B: Flying leads • Signal type: Incremental • Cable: 10 m, 12-wire, PUR, halogen-free • Application: Zones with oils and lubricants 	DOL-2312-G10MMA3	2029215
	<ul style="list-style-type: none"> • Description: Incremental, shielded • Connection type head A: Female connector, M23, 12-pin, straight • Connection type head B: Flying leads • Signal type: Incremental • Cable: 20 m, 12-wire, PUR, halogen-free • Application: Zones with oils and lubricants 	DOL-2312-G20MMA3	2029216
	<ul style="list-style-type: none"> • Description: Incremental, shielded • Connection type head A: Female connector, M23, 12-pin, straight • Connection type head B: Flying leads • Signal type: Incremental • Cable: 30 m, 12-wire, PUR, halogen-free • Application: Zones with oils and lubricants 	DOL-2312-G30MMA3	2029217

SICK AT A GLANCE

SICK is one of the leading manufacturers of intelligent sensors and sensor solutions for industrial applications. A unique range of products and services creates the perfect basis for controlling processes securely and efficiently, protecting individuals from accidents and preventing damage to the environment.

We have extensive experience in a wide range of industries and understand their processes and requirements. With intelligent sensors, we can deliver exactly what our customers need. In application centers in Europe, Asia and North America, system solutions are tested and optimized in accordance with customer specifications. All this makes us a reliable supplier and development partner.

Comprehensive services complete our offering: SICK LifeTime Services provide support throughout the machine life cycle and ensure safety and productivity.

For us, that is “Sensor Intelligence.”

WORLDWIDE PRESENCE:

Contacts and other locations –www.sick.com