



PRF13-E1AM1020

HighLine

WIRE DRAW ENCODERS

SICK
Sensor Intelligence.



Ordering information

Type	part no.
PRF13-E1AM1020	1034337

Included in delivery: DFS60B-S1MA10000 (1), MRA-F130-110D2 (1)

Other models and accessories → www.sick.com/HighLine



Detailed technical data

Safety-related parameters

MTTF_D (mean time to dangerous failure)	300 years (EN ISO 13849-1) ¹⁾
--	--

¹⁾ This product is a standard product and does not constitute a safety component as defined in the Machinery Directive. Calculation based on nominal load of components, average ambient temperature 40°C, frequency of use 8760 h/a. All electronic failures are considered hazardous. For more information, see document no. 8015532.

Performance

Measurement range	0 m ... 10 m
Encoder	Incremental encoders
Resolution (wire draw + encoder)	0.03 mm ^{1) 2)}
Repeatability	≤ 1.5 mm ³⁾
Linearity	≤ ± 2 mm ³⁾
Hysteresis	≤ 3 mm ³⁾

¹⁾ The values shown have been rounded.

²⁾ Example calculation based on the PRF08 with HTL Push Pull: 200 mm (wire draw length per revolution - see Mechanical data): 2,000 (pulses per revolution) = 0.1 mm (resolution of wire draw + encoder combination).

³⁾ Value applies to wire draw mechanism.

Interfaces

Communication interface	Incremental / HTL / Push-Pull
Programmable/configurable	✓
Factory setting	The built-on DFS60 encoders are programmed to the specified number of lines and interface prior to delivery. The electrical interface (TTL/HTL) and the number of lines (up to max. 10,000 lines) can be set in accordance with customer requirements with our programming devices for DFS60 encoders, which are available separately.

Electronics

Connection type	Male connector, M23, 12-pin, radial
Supply voltage	10 V ... 32 V
Power consumption	≤ 0.7 W (without load)

Mechanics

Weight	3.8 kg
Measuring wire material	Highly flexible stranded steel 1,4401 stainless steel V4A
Measuring wire diameter	1.35 mm
Weight (measuring wire)	7.1 g/m
Housing material, wire draw mechanism	Aluminum (anodised), plastic
Spring return force	10 N ... 20 N ¹⁾
Length of wire pulled out per revolution	332.4 mm
Life of wire draw mechanism	Typ. 1,000,000 cycles ^{2) 3)}
Actual wire draw length	10.2 m
Wire acceleration	40 m/s ²
Operating speed	8 m/s
Mounted encoder	DFS60, DFS60B-S1MA10000, 1056866
Mounted mechanic	MRA-F130-110D2, 6028627

¹⁾ These values were measured at an ambient temperature of 25 °C. There may be variations at other temperatures.

²⁾ Average values, which depend on the application.

³⁾ The service life depends on the type of load. This is influenced by environmental conditions, the installation location, the measuring range in use, the traversing speed, and acceleration.

Ambient data

EMC	According to EN 61000-6-2 and EN 61000-6-3
Enclosure rating	IP64, mounted mechanic IP67, Encoder (IEC 60529) ¹⁾
Operating temperature range	-30 °C ... +70 °C

¹⁾ With mating connector fitted.

Classifications

ECLASS 5.0	27270590
ECLASS 5.1.4	27270590
ECLASS 6.0	27270590
ECLASS 6.2	27270590
ECLASS 7.0	27270590
ECLASS 8.0	27270590
ECLASS 8.1	27270590
ECLASS 9.0	27270590
ECLASS 10.0	27270613
ECLASS 11.0	27270503
ECLASS 12.0	27270503
ETIM 5.0	EC001486
ETIM 6.0	EC001486
ETIM 7.0	EC001486
ETIM 8.0	EC001486
UNSPSC 16.0901	41112113

Certificates

EU declaration of conformity	✓
UK declaration of conformity	✓
ACMA declaration of conformity	✓
Moroccan declaration of conformity	✓
China RoHS	✓

Dimensional drawing

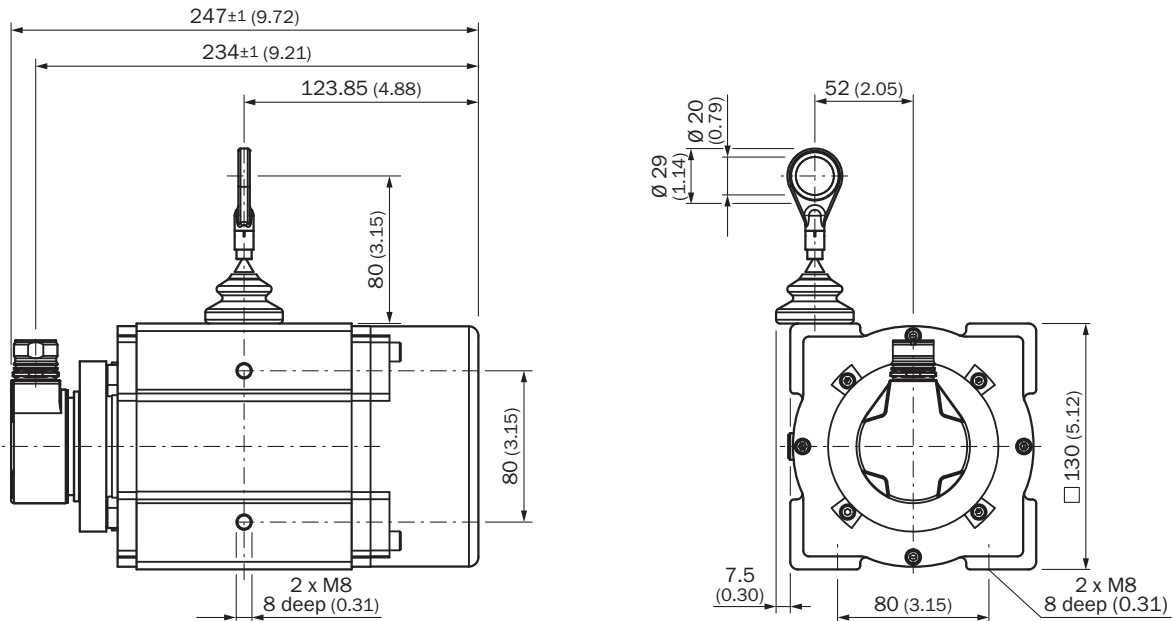

Dimensions in mm (inch)

Anschlussbelegung

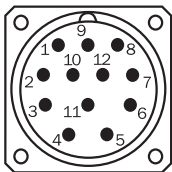

view of M23 male device connector on encoder





PIN Male connector M12, 8-pin	PIN Male connector M23, 12-pin	Wire colors (cable connection)	TTL/HTL signal	Sin/Cos 1.0 V _{PP}	Explanation
1	6	Brown	\bar{A}	COS-	Signal wire
2	5	White	A	COS+	Signal wire
3	1	Black	\bar{B}	SIN-	Signal wire
4	8	Pink	B	SIN+	Signal wire
5	4	Yellow	\bar{Z}	\bar{Z}	Signal wire
6	3	Purple	Z	Z	Signal wire



PINMale connector M12, 8-pin	PINMale connector M23, 12-pin	Wire colors (cable connection)	TTL/HTL signal	Sin/Cos 1.0 V _{PP}	Explanation
7	10	Blue	GND	GND	Ground connection
8	12	Red	+U _S	+U _S	Supply voltage
-	9	-	N.c.	N.c.	Not assigned
-	2	-	N.c.	N.c.	Not assigned
-	11	-	N.c.	N.c.	Not assigned
-	7 ¹⁾	Orange	0-SET ¹⁾	N.c.	Set zero pulse ¹⁾
Shielding	Shielding	Shielding	Shielding	Shielding	Shielding connected to housing on encoder side. Connected to ground on control side.

¹⁾For electrical interfaces only: M, U, V, W with 0-SET function on PIN 7 on M23 plug. The 0-SET input is used to set the zero pulse to the current shaft position. If the 0-SET input is applied to US for longer than 250 ms after it has previously been open or applied to GND for at least 1,000 ms, the current shaft position is assigned zero pulse signal "Z".

Recommended accessories

Other models and accessories → www.sick.com/HighLine

	Brief description	Type	part no.
Mounting systems			
	<ul style="list-style-type: none"> Description: Joint ball for later insertion in wire end ring with 20 mm diameter. The use of this joint ball enables movement in multiple levels of freedom. 	Joint protection for wire rope BTF/PRF/MRA	5318683
	<ul style="list-style-type: none"> Description: Compressed air attachment for MRA-F080... and MRA-F130... HighLine wire draw mechanism 	MRA-F-P	6073769
	<ul style="list-style-type: none"> Description: Additional brush attachment for wire draw mechanism MRA-F130 (5 m, 10 m, 20 m and 30 m from HighLine series) 	MRA-F130-B	6038562
	<ul style="list-style-type: none"> Description: Wire draw deflection pulley for wire draw mechanism MRA-F130 (5m, 10m, 20m and 30m from HighLine series) 	MRA-F130-R	6028631

	Brief description	Type	part no.
programming devices			
	<ul style="list-style-type: none"> Product segment: Programming devices Product: PGT-10 Pro Description: Programming unit display for programmable SICK DFS60, DFV60, AFS/AFM60, AHS/AHM36 encoders, and wire draw encoder with DFS60, AFS/AFM60 and AHS/AHM36. Compact dimensions, low weight, and intuitive operation. Items supplied: 1 x PGT-10-Pro stand-alone programming tool, 4 x alkaline type batteries, 1.5 V Mignon (AA) 	PGT-10-Pro	1072254
	<ul style="list-style-type: none"> Product segment: Programming devices Product: PGT-08-S Description: USB programming unit, for programmable SICK encoders AFS60, AFM60, DFS60, VFS60, DFV60 and wire draw encoders with programmable encoders. Not compatible with the portable SOPAS ET versions. 	PGT-08-S	1036616
Wire draw mechanism			
	<ul style="list-style-type: none"> Product segment: Wire draw mechanism Product family: Wire draw mechanism for wire draw encoders Description: HighLine wire draw mechanism for servo flange with 6 mm shaft, measuring range 0 m ... 10 m Items supplied: Without encoder 	MRA-F130-110D2	6028627

	Brief description	Type	part no.
connectors and cables			
	<ul style="list-style-type: none"> Description: Incremental, shielded Connection type head A: Female connector, M23, 12-pin, straight Connection type head B: Flying leads Signal type: Incremental Cable: 2 m, 11-wire, PUR Application: Zones with oils and lubricants 	DOL-2312-G02MLA3	2030682
	<ul style="list-style-type: none"> Description: Incremental, shielded Connection type head A: Female connector, M23, 12-pin, straight Connection type head B: Flying leads Signal type: Incremental Cable: 7 m, 11-wire, PUR Application: Zones with oils and lubricants 	DOL-2312-G07MLA3	2030685
	<ul style="list-style-type: none"> Description: Incremental, shielded Connection type head A: Female connector, M23, 12-pin, straight Connection type head B: Flying leads Signal type: Incremental Cable: 10 m, 11-wire, PUR Application: Zones with oils and lubricants 	DOL-2312-G10MLA3	2030688
	<ul style="list-style-type: none"> Description: Incremental, shielded Connection type head A: Female connector, M23, 12-pin, straight Connection type head B: Flying leads Signal type: Incremental Cable: 15 m, 11-wire, PUR Application: Zones with oils and lubricants 	DOL-2312-G15MLA3	2030692
	<ul style="list-style-type: none"> Description: Incremental, shielded Connection type head A: Female connector, M23, 12-pin, straight Connection type head B: Flying leads Signal type: Incremental Cable: 20 m, 11-wire, PUR Application: Zones with oils and lubricants 	DOL-2312-G20MLA3	2030695
	<ul style="list-style-type: none"> Description: Incremental, shielded Connection type head A: Female connector, M23, 12-pin, straight Connection type head B: Flying leads Signal type: Incremental Cable: 25 m, 11-wire, PUR Application: Zones with oils and lubricants 	DOL-2312-G25MLA3	2030699
	<ul style="list-style-type: none"> Description: Incremental, shielded Connection type head A: Female connector, M23, 12-pin, straight Connection type head B: Flying leads Signal type: Incremental Cable: 30 m, 11-wire, PUR Application: Zones with oils and lubricants 	DOL-2312-G30MLA3	2030702
	<ul style="list-style-type: none"> Description: Incremental, shielded Connection type head A: Female connector, M23, 12-pin, straight Connection type head B: Flying leads Signal type: Incremental Cable: 1.5 m, 12-wire, PUR, halogen-free Application: Zones with oils and lubricants 	DOL-2312-G1M5MA3	2029212
	<ul style="list-style-type: none"> Description: Incremental, shielded Connection type head A: Female connector, M23, 12-pin, straight Connection type head B: Flying leads Signal type: Incremental Cable: 3 m, 12-wire, PUR, halogen-free Application: Zones with oils and lubricants 	DOL-2312-G03MMA3	2029213
	<ul style="list-style-type: none"> Description: Incremental, shielded Connection type head A: Female connector, M23, 12-pin, straight Connection type head B: Flying leads Signal type: Incremental Cable: 5 m, 12-wire, PUR, halogen-free Application: Zones with oils and lubricants 	DOL-2312-G05MMA3	2029214
	<ul style="list-style-type: none"> Description: Incremental, shielded Connection type head A: Female connector, M23, 12-pin, straight Connection type head B: Flying leads Signal type: Incremental Cable: 10 m, 12-wire, PUR, halogen-free 	DOL-2312-G10MMA3	2029215

	Brief description	Type	part no.
	<ul style="list-style-type: none"> Application: Zones with oils and lubricants Description: Incremental, shielded Connection type head A: Female connector, M23, 12-pin, straight Connection type head B: Flying leads Signal type: Incremental Cable: 20 m, 12-wire, PUR, halogen-free Application: Zones with oils and lubricants 	DOL-2312-G20MMA3	2029216
	<ul style="list-style-type: none"> Description: Incremental, shielded Connection type head A: Female connector, M23, 12-pin, straight Connection type head B: Flying leads Signal type: Incremental Cable: 30 m, 12-wire, PUR, halogen-free Application: Zones with oils and lubricants 	DOL-2312-G30MMA3	2029217
	<ul style="list-style-type: none"> Description: HIPERFACE[®], shielded, SSI, Incremental Connection type head A: Female connector, M23, 12-pin, straight, A-coded Signal type: HIPERFACE[®], SSI, Incremental Connection systems: Solder connection 	DOS-2312-G02	2077057
	<ul style="list-style-type: none"> Description: HIPERFACE[®], shielded, SSI, Incremental Connection type head A: Female connector, M23, 12-pin, angled, A-coded Signal type: HIPERFACE[®], SSI, Incremental Connection systems: Solder connection 	DOS-2312-W01	2072580

SICK AT A GLANCE

SICK is one of the leading manufacturers of intelligent sensors and sensor solutions for industrial applications. A unique range of products and services creates the perfect basis for controlling processes securely and efficiently, protecting individuals from accidents and preventing damage to the environment.

We have extensive experience in a wide range of industries and understand their processes and requirements. With intelligent sensors, we can deliver exactly what our customers need. In application centers in Europe, Asia and North America, system solutions are tested and optimized in accordance with customer specifications. All this makes us a reliable supplier and development partner.

Comprehensive services complete our offering: SICK LifeTime Services provide support throughout the machine life cycle and ensure safety and productivity.

For us, that is “Sensor Intelligence.”

WORLDWIDE PRESENCE:

Contacts and other locations –www.sick.com