

ATM60-CAH13x13

ATM60

ABSOLUTE ENCODERS

SICK
Sensor Intelligence.

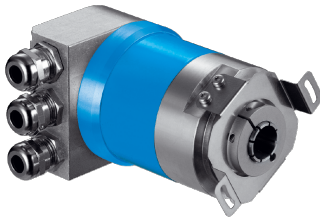

Ordering information

Type	part no.
ATM60-CAH13x13	1030026

Other models and accessories → www.sick.com/ATM60

Illustration may differ

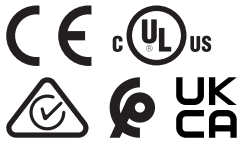

Detailed technical data

Safety-related parameters

MTTF_D (mean time to dangerous failure)	150 years (EN ISO 13849-1) ¹⁾
--	--

¹⁾ This product is a standard product and does not constitute a safety component as defined in the Machinery Directive. Calculation based on nominal load of components, average ambient temperature 40 °C, frequency of use 8760 h/a. All electronic failures are considered hazardous. For more information, see document no. 8015532.

Performance

Number of steps per revolution (max. resolution)	8,192 (13 bit)
Number of revolutions	8,192 (13 bit)
Max. resolution (number of steps per revolution x number of revolutions)	13 bit x 13 bit (8,192 x 8,192)
Measuring step	0.043 °
Error limits G	± 0.25 ° ¹⁾
Repeatability standard deviation σ_r	0.1 ° ²⁾

¹⁾ In accordance with DIN ISO 1319-1, position of the upper and lower error limit depends on the installation situation, specified value refers to a symmetrical position, i.e. deviation in upper and lower direction is the same.

²⁾ In accordance with DIN ISO 55350-13; 68.3% of the measured values are inside the specified area.

Interfaces

Communication interface	CANopen
Data protocol	Communication Profile DS 301 V4.0, Device Profile DSP 406 V 2.0
Address setting	0 ... 63, DIP switches or protocol
Data transmission rate (baud rate)	10 kBaud, 20 kBaud, 50 kBaud, 125 kBaud, 250 kBaud, 500 kBaud, 1 MBaud, DIP switches or protocol
Initialization time	1,250 ms ¹⁾
Position forming time	0.25 ms
Status information	2-colours LED for CAN controller status
Bus termination	DIP switch ²⁾
Set (electronic adjustment)	Via PRESET push button or protocol

¹⁾ Valid positional data can be read once this time has elapsed.

²⁾ Should only be connected in the final device.

Electronics

Connection type	Bus adapter ¹⁾
Supply voltage	10 ... 32 V
Power consumption	≤ 2 W (without load)
Reverse polarity protection	✓

¹⁾ Order bus adapter separately.

Mechanics

Mechanical design	Blind hollow shaft
Shaft diameter	15 mm ¹⁾
Weight	0.59 kg ²⁾
Shaft material	Stainless steel
Flange material	Aluminum
Start up torque	1.2 Ncm (+20 °C), with shaft seal
Operating torque	0.8 Ncm (+20 °C), with shaft seal
Permissible movement static	± 0.3 mm (radial) ± 0.5 mm (axial)
Permissible movement dynamic	± 0.1 mm (radial) ± 0.2 mm (axial)
Operating speed	≤ 3,000 min ⁻¹ ³⁾
Moment of inertia of the rotor	55 gcm ²
Bearing lifetime	3.6 x 10 ⁹ revolutions
Angular acceleration	≤ 500,000 rad/s ²

¹⁾ Collets for 6, 8, 10, 12, 14 mm and 1/4", 3/8" and 1/2" as accessories, separate order item. For 15 mm shaft diameter collet is not needed.

²⁾ Based on encoder with male connector.

³⁾ Allow for self-heating of 3.3 K per 1,000 rpm when designing the operating temperature range.

Ambient data

EMC	According to EN 61000-6-2 and EN 61000-6-3
Enclosure rating	IP67, with shaft seal (IEC 60529) ¹⁾ IP43, without shaft seal, on encoder flange not sealed (IEC 60529) ¹⁾ IP66, without shaft seal, on encoder flange sealed (IEC 60529) ¹⁾
Permissible relative humidity	98 %
Operating temperature range	-20 °C ... +85 °C
Storage temperature range	-40 °C ... +100 °C, without package
Resistance to shocks	100 g, 6 ms (EN 60068-2-27)
Resistance to vibration	20 g, 10 Hz ... 2,000 Hz (EN 60068-2-6)

¹⁾ With mating connector fitted.

Certificates

EU declaration of conformity	✓
UK declaration of conformity	✓
ACMA declaration of conformity	✓
Moroccan declaration of conformity	✓

China RoHS	✓
cULus certificate	✓

Classifications

ECLASS 5.0	27270502
ECLASS 5.1.4	27270502
ECLASS 6.0	27270590
ECLASS 6.2	27270590
ECLASS 7.0	27270502
ECLASS 8.0	27270502
ECLASS 8.1	27270502
ECLASS 9.0	27270502
ECLASS 10.0	27270502
ECLASS 11.0	27270502
ECLASS 12.0	27270502
ETIM 5.0	EC001486
ETIM 6.0	EC001486
ETIM 7.0	EC001486
ETIM 8.0	EC001486
UNSPSC 16.0901	41112113

Dimensional drawing

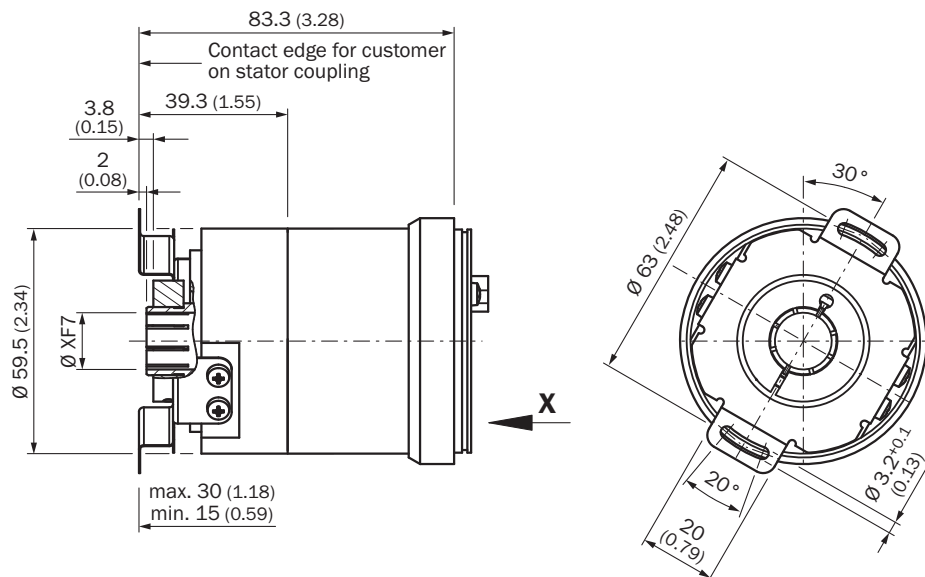

Dimensions in mm (inch)

M12 male connector (bus adapter)

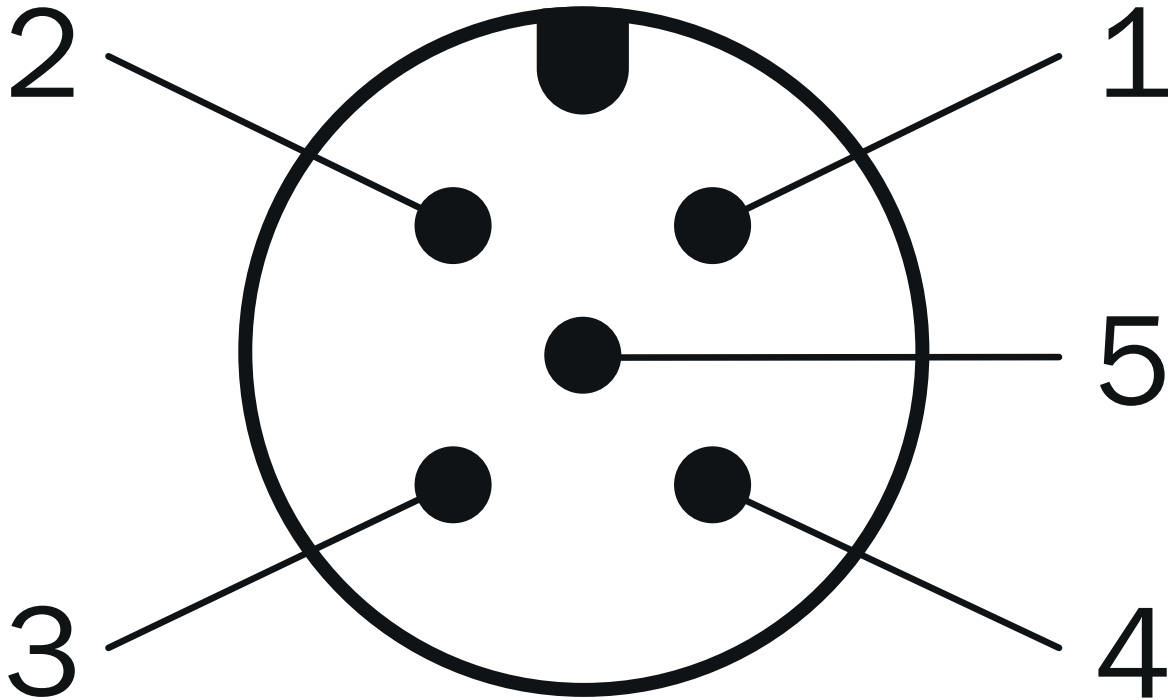

IN/US

Terminal strip	Male device connector	Signal	Explanation
1	1	shield	Screen
2	2	U_S (24 V)	Operating voltage 10 ... 32 V
3	3	GND (COM)	0 V (GND)
4	4	CAN _H	CAN Bus Signal high
5	5	CAN _L	CAN Bus Signal low
6	-	CAN _H	CAN Bus Signal high
7	-	CAN _L	CAN Bus Signal low
8	-	GND (COM)	0 V (GND)
9	-	U_S (24 V)	Operating voltage 10 ... 32 V

M12 female connector (bus adapter)

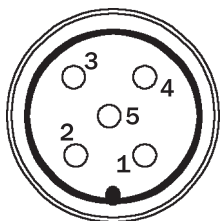

OUT/US (female contact)

Terminal strip	Male device connector	Signal	Explanation
1	1	shield	Screen
2	2	U _S (24 V)	Operating voltage 10 ... 32 V
3	3	GND (COM)	0 V (GND)
4	4	CAN _H	CAN Bus Signal high
5	5	CAN _L	CAN Bus Signal low
6	-	CAN _H	CAN Bus Signal high
7	-	CAN _L	CAN Bus Signal low
8	-	GND (COM)	0 V (GND)
9	-	U _S (24 V)	Operating voltage 10 ... 32 V

PIN assignment

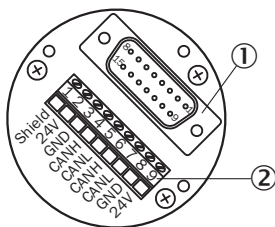









① Internal plug connector to encoder







② external connection to the bus

Terminal strip	Male device connector	Signal	Explanation
1	1	shield	Screen
2	2	U _S (24 V)	Operating voltage 10 ... 32 V
3	3	GND (COM)	0 V (GND)
4	4	CAN _H	CAN Bus Signal high
5	5	CAN _L	CAN Bus Signal low
6	-	CAN _H	CAN Bus Signal high
7	-	CAN _L	CAN Bus Signal low
8	-	GND (COM)	0 V (GND)
9	-	U _S (24 V)	Operating voltage 10 ... 32 V

Recommended accessories

Other models and accessories → www.sick.com/ATM60

	Brief description	Type	part no.
connectors and cables			
	<ul style="list-style-type: none"> • Connection type head A: Female connector, M12, 5-pin, straight, A-coded • Connection type head B: Male connector, M12, 5-pin, straight, A-coded • Signal type: Fieldbus, CANopen, DeviceNet™ • Cable: 6 m, 5-wire, PUR, halogen-free • Description: Fieldbus, unshielded, CANopen, DeviceNet™ 	DSL-1205-G06MK	6028327
	<ul style="list-style-type: none"> • Description: CANopen, shielded, DeviceNet™ • Connection type head A: Flying leads • Connection type head B: Flying leads • Signal type: CANopen, DeviceNet™ • Items supplied: By the meter • Cable: 4-wire, twisted pair • Note: Wire shield Al-Pt film, overall shield C-screen tin-plated 	LTG-2804-MW	6028328
	<ul style="list-style-type: none"> • Description: CANopen, shielded, DeviceNet™ • Connection type head A: Female connector, M12, 5-pin, straight, A-coded • Signal type: CANopen, DeviceNet™ • Connection systems: Screw-type terminals • Permitted cross-section: ≤ 0.75 mm² 	D0S-1205-GA	6027534
	<ul style="list-style-type: none"> • Description: CANopen, shielded, DeviceNet™ • Connection type head A: Male connector, M12, 5-pin, straight, A-coded • Signal type: CANopen, DeviceNet™ • Connection systems: Screw-type terminals • Permitted cross-section: ≤ 0.75 mm² 	STE-1205-GA	6027533
integration modules and adapters			
		AD-ATM60-KR1CO	2029230
		AD-ATM60-KR2CO	2029231
		AD-ATM60-KR3CO	2029232
		AD-ATM60-SR1CO	2031686
		AD-ATM60-SR2CO	2020935

	Brief description	Type	part no.
shaft adaptation			
	<ul style="list-style-type: none"> • Product segment: Shaft adaptation • Product: Collets • Description: Collet for blind hollow shaft, shaft diameter 12 mm, outer diameter 15 mm 	SPZ-012-AD-A	2029179
	<ul style="list-style-type: none"> • Product segment: Shaft adaptation • Product: Collets • Description: Collet for blind hollow shaft, shaft diameter 1/2" (12.7 mm), outer diameter 15 mm 	SPZ-1E2-AD-A	2029180
	<ul style="list-style-type: none"> • Product segment: Shaft adaptation • Product: Collets • Description: Collet for blind hollow shaft, shaft diameter 6 mm, outer diameter 15 mm 	SPZ-006-AD-A	2029174
	<ul style="list-style-type: none"> • Product segment: Shaft adaptation • Product: Collets • Description: Collet for blind hollow shaft, shaft diameter 1/4" (6.35 mm), outer diameter 15 mm 	SPZ-1E4-AD-A	2029175
	<ul style="list-style-type: none"> • Product segment: Shaft adaptation • Product: Collets • Description: Collet for blind hollow shaft, shaft diameter 8 mm, outer diameter 15 mm 	SPZ-008-AD-A	2029176
	<ul style="list-style-type: none"> • Product segment: Shaft adaptation • Product: Collets • Description: Collet for blind hollow shaft, shaft diameter 3/8" (9.525 mm), outer diameter 15 mm 	SPZ-3E8-AD-A	2029177
	<ul style="list-style-type: none"> • Product segment: Shaft adaptation • Product: Collets • Description: Collet for blind hollow shaft, shaft diameter 10 mm, outer diameter 15 mm 	SPZ-010-AD-A	2029178

SICK AT A GLANCE

SICK is one of the leading manufacturers of intelligent sensors and sensor solutions for industrial applications. A unique range of products and services creates the perfect basis for controlling processes securely and efficiently, protecting individuals from accidents and preventing damage to the environment.

We have extensive experience in a wide range of industries and understand their processes and requirements. With intelligent sensors, we can deliver exactly what our customers need. In application centers in Europe, Asia and North America, system solutions are tested and optimized in accordance with customer specifications. All this makes us a reliable supplier and development partner.

Comprehensive services complete our offering: SICK LifeTime Services provide support throughout the machine life cycle and ensure safety and productivity.

For us, that is “Sensor Intelligence.”

WORLDWIDE PRESENCE:

Contacts and other locations –www.sick.com