

ATM60-AAK12x12

ATM60

ABSOLUTE ENCODERS

SICK
Sensor Intelligence.

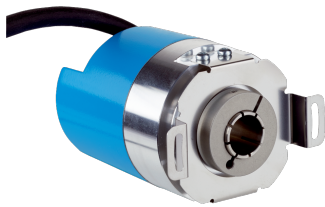
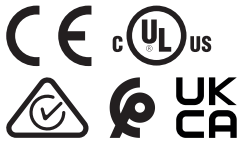

Illustration may differ



Ordering information

Type	part no.
ATM60-AAK12x12	1030010

Other models and accessories → www.sick.com/ATM60

Detailed technical data

Safety-related parameters

MTTF_D (mean time to dangerous failure)	150 years (EN ISO 13849-1) ¹⁾
----------------------------------------------------------	------------------------------------------

¹⁾ This product is a standard product and does not constitute a safety component as defined in the Machinery Directive. Calculation based on nominal load of components, average ambient temperature 40°C, frequency of use 8760 h/a. All electronic failures are considered hazardous. For more information, see document no. 8015532.

Performance

Number of steps per revolution (max. resolution)	8,192 (13 bit)
Number of revolutions	8,192 (13 bit)
Max. resolution (number of steps per revolution x number of revolutions)	13 bit x 13 bit (8,192 x 8,192)
Resolution	Maximum permissible resolution: 25 bit (12 bit singleturn x 13 bit multiturn or 13 bit singleturn x 12 bit multiturn).
Measuring step	0.043°
Error limits G	± 0.25° ¹⁾
Repeatability standard deviation σ_r	0.1° ²⁾

¹⁾ In accordance with DIN ISO 1319-1, position of the upper and lower error limit depends on the installation situation, specified value refers to a symmetrical position, i.e. deviation in upper and lower direction is the same.

²⁾ In accordance with DIN ISO 55350-13; 68.3% of the measured values are inside the specified area.

Interfaces

Communication interface	SSI
Initialization time	1,050 ms ¹⁾
Position forming time	0.15 ms
Parameterising data	Number of steps per revolution Number of revolutions Code type Electronic adjustment
Code type	Gray, binary
Code sequence parameter adjustable	CW/CCW (V/R)

¹⁾ Valid positional data can be read once this time has elapsed.

²⁾ Minimum, LOW level (Clock +): 500 ns.

Clock frequency	1 MHz ²⁾
Set (electronic adjustment)	H-active (L = 0 - 4,7 V, H = 10 - Us V)
CW/CCW (counting sequence when turning)	L-active (L = 0 - 1,5 V, H = 2,0 - Us V)

¹⁾ Valid positional data can be read once this time has elapsed.

²⁾ Minimum, LOW level (Clock +): 500 ns.

Electronics

Connection type	Cable, 12-wire, radial, 1.5 m
Supply voltage	10 ... 32 V
Power consumption	≤ 0.8 W (without load)
Reverse polarity protection	✓

Mechanics

Mechanical design	Blind hollow shaft
Shaft diameter	15 mm ¹⁾
Weight	0.4 kg ²⁾
Shaft material	Stainless steel
Flange material	Aluminum
Start up torque	1.2 Ncm (+20 °C), with shaft seal
Operating torque	0.8 Ncm (+20 °C), with shaft seal
Permissible movement static	± 0.3 mm (radial) ± 0.5 mm (axial)
Permissible movement dynamic	± 0.1 mm (radial) ± 0.2 mm (axial)
Operating speed	≤ 3,000 min ⁻¹ ³⁾
Moment of inertia of the rotor	55 gcm ²
Bearing lifetime	3.6 x 10 ⁹ revolutions
Angular acceleration	≤ 500,000 rad/s ²

¹⁾ Collets for 6, 8, 10, 12, 14 mm and 1/4", 3/8" and 1/2" as accessories, separate order item. For 15 mm shaft diameter collet is not needed.

²⁾ Based on encoder with male connector.

³⁾ Allow for self-heating of 3.3 K per 1,000 rpm when designing the operating temperature range.

Ambient data

EMC	According to EN 61000-6-2 and EN 61000-6-3
Enclosure rating	IP67, with shaft seal (IEC 60529) ¹⁾ IP43, without shaft seal, on encoder flange not sealed (IEC 60529) ¹⁾ IP65, without shaft seal, on encoder flange sealed (IEC 60529) ¹⁾
Permissible relative humidity	98 %
Operating temperature range	-20 °C ... +85 °C
Storage temperature range	-40 °C ... +100 °C, without package
Resistance to shocks	100 g, 6 ms (EN 60068-2-27)
Resistance to vibration	20 g, 10 Hz ... 2,000 Hz (EN 60068-2-6)

¹⁾ With mating connector fitted.

Certificates

EU declaration of conformity	✓
UK declaration of conformity	✓
ACMA declaration of conformity	✓
Moroccan declaration of conformity	✓
China RoHS	✓
cULus certificate	✓

Classifications

ECLASS 5.0	27270502
ECLASS 5.1.4	27270502
ECLASS 6.0	27270590
ECLASS 6.2	27270590
ECLASS 7.0	27270502
ECLASS 8.0	27270502
ECLASS 8.1	27270502
ECLASS 9.0	27270502
ECLASS 10.0	27270502
ECLASS 11.0	27270502
ECLASS 12.0	27270502
ETIM 5.0	EC001486
ETIM 6.0	EC001486
ETIM 7.0	EC001486
ETIM 8.0	EC001486
UNSPSC 16.0901	41112113

Dimensional drawing

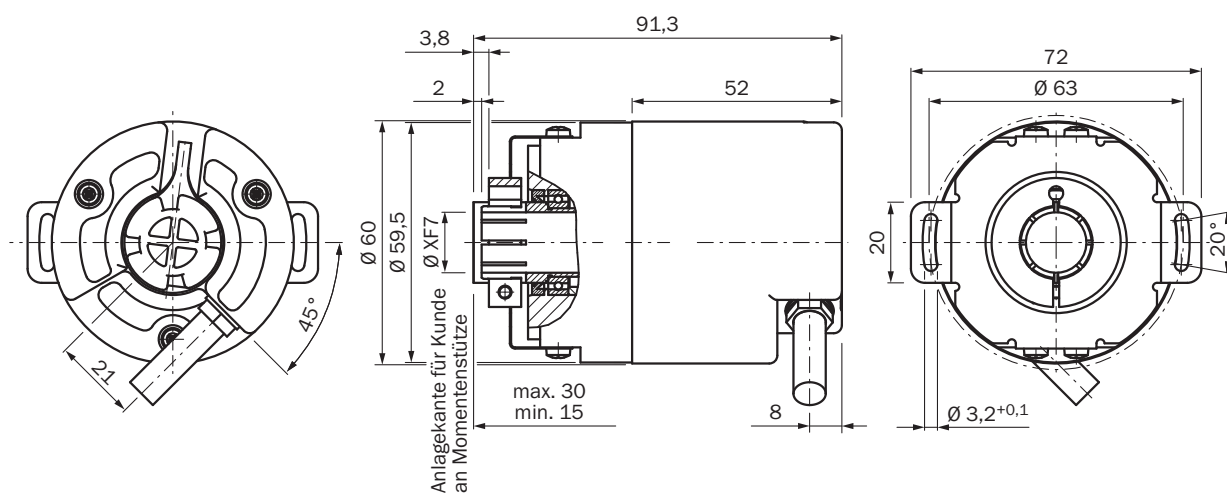

Dimensions in mm (inch)

PIN assignment

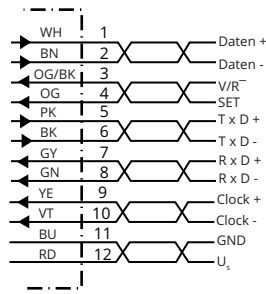

PIN	Signal	Wire colors (cable connection)	Explanation
1	GND	Blue	Ground connection
2	Data +	White	Interface signals
3	Clock +	Yellow	Interface signals
4	R x D +	Gray	RS-422 programming lines
5	R x D -	Green	RS-422 programming lines
6	T x D +	Pink	RS-422 programming lines
7	T x D -	Black	RS-422 programming lines
8	U _s	Red	Operating voltage
9	SET ¹⁾	Orange	Electronic adjustment
10	Data -	Brown	Interface signals
11	Clock -	Purple	Interface signals
12	V/R ²⁾	Orange-black	Sequence in direction of rotation
-	Screen	-	Housing potential













SET = This input activates the electronic zero set. If the SET cable is set to U_s for more than 100 ms, the mechanical position corresponds to the 0 value, i.e., the predetermined SET value.

V/R = Forwards/Reverse: This input programs the counting direction for the encoder. When it is not connected, this input is set to HIGH. If the encoder shaft is rotated clockwise (to the right) as viewed when facing the shaft, it counts in ascending order. If it should count in ascending order when the shaft is rotated counterclockwise (to the left), then this connection must be permanently set to LOW level (GND).

Recommended accessories

Other models and accessories → www.sick.com/ATM60

	Brief description	Type	part no.
programming devices			
	<ul style="list-style-type: none"> Product segment: Programming devices Product: PGT-01-S Description: Programming tool for ATM60, ATM90, and KH53 Items supplied: Power supply, interface, link cable, encoder cable, and software 	PGT-01-S	1030111

	Brief description	Type	part no.
connectors and cables			
	<ul style="list-style-type: none"> Description: HIPERFACE®, shielded, SSI, Incremental Connection type head A: Female connector, M23, 12-pin, straight, A-coded Signal type: HIPERFACE®, SSI, Incremental Connection systems: Solder connection 	DOS-2312-G	6027538
	<ul style="list-style-type: none"> Description: HIPERFACE®, shielded, SSI, Incremental, RS-422 Connection type head A: Male connector, M23, 12-pin, straight, A-coded Signal type: HIPERFACE®, SSI, Incremental, RS-422 Connection systems: Solder connection 	STE-2312-G	6027537
	<ul style="list-style-type: none"> Description: HIPERFACE®, shielded, SSI, Incremental Connection type head A: Female connector, M23, 9-pin, straight, A-coded Signal type: HIPERFACE®, SSI, Incremental Connection systems: Solder connection 	DOS-2309-G	6028533
	<ul style="list-style-type: none"> Description: HIPERFACE®, shielded, SSI, Incremental Connection type head A: Female connector, M23, 12-pin, angled, A-coded Signal type: HIPERFACE®, SSI, Incremental Connection systems: Solder connection 	DOS-2312-W01	2072580
shaft adaptation			
	<ul style="list-style-type: none"> Product segment: Shaft adaptation Product: Collets Description: Collet for blind hollow shaft, shaft diameter 12 mm, outer diameter 15 mm 	SPZ-012-AD-A	2029179
	<ul style="list-style-type: none"> Product segment: Shaft adaptation Product: Collets Description: Collet for blind hollow shaft, shaft diameter 1/2" (12.7 mm), outer diameter 15 mm 	SPZ-1E2-AD-A	2029180
	<ul style="list-style-type: none"> Product segment: Shaft adaptation Product: Collets Description: Collet for blind hollow shaft, shaft diameter 6 mm, outer diameter 15 mm 	SPZ-006-AD-A	2029174
	<ul style="list-style-type: none"> Product segment: Shaft adaptation Product: Collets Description: Collet for blind hollow shaft, shaft diameter 1/4" (6.35 mm), outer diameter 15 mm 	SPZ-1E4-AD-A	2029175
	<ul style="list-style-type: none"> Product segment: Shaft adaptation Product: Collets Description: Collet for blind hollow shaft, shaft diameter 8 mm, outer diameter 15 mm 	SPZ-008-AD-A	2029176
	<ul style="list-style-type: none"> Product segment: Shaft adaptation Product: Collets Description: Collet for blind hollow shaft, shaft diameter 3/8" (9.525 mm), outer diameter 15 mm 	SPZ-3E8-AD-A	2029177
	<ul style="list-style-type: none"> Product segment: Shaft adaptation Product: Collets Description: Collet for blind hollow shaft, shaft diameter 10 mm, outer diameter 15 mm 	SPZ-010-AD-A	2029178
	<ul style="list-style-type: none"> Product segment: Shaft adaptation Product: Collets Description: Collet for blind hollow shaft, shaft diameter 14 mm, outer diameter 15 mm 	SPZ-014-AD-A	2048863

SICK AT A GLANCE

SICK is one of the leading manufacturers of intelligent sensors and sensor solutions for industrial applications. A unique range of products and services creates the perfect basis for controlling processes securely and efficiently, protecting individuals from accidents and preventing damage to the environment.

We have extensive experience in a wide range of industries and understand their processes and requirements. With intelligent sensors, we can deliver exactly what our customers need. In application centers in Europe, Asia and North America, system solutions are tested and optimized in accordance with customer specifications. All this makes us a reliable supplier and development partner.

Comprehensive services complete our offering: SICK LifeTime Services provide support throughout the machine life cycle and ensure safety and productivity.

For us, that is “Sensor Intelligence.”

WORLDWIDE PRESENCE:

Contacts and other locations –www.sick.com