



# PLG3-420F431

PLG

AUTOMATION LIGHT GRIDS

**SICK**  
Sensor Intelligence.



Illustration may differ



## Ordering information

Type	part no.
PLG3-420F431	1029132

Other models and accessories → [www.sick.com/PLG](http://www.sick.com/PLG)

## Detailed technical data

### Features

<b>Sensor principle</b>	Photoelectric retro-reflective sensor
<b>Minimum detectable object (MDO)</b>	35 mm <sup>1)</sup>
<b>Beam separation</b>	30 mm
<b>Number of beams</b>	15
<b>Detection height</b>	420 mm

<sup>1)</sup> See characteristic curve.

### Mechanics/electronics

<b>Wave length</b>	650 nm
<b>Supply voltage V<sub>s</sub></b>	DC 15 V ... 30 V <sup>1)</sup>
<b>Power consumption sender</b>	< 45 mA
<b>Ripple</b>	< 5 V <sub>pp</sub>
<b>Output current I<sub>max.</sub></b>	≤ 100 mA
<b>Output load, capacitive</b>	100 nF
<b>Output load, Inductive</b>	1 H
<b>Initialization time</b>	0.6 s
<b>Switching output</b>	PNP <sup>2)</sup>
<b>Output mode</b>	Q dark switching <sup>3)</sup>
<b>Current consumption job LED</b>	10 mA <sup>1)</sup>
<b>Dimensions (W x H x D)</b>	19.2 mm x 499.8 mm x 36.6 mm

<sup>1)</sup> Typical value.

<sup>2)</sup> Q.

<sup>3)</sup> Q = active, if at least one beam is interrupted, /Q = active, if all of the beams are free.

<b>Connection type</b>	Cable with M12 male connector, 4-pin, 280 mm
<b>Housing material</b>	Aluminum
<b>Display</b>	LED
<b>Enclosure rating</b>	IP54
<b>Circuit protection</b>	U <sub>V</sub> connections, reverse polarity protected Output Q short-circuit protected Interference pulse suppression
<b>Protection class</b>	III
<b>Weight</b>	500 g
<b>Front screen</b>	PMMA

<sup>1)</sup> Typical value.

<sup>2)</sup> Q.

<sup>3)</sup> Q = active, if at least one beam is interrupted, /Q = active, if all of the beams are free.

## Performance

<b>Maximum range</b>	2 m
<b>Minimum range</b>	≥ 110 mm
<b>Operating range</b>	1.3 m
<b>Response time</b>	< 80 ms <sup>1)</sup>

<sup>1)</sup> With resistive load.

## Ambient data

<b>Shock resistance</b>	10 g / DIN EN 60068-2-29 / 16 ms
<b>Vibration resistance</b>	5 g, 10 Hz ... 55 Hz (IEC 68-2-6)
<b>EMC</b>	EN 60947-5-2
<b>Ambient operating temperature</b>	-10 °C ... +55 °C
<b>Ambient temperature, storage</b>	-40 °C ... +70 °C

## Certificates

<b>EU declaration of conformity</b>	✓
<b>UK declaration of conformity</b>	✓
<b>ACMA declaration of conformity</b>	✓
<b>Moroccan declaration of conformity</b>	✓
<b>China RoHS</b>	✓
<b>Photobiological safety (IEC EN 62471)</b>	✓

## Classifications

<b>ECLASS 5.0</b>	27270910
<b>ECLASS 5.1.4</b>	27270910
<b>ECLASS 6.0</b>	27270910
<b>ECLASS 6.2</b>	27270910
<b>ECLASS 7.0</b>	27270910
<b>ECLASS 8.0</b>	27270910
<b>ECLASS 8.1</b>	27270910
<b>ECLASS 9.0</b>	27270910

<b>ECLASS 10.0</b>	27270910
<b>ECLASS 11.0</b>	27270910
<b>ECLASS 12.0</b>	27270910
<b>ETIM 5.0</b>	EC002549
<b>ETIM 6.0</b>	EC002549
<b>ETIM 7.0</b>	EC002549
<b>ETIM 8.0</b>	EC002549
<b>UNSPSC 16.0901</b>	39121528

Dimensional drawing PLG3

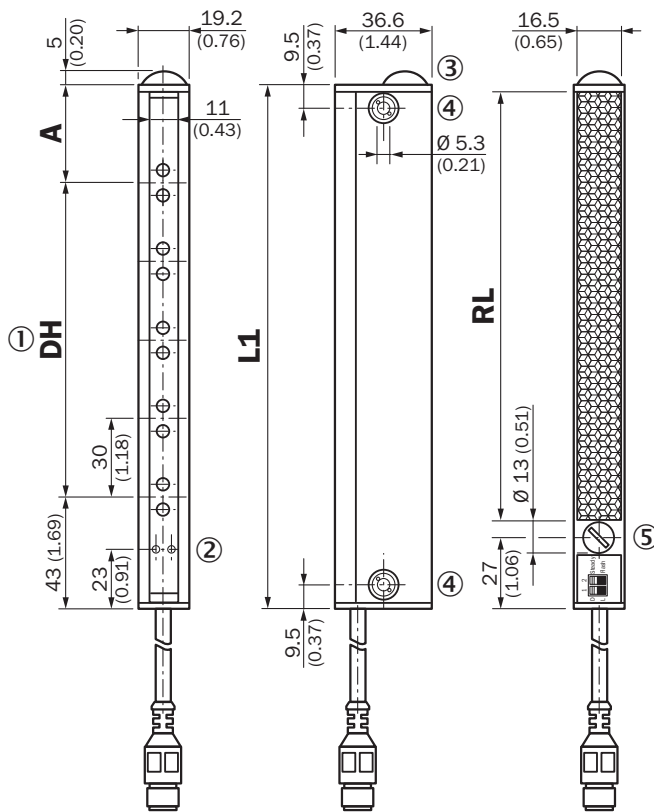

DH	A	L1	RL
<b>120 (4.72)</b>	36 (1.42)	199.8 (7.87)	162 (6.38)
<b>210 (8.27)</b>	26 (1.02)	279.8 (11.02)	242 (9.53)
<b>270 (10.63)</b>	36 (1.42)	349.8 (13.77)	312 (12.28)
<b>360 (14.17)</b>	26 (1.02)	429.8 (16.92)	392 (15.43)
<b>420 (16.54)</b>	36 (1.42)	499.8 (19.68)	462 (18.19)

Dimensions in mm (inch)

- ① Detection height (DH)
- ② Indicator Power on: green; beam status: yellow
- ③ job LED, green
- ④ Mounting hole, Ø 5.3 mm
- ⑤ Configuration switches

### Connection type and diagram

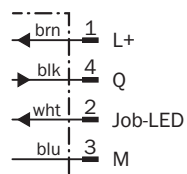
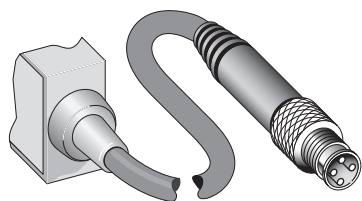

### Adjustments PLG3

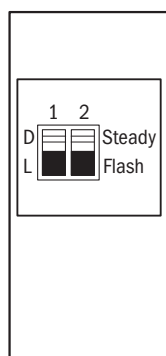

#### Configuration over switches

Switch 1	Switch 2	Job-LED
D	Steady	Job-LED steady
L	Flash	Job-LED flashes, 3 Hz

## Specific features

### Easy installation

#### 1. Easy mounting on to different profiles

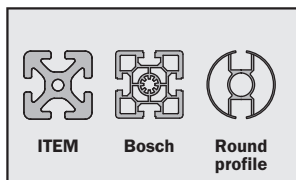

The light grid can be mounted on different profiles, e.g. ITEM, Bosch, round profile.

#### 2. Easy installation with slot nuts

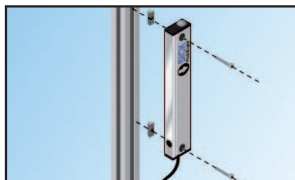

The PLG can easily be mounted on the profile with slot nuts.

### Plug & play

#### 1. Plug in and tighten the ring of the connector

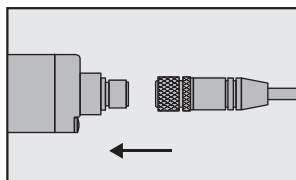

#### 2. Device is ready for use

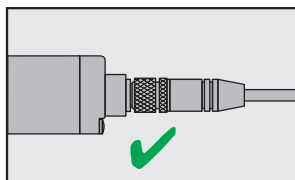

## Characteristic curve: range

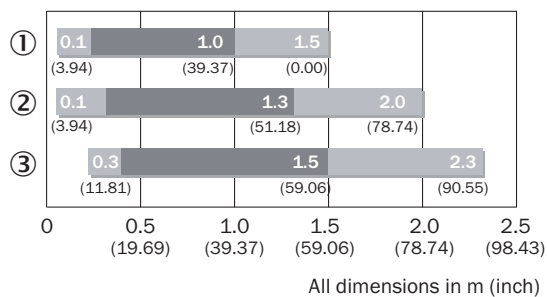

■ Working range ■ Min./max. range



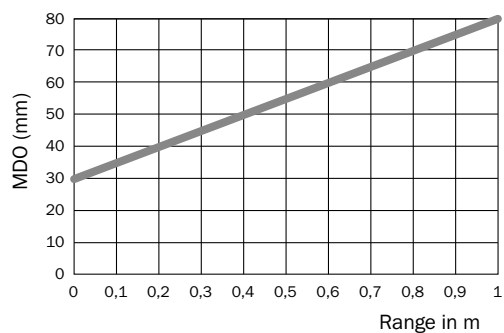

- ① REF-PLG
- ② Reflector PL150
- ③ Reflector PL180

## Detection capability PLG3



## Recommended accessories

Other models and accessories → [www.sick.com/PLG](http://www.sick.com/PLG)

	Brief description	Type	part no.
reflectors and optics			
	<ul style="list-style-type: none"> <li><b>Description:</b> Reflective tape on aluminium profile, 16.5 mm x 494.3 mm, 2 hole mounting</li> <li><b>Ambient operating temperature:</b> -25 °C ... +65 °C</li> </ul>	REF-PLG420	1029200
	<ul style="list-style-type: none"> <li><b>Description:</b> Self-adhesive, customizable length by roll</li> <li><b>Dimensions:</b> 2.5 cm 22.8 m</li> <li><b>Ambient operating temperature:</b> -20 °C ... +60 °C</li> </ul>	REF-PLUS-R25-K	4051184
Mounting systems			
	<ul style="list-style-type: none"> <li><b>Description:</b> Sliding nuts with spring metal ball for ITEM profile, 2x slot 6 and slot 8, including mounting material</li> <li><b>Items supplied:</b> Mounting hardware included with every 2 x slot 6 and slot 8</li> </ul>	BEF-NSIT-PLG	2041045
connectors and cables			
	<ul style="list-style-type: none"> <li><b>Description:</b> Sensor/actuator cable, unshielded</li> <li><b>Connection type head A:</b> Female connector, M12, 4-pin, straight, A-coded</li> <li><b>Connection type head B:</b> Flying leads</li> <li><b>Signal type:</b> Sensor/actuator cable</li> <li><b>Cable:</b> 5 m, 4-wire, PVC</li> <li><b>Application:</b> Untaminated zones, Zones with chemicals</li> </ul>	YF2A14-050VB3XLEAX	2096235

## SICK AT A GLANCE

SICK is one of the leading manufacturers of intelligent sensors and sensor solutions for industrial applications. A unique range of products and services creates the perfect basis for controlling processes securely and efficiently, protecting individuals from accidents and preventing damage to the environment.

We have extensive experience in a wide range of industries and understand their processes and requirements. With intelligent sensors, we can deliver exactly what our customers need. In application centers in Europe, Asia and North America, system solutions are tested and optimized in accordance with customer specifications. All this makes us a reliable supplier and development partner.

Comprehensive services complete our offering: SICK LifeTime Services provide support throughout the machine life cycle and ensure safety and productivity.

For us, that is “Sensor Intelligence.”

## WORLDWIDE PRESENCE:

Contacts and other locations –[www.sick.com](http://www.sick.com)