



# WL27-302610P01

W27

PHOTOELECTRIC SENSORS

**SICK**  
Sensor Intelligence.



Illustration may differ

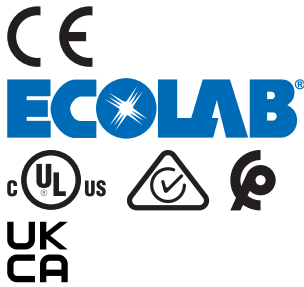

### Ordering information

Type	part no.
WL27-302610P01	1029113

Other models and accessories → [www.sick.com/W27](http://www.sick.com/W27)

### Detailed technical data

#### Features

<b>Functional principle</b>	Photoelectric retro-reflective sensor
<b>Functional principle detail</b>	With minimum distance to reflector (dual lens system)
<b>Dimensions (W x H x D)</b>	24.6 mm x 80.6 mm x 54 mm
<b>Housing design (light emission)</b>	Rectangular
<b>Sensing range max.</b>	0.1 m ... 2.5 m <sup>1)</sup>
<b>Sensing range</b>	0.1 m ... 2.5 m <sup>1)</sup>
<b>Focus</b>	Approx. 1.5°
<b>Type of light</b>	Infrared light
<b>Light source</b>	LED <sup>2)</sup>
<b>Light spot size (distance)</b>	Ø 250 mm (2.5 m)
<b>Angle of dispersion</b>	Approx. 1.5°
<b>Wave length</b>	880 nm
<b>Adjustment</b>	None
<b>Special features</b>	Premounted on bracket

<sup>1)</sup> TR27.

<sup>2)</sup> Average service life: 100,000 h at T<sub>J</sub> = +25 °C.

## Mechanics/electronics

<b>Supply voltage <math>U_B</math></b>	24 V DC ... 120 V DC <sup>1)</sup>
<b>Power consumption</b>	≤ 2.5 VA
<b>Switching output</b>	Relay <sup>2)</sup>
<b>Output function</b>	Change-over contacts
<b>Switching current (switching voltage)</b>	0.2 A (24 V DC)
<b>Response time</b>	≤ 10 ms <sup>3)</sup>
<b>Switching frequency</b>	10 Hz <sup>4)</sup>
<b>Connection type</b>	Male connector Q6, 6-pin, AC/UC-coded
<b>Circuit protection</b>	A <sup>5)</sup> C <sup>6)</sup>
<b>Protection class</b>	II <sup>7)</sup>
<b>Weight</b>	120 g
<b>Special device</b>	✓
<b>Housing material</b>	Plastic, ABS
<b>Optics material</b>	Plastic, PMMA
<b>Enclosure rating</b>	IP65
<b>Usage category</b>	DC-21 According to EN 60947-1
<b>Ambient operating temperature</b>	-40 °C ... +60 °C
<b>Ambient temperature, storage</b>	-40 °C ... +75 °C
<b>UL File No.</b>	NRKH.E181493 & NRKH7.E181493

1) +/- 10 %.

2) Provide suitable spark suppression for inductive or capacitive loads.

3) Signal transit time with resistive load.

4) With light/dark ratio 1:1.

5) A =  $V_S$  connections reverse-polarity protected.

6) C = interference suppression.

7) Reference voltage: 50 V DC.

## Certificates

<b>EU declaration of conformity</b>	✓
<b>UK declaration of conformity</b>	✓
<b>ACMA declaration of conformity</b>	✓
<b>Moroccan declaration of conformity</b>	✓
<b>China RoHS</b>	✓
<b>ECOLAB certificate</b>	✓
<b>cULus certificate</b>	✓
<b>Photobiological safety (DIN EN 62471) certificate</b>	✓

## Classifications

<b>ECLASS 5.0</b>	27270902
<b>ECLASS 5.1.4</b>	27270902
<b>ECLASS 6.0</b>	27270902

<b>ECLASS 6.2</b>	27270902
<b>ECLASS 7.0</b>	27270902
<b>ECLASS 8.0</b>	27270902
<b>ECLASS 8.1</b>	27270902
<b>ECLASS 9.0</b>	27270902
<b>ECLASS 10.0</b>	27270902
<b>ECLASS 11.0</b>	27270902
<b>ECLASS 12.0</b>	27270902
<b>ETIM 5.0</b>	EC002717
<b>ETIM 6.0</b>	EC002717
<b>ETIM 7.0</b>	EC002717
<b>ETIM 8.0</b>	EC002717
<b>UNSPSC 16.0901</b>	39121528

### Connection type

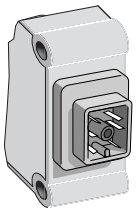

### Connection diagram Cd-184

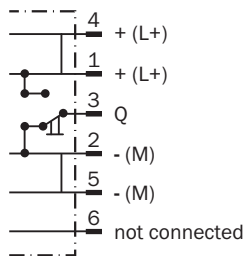

### Characteristic curve WL27-3

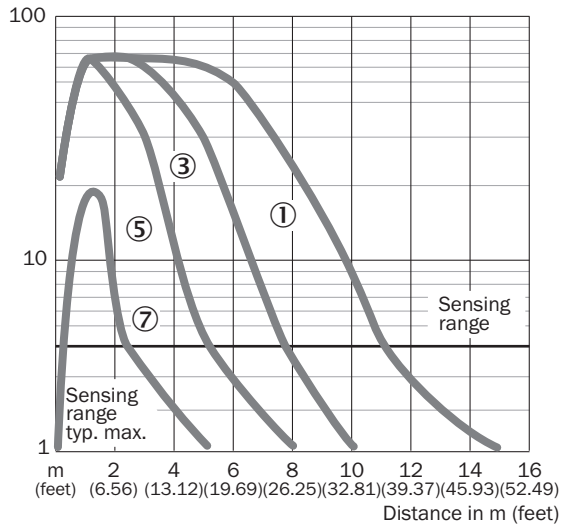

- ① Reflector PL80A
- ③ Reflector PL40A
- ⑤ Reflector PL20A
- ⑦ Reflective tape Diamond Grade

### Sensing range diagram WL27-3

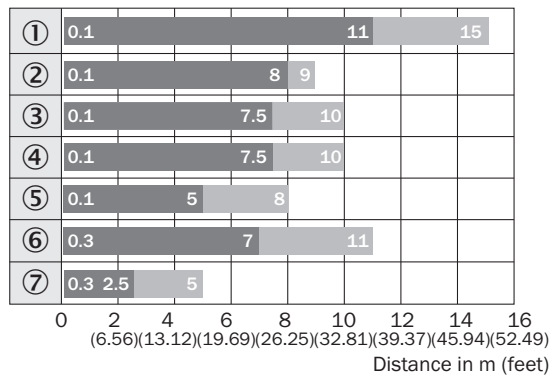

- Sensing range
- Sensing range max.
- ① Reflector PL80A
- ② Reflector PL50A
- ③ Reflector PL40A
- ④ Reflector PL30A
- ⑤ Reflector PL20A
- ⑥ Reflector C110A
- ⑦ Reflective tape Diamond Grade

### Dimensional drawing WL27-3, WSE27-3

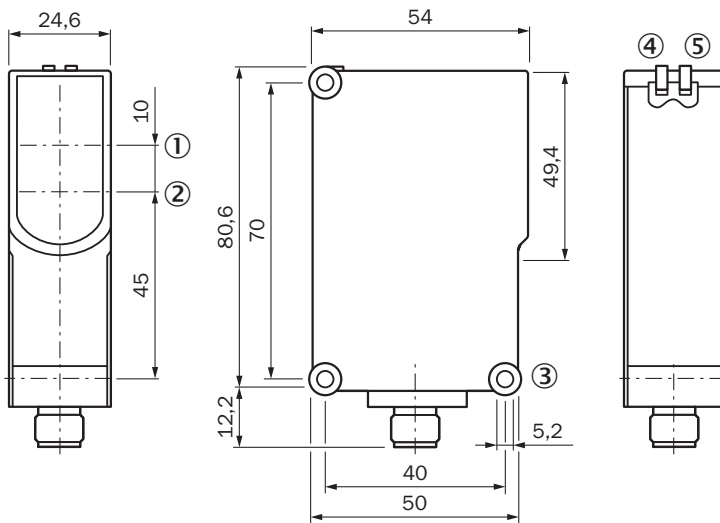





Dimensions in mm (inch)

- ① Optical axis, sender
- ② Optical axis, receiver
- ③ Mounting hole  $\varnothing$  5.2 mm
- ④ LED indicator green: Supply voltage active
- ⑤ LED indicator yellow: Status of received light beam

### Recommended accessories

Other models and accessories → [www.sick.com/W27](http://www.sick.com/W27)

	Brief description	Type	part no.
connectors and cables			
	<ul style="list-style-type: none"> <li>• <b>Description:</b> Sensor/actuator cable, unshielded</li> <li>• <b>Connection type head A:</b> Female connector, 6-pin, angled, AC/UC-coded</li> <li>• <b>Connection type head B:</b> Flying leads</li> <li>• <b>Signal type:</b> Sensor/actuator cable</li> <li>• <b>Cable:</b> 2 m, PVC</li> </ul>	DOL-1406-W02M	6030221
Mounting systems			
	<ul style="list-style-type: none"> <li>• <b>Description:</b> Mounting bracket with hinged arm</li> <li>• <b>Material:</b> Steel</li> <li>• <b>Details:</b> Steel, zinc coated</li> <li>• <b>Items supplied:</b> Mounting hardware included</li> <li>• <b>Suitable for:</b> W23-2, W27-3, Reflex Array</li> </ul>	BEF-WN-W27	2009122
	<ul style="list-style-type: none"> <li>• <b>Description:</b> Universal mounting bracket for reflectors</li> <li>• <b>Dimensions (W x H x L):</b> 85 mm x 90 mm x 35 mm</li> <li>• <b>Material:</b> Steel</li> <li>• <b>Details:</b> Steel, zinc coated</li> <li>• <b>Suitable for:</b> C110A, P250, PL20, PL30A, PL40A, PL80A</li> </ul>	BEF-WN-REFX	2064574

	Brief description	Type	part no.
device protection and care			
	<ul style="list-style-type: none"> <li>• <b>Description:</b> Protective housing for W26, W27-3 and mounting rods with diameter 12 mm ... 20 mm</li> <li>• <b>Material:</b> Steel, zinc diecast</li> <li>• <b>Items supplied:</b> Universal clamp BEF-KHS-KH1 (2022726), mounting hardware</li> <li>• <b>Suitable for:</b> W27-3, W26, RAY26</li> </ul>	BEF-SG-W27	2039601
reflectors and optics			
	<ul style="list-style-type: none"> <li>• <b>Description:</b> Rectangular, screw connection</li> <li>• <b>Dimensions:</b> 84 mm 84 mm</li> <li>• <b>Ambient operating temperature:</b> -30 °C ... +65 °C</li> </ul>	PL80A	1003865

## SICK AT A GLANCE

SICK is one of the leading manufacturers of intelligent sensors and sensor solutions for industrial applications. A unique range of products and services creates the perfect basis for controlling processes securely and efficiently, protecting individuals from accidents and preventing damage to the environment.

We have extensive experience in a wide range of industries and understand their processes and requirements. With intelligent sensors, we can deliver exactly what our customers need. In application centers in Europe, Asia and North America, system solutions are tested and optimized in accordance with customer specifications. All this makes us a reliable supplier and development partner.

Comprehensive services complete our offering: SICK LifeTime Services provide support throughout the machine life cycle and ensure safety and productivity.

For us, that is “Sensor Intelligence.”

## WORLDWIDE PRESENCE:

Contacts and other locations –[www.sick.com](http://www.sick.com)