



# WLG4-3F2234

W4

PHOTOELECTRIC SENSORS

**SICK**  
Sensor Intelligence.



Illustration may differ



### Ordering information

Type	part no.
WLG4-3F2234	1028130

Other models and accessories → [www.sick.com/W4](http://www.sick.com/W4)

### Detailed technical data

#### Features

<b>Functional principle</b>	Photoelectric retro-reflective sensor
<b>Sensing range max.</b>	0.01 m ... 4.5 m <sup>1)</sup>
<b>Sensing range</b>	0.02 m ... 3.5 m <sup>1)</sup>
<b>Polarisation filter</b>	Yes
<b>Emitted beam</b>	
Light source	PinPoint LED <sup>2)</sup>
Type of light	Visible red light
Light spot size (distance)	Ø 75 mm (1.5 m)
<b>Key LED figures</b>	
Wave length	650 nm
<b>Adjustment</b>	Cable, Single teach-in button
<b>Special applications</b>	Detecting transparent objects
<b>AutoAdapt</b>	✓

<sup>1)</sup> Reflector PL80A.

<sup>2)</sup> Average service life: 100,000 h at T<sub>J</sub> = +25 °C.

## Electronics

<b>Supply voltage <math>U_B</math></b>	10 V DC ... 30 V DC <sup>1)</sup>
<b>Ripple</b>	< 5 V <sub>pp</sub> <sup>2)</sup>
<b>Current consumption</b>	20 mA <sup>3)</sup>
<b>Protection class</b>	III
<b>Digital output</b>	
Type	PNP
Switching mode	Dark switching
Output current I <sub>max.</sub>	≤ 100 mA
Response time	< 0.5 ms <sup>4)</sup>
Switching frequency	1,000 Hz <sup>5)</sup>
<b>Attenuation along light beam</b>	> 8 %
<b>Circuit protection</b>	A <sup>6)</sup> C <sup>7)</sup> D <sup>8)</sup>

<sup>1)</sup> Limit values.

<sup>2)</sup> May not fall below or exceed U<sub>y</sub> tolerances.

<sup>3)</sup> Without load.

<sup>4)</sup> Signal transit time with resistive load.

<sup>5)</sup> With light/dark ratio 1:1.

<sup>6)</sup> A = V<sub>S</sub> connections reverse-polarity protected.

<sup>7)</sup> C = interference suppression.

<sup>8)</sup> D = outputs overcurrent and short-circuit protected.

## Mechanics

<b>Housing</b>	Rectangular
<b>Design detail</b>	Flat
<b>Dimensions (W x H x D)</b>	16 mm x 39.5 mm x 12 mm
<b>Connection</b>	Male connector M8, 4-pin
<b>Material</b>	
Housing	Plastic, ABS
Front screen	Plastic, PMMA
<b>Weight</b>	30 g

## Ambient data

<b>Enclosure rating</b>	IP67 IP66
<b>Ambient operating temperature</b>	-40 °C ... +60 °C
<b>Ambient temperature, storage</b>	-40 °C ... +75 °C

## Certificates

<b>EU declaration of conformity</b>	✓
<b>UK declaration of conformity</b>	✓
<b>ACMA declaration of conformity</b>	✓
<b>Moroccan declaration of conformity</b>	✓
<b>China RoHS</b>	✓

<b>ECOLAB certificate</b>	✓
<b>Photobiological safety (DIN EN 62471) certificate</b>	✓

Classifications

<b>ECLASS 5.0</b>	27270902
<b>ECLASS 5.1.4</b>	27270902
<b>ECLASS 6.0</b>	27270902
<b>ECLASS 6.2</b>	27270902
<b>ECLASS 7.0</b>	27270902
<b>ECLASS 8.0</b>	27270902
<b>ECLASS 8.1</b>	27270902
<b>ECLASS 9.0</b>	27270902
<b>ECLASS 10.0</b>	27270902
<b>ECLASS 11.0</b>	27270902
<b>ECLASS 12.0</b>	27270902
<b>ETIM 5.0</b>	EC002717
<b>ETIM 6.0</b>	EC002717
<b>ETIM 7.0</b>	EC002717
<b>ETIM 8.0</b>	EC002717
<b>UNSPSC 16.0901</b>	39121528

Connection type

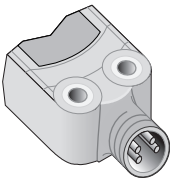

Connection diagram Cd-092

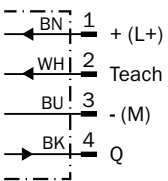

### Characteristic curve WLG4-3 with polarisation filter

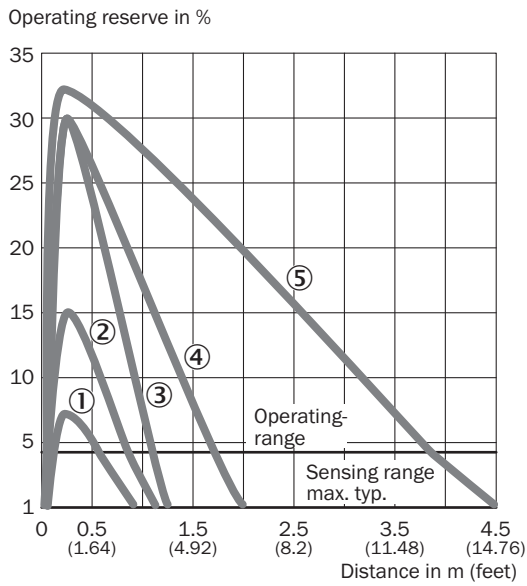

- ① Reflective tape REF-IRF-56
- ② PL10F reflector
- ③ Reflector PL20A
- ④ Reflector PL40A
- ⑤ Reflector PL80A

### Sensing range diagram WLG4-3 with polarisation filter

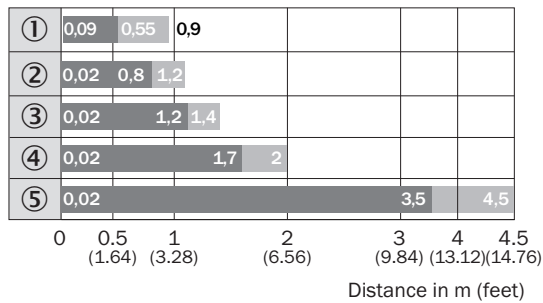

- Sensing range
- Sensing range max.
- ① Reflective tape REF-IRF-56
- ② PL10F reflector
- ③ Reflector PL20A
- ④ Reflector PL40A
- ⑤ Reflector PL80A

Modified teach mode

**Geänderter Teach Modus**  
**modified teach mode**  
**WLG4-3**

---

Bitte neuen Teach-In-Mode ab Herstellungswoche  
**01/2013** berücksichtigen.

Teach-In-Taste drücken:

- **2 Sek.** für transparente Objekte (8% Schaltschwelle mit autom. Nachführung)
- **8 Sek.** für Standardanwendungen (Schaltschwelle 50%)

Teach-In-Mode **vor** Herstellungswoche **01/2013**

Teach-In-Taste drücken:

- **2 Sek.** (50% Schaltschwelle ohne Nachführung)
  - **8 Sek.** für transparente Objekte (Schaltschwelle 10%)
- 

Please consider new teach-in mode as of  
production week **01/2013**.

Press teach-in button:

- **2 sec.** for clear objects (8% threshold with continuous threshold adaption)
- **8 sec.** for standard mode (50% threshold)

Teach-In-Mode **before** production week **01/2013**.

Press teach-in button:

- **2 sec.** (50% threshold without continuous threshold adaption)
  - **8 sec.** for clear objects (threshold 10%)
- 

Bsp. Herstellungswoche 1309 = KW09/2013  
eg production week 1309 = CW09/2013



**SICK**  
Sensor Intelligence.

### Dimensional drawing WL4-3

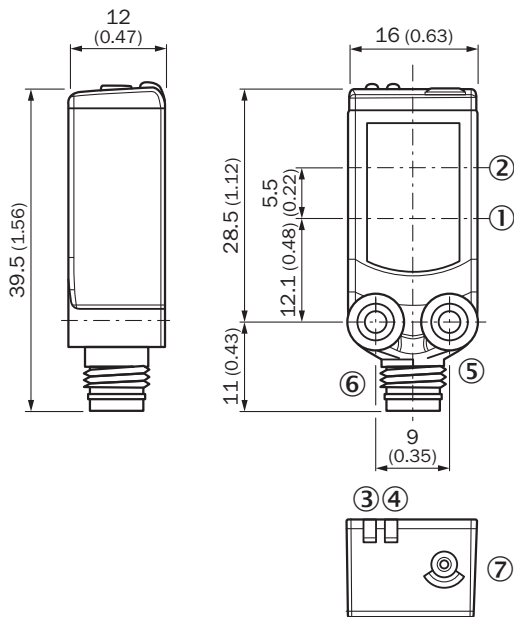







Dimensions in mm (inch)

- ① Center of optical axis, sender
- ② Center of optical axis, receiver
- ③ Orange LED indicator: status of received light beam
- ④ LED indicator green: Supply voltage active
- ⑤ Threaded mounting hole M3
- ⑥ Connection
- ⑦ Teach-in button

### Recommended accessories

Other models and accessories → [www.sick.com/W4](http://www.sick.com/W4)

	Brief description	Type	part no.
Mounting systems			
	<ul style="list-style-type: none"> <li>• <b>Description:</b> Universal mounting bracket for reflectors</li> <li>• <b>Dimensions (W x H x L):</b> 85 mm x 90 mm x 35 mm</li> <li>• <b>Material:</b> Steel</li> <li>• <b>Details:</b> Steel, zinc coated</li> <li>• <b>Suitable for:</b> C110A, P250, PL20, PL30A, PL40A, PL80A</li> </ul>	BEF-WN-REFX	2064574
	<ul style="list-style-type: none"> <li>• <b>Description:</b> Plate N08 for universal clamp bracket</li> <li>• <b>Material:</b> Steel, zinc diecast</li> <li>• <b>Details:</b> Zinc plated steel (sheet), Zinc die cast (clamping bracket)</li> <li>• <b>Items supplied:</b> Universal clamp (5322626), mounting hardware</li> <li>• <b>Usable for:</b> W100, W150, W4S, W4F, W8, W9-3, W8G, W8 Laser, W8 Inox, G6, W100 Laser, W100-2, W10, G6 Inox, RAY10, W4SLG-3, W9, GR18, MultiPulse, Reflex Array, MultiLine, LUT3, KT5, KT8, KT10, CS8</li> </ul>	BEF-KHS-N08	2051607

	Brief description	Type	part no.
reflectors and optics			
	<ul style="list-style-type: none"> <li>• <b>Description:</b> Fine triple reflector, screw connection, suitable for laser sensors</li> <li>• <b>Dimensions:</b> 52 mm 62 mm</li> <li>• <b>Ambient operating temperature:</b> -30 °C ... +65 °C</li> </ul>	P250F	5308843
connectors and cables			
	<ul style="list-style-type: none"> <li>• <b>Description:</b> Unshielded</li> <li>• <b>Connection type head A:</b> Male connector, M8, 4-pin, straight, A-coded</li> <li>• <b>Connection systems:</b> Screw-type terminals</li> <li>• <b>Permitted cross-section:</b> 0.14 mm² ... 0.5 mm²</li> </ul>	STE-0804-G	6037323
	<ul style="list-style-type: none"> <li>• <b>Description:</b> Sensor/actuator cable, unshielded</li> <li>• <b>Connection type head A:</b> Female connector, M8, 4-pin, straight, A-coded</li> <li>• <b>Connection type head B:</b> Flying leads</li> <li>• <b>Signal type:</b> Sensor/actuator cable</li> <li>• <b>Cable:</b> 5 m, 4-wire, PVC</li> <li>• <b>Application:</b> Uncontaminated zones, Zones with chemicals</li> </ul>	YF8U14-050VA3XLEAX	2095889
	<ul style="list-style-type: none"> <li>• <b>Description:</b> Sensor/actuator cable, unshielded</li> <li>• <b>Connection type head A:</b> Female connector, M8, 4-pin, straight, A-coded</li> <li>• <b>Connection type head B:</b> Flying leads</li> <li>• <b>Signal type:</b> Sensor/actuator cable</li> <li>• <b>Cable:</b> 5 m, 4-wire, PUR, halogen-free</li> <li>• <b>Application:</b> Drag chain operation, Zones with oils and lubricants, Robot, Drag chain operation</li> </ul>	YF8U14-050UA3XLEAX	2094792

## SICK AT A GLANCE

SICK is one of the leading manufacturers of intelligent sensors and sensor solutions for industrial applications. A unique range of products and services creates the perfect basis for controlling processes securely and efficiently, protecting individuals from accidents and preventing damage to the environment.

We have extensive experience in a wide range of industries and understand their processes and requirements. With intelligent sensors, we can deliver exactly what our customers need. In application centers in Europe, Asia and North America, system solutions are tested and optimized in accordance with customer specifications. All this makes us a reliable supplier and development partner.

Comprehensive services complete our offering: SICK LifeTime Services provide support throughout the machine life cycle and ensure safety and productivity.

For us, that is “Sensor Intelligence.”

## WORLDWIDE PRESENCE:

Contacts and other locations –[www.sick.com](http://www.sick.com)