



DATA SHEET

WS/WE12L-2N410A04

W12
Photoelectric sensors

SICK

Sensor Intelligence

PHOTOELECTRIC SENSORS

WS/
WE12L-2N410AO4

Illustration may differ

ORDERING INFORMATION

Type	part no.
WS/WE12L-2N410AO4	1023060

Further device versions and accessories at www.sick.com/W12

DETAILED TECHNICAL DATA

FEATURES

Functional principle	Through-beam photoelectric sensor	
Sensing range max.	0 m ... 80 m	
Emitted beam	Light source	Laser ¹⁾
	Type of light	Visible red light
	Light spot size (distance)	Ø 0.5 mm (1.5 m)
Key laser figures	Normative reference	EN 60825-1:2014, IEC 60825-1:2007
	Laser class	2 ^{2) 3)}
	Key LED figures	Wave length
Adjustment	None	
Special features	American version	
Special applications	Detecting small objects, Detection of objects moving at high speeds	
Part number of individual components	2021725 WE12L-2N430 2026588 WS12L-2D410AO4	

¹⁾ Average service life: 50,000 h at T_v = +25 °C.²⁾ Pulse length 4 µs, max. pulse power < 5,0 mW.³⁾ Do not intentionally look into the laser beam. Never point the laser beam at people's eyes.

SAFETY-RELATED PARAMETERS

MTTF _D	308 years
DC _{avg}	0 %

T_M (mission time)	10 years
----------------------	----------

ELECTRONICS

Supply voltage U_B	10 V DC ... 30 V DC ¹⁾														
Ripple	$< 5 V_{pp}$ ²⁾														
Current consumption, sender	$\leq 45 mA$ ³⁾														
Current consumption, receiver	$\leq 15 mA$ ³⁾														
Protection class	III														
Digital output	<table border="0"> <tr> <td>Type</td> <td>NPN</td> </tr> <tr> <td>Switching mode</td> <td>Light switching, Dark switching</td> </tr> <tr> <td>Signal voltage PNP HIGH/LOW</td> <td>$U_v - < 2.9 V, U_v V / 0 V \leq 1.5 V$</td> </tr> <tr> <td>Signal voltage NPN HIGH/LOW</td> <td>$U_v - < 2.9 V, U_v V / 0 V \leq 1.5 V$</td> </tr> <tr> <td>Output current I_{max}</td> <td>$\leq 100 mA$</td> </tr> <tr> <td>Response time</td> <td>$\leq 200 \mu s$ ⁴⁾</td> </tr> <tr> <td>Switching frequency</td> <td>2,500 Hz ⁵⁾</td> </tr> </table>	Type	NPN	Switching mode	Light switching, Dark switching	Signal voltage PNP HIGH/LOW	$U_v - < 2.9 V, U_v V / 0 V \leq 1.5 V$	Signal voltage NPN HIGH/LOW	$U_v - < 2.9 V, U_v V / 0 V \leq 1.5 V$	Output current I_{max}	$\leq 100 mA$	Response time	$\leq 200 \mu s$ ⁴⁾	Switching frequency	2,500 Hz ⁵⁾
Type	NPN														
Switching mode	Light switching, Dark switching														
Signal voltage PNP HIGH/LOW	$U_v - < 2.9 V, U_v V / 0 V \leq 1.5 V$														
Signal voltage NPN HIGH/LOW	$U_v - < 2.9 V, U_v V / 0 V \leq 1.5 V$														
Output current I_{max}	$\leq 100 mA$														
Response time	$\leq 200 \mu s$ ⁴⁾														
Switching frequency	2,500 Hz ⁵⁾														
Output function	Complementary														
Circuit protection	A ⁶⁾ C ⁷⁾ D ⁸⁾														

¹⁾ Limit values when operated in short-circuit protected network: max. 8 A.

²⁾ May not fall below or exceed U_B tolerances.

³⁾ Without load.

⁴⁾ Signal transit time with resistive load.

⁵⁾ With light/dark ratio 1:1.

⁶⁾ A = V_B connections reverse-polarity protected.

⁷⁾ C = interference suppression.

⁸⁾ D = outputs overcurrent and short-circuit protected.

MECHANICS

Housing	Rectangular				
Dimensions (W x H x D)	15 mm x 49 mm x 41.5 mm				
Connection	Male connector M12, 4-pin				
Material	<table border="0"> <tr> <td>Housing</td> <td>Metal</td> </tr> <tr> <td>Front screen</td> <td>Plastic, PMMA</td> </tr> </table>	Housing	Metal	Front screen	Plastic, PMMA
Housing	Metal				
Front screen	Plastic, PMMA				
Weight	260 g				

AMBIENT DATA

Enclosure rating	IP67 IP69K
Ambient operating temperature	-10 °C ... +50 °C
Ambient temperature, storage	-25 °C ... +75 °C

CERTIFICATES

EU declaration of conformity	✓
UK declaration of conformity	✓

ACMA declaration of conformity	✓
Moroccan declaration of conformity	✓
China RoHS	✓
cULus certificate	✓
Laser safety (IEC 60825-1) certificate	✓

DIMENSIONAL DRAWING WL12L-2, WS/WE12L-2

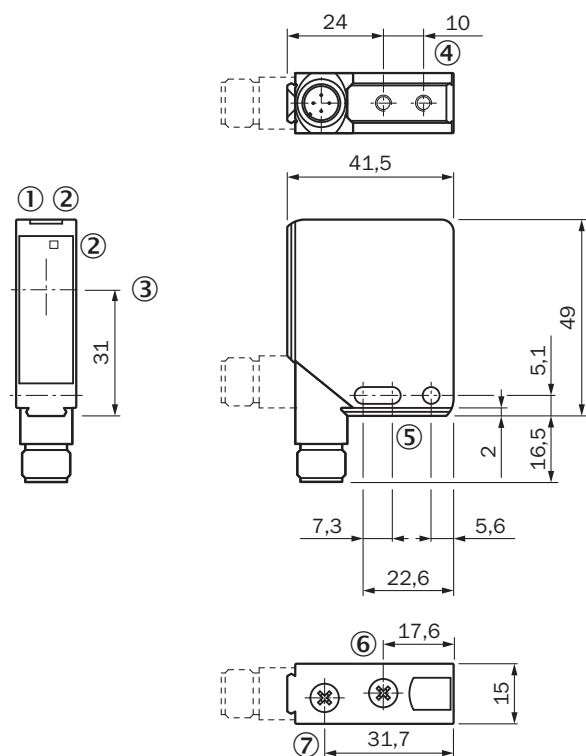

Dimensions in mm (inch)

- ① Operating indicator, green
- ② LED reception indicator, yellow
- ③ Center of optical axis
- ④ M4 threaded mounting hole - 4 mm depth
- ⑤ Mounting hole, Ø 4.2 mm
- ⑥ Focal adjustment
- ⑦ sensitivity control

ADJUSTMENTS WS/WE12L-2

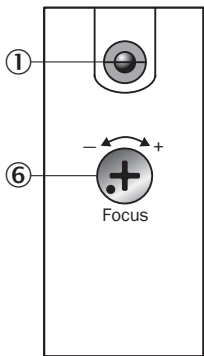

- ① status indicator (WS, top only)
- ⑥ Focal adjustment (WS)

ADJUSTMENTS

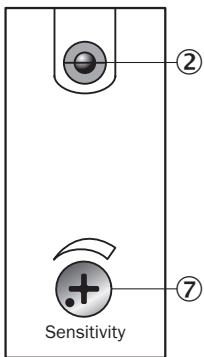

- ② LED signal strength indicator (WE)
- ⑦ Sensitivity adjustment (WE)

CONNECTION TYPE

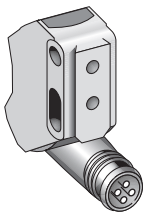

CONNECTION DIAGRAM CD-077

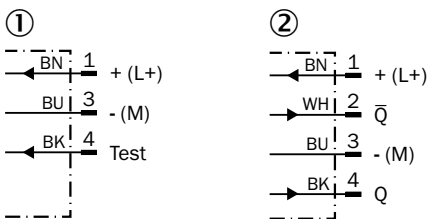

- ① sender
- ② receiver

CHARACTERISTIC CURVE WS/WE12L-2, 80 M

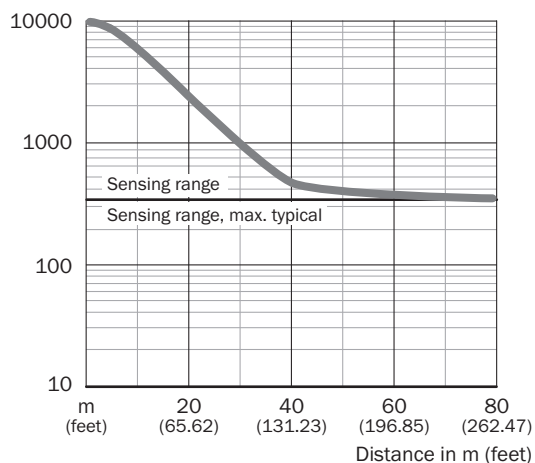

SENSING RANGE DIAGRAM WS/WE12L-2, 80 M

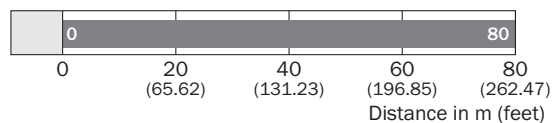

■ Sensing range/sensing range typ. max.

Further information as well as suitable accessories, example applications and downloads such as CAD dimensional models, operating instructions and software can be found at www.sick.com/1023060



SICK AG
WALDKIRCH
GERMANY
SICK.COM

SICK AT A GLANCE

SICK is a leading global technology company for intelligent sensors and integrated solutions in industrial automation. Our technologies set benchmarks, making your industrial processes more efficient, safer and more sustainable – both in logistics and manufacturing operations.

SICK combines sensor intelligence with industry expertise and certified consulting services. We provide the ideal foundation for scalable as well as tailor-made automation solutions and create added value along the entire value chain. Our close partnerships with our customers are more than just a promise: Together, we optimize productivity, improve quality, protect health and safety, and help build a sustainable future. All with empathy and trust.

Since 1946, we have been developing innovative technologies with passion and a pioneering spirit. With a global network in around 40 countries, SICK has a global presence and is always close by. The company's headquarters are located in Waldkirch near Freiburg, Germany. Our customers benefit from our understanding of both local and global requirements, which enables us to deliver tailor-made solutions

SICK
Sensor Intelligence