



WT12L-2B550A02

W12

PHOTOELECTRIC SENSORS

SICK
Sensor Intelligence.



Illustration may differ



Ordering information

Type	part no.
WT12L-2B550A02	1022048

Other models and accessories → www.sick.com/W12

Detailed technical data

Features

Functional principle	Photoelectric proximity sensor	
Functional principle detail	Background suppression	
Sensing range max.	50 mm ... 290 mm ¹⁾	
Emitted beam	Light source	Laser ²⁾
	Type of light	Visible red light
	Light spot size (distance)	Ø 0.3 mm (180 mm)
Focus position	100 mm	
Key laser figures	Normative reference	EN 60825-1:2014, IEC 60825-1:2007
	Laser class	2 ^{3) 4)}
Key LED figures	Wave length	650 nm
Adjustment	Potentiometer	
Special applications	Detecting small objects, Detection of objects moving at high speeds	

¹⁾ Object with 6% remission factor.

²⁾ Average service life: 50,000 h at T_U = +25 °C.

³⁾ Pulse length 4 µs, max. pulse power < 5,0 mW.

⁴⁾ Do not intentionally look into the laser beam. Never point the laser beam at people's eyes.

Safety-related parameters

MTTF_D	293 years
DC_{avg}	0 %
T_M (mission time)	10 years

Electronics

Supply voltage U_B	10 V DC ... 30 V DC ¹⁾
Ripple	< 5 V _{pp} ²⁾
Current consumption	55 mA ³⁾
Protection class	III
Digital output	
Type	PNP, NPN
Switching mode	Light/dark switching
Switching mode selector	Selectable via L/D control cable
Signal voltage PNP HIGH/LOW	$U_v - < 2 \text{ V}, U_v / 0 \text{ V}, \leq 1.5 \text{ V}$
Signal voltage NPN HIGH/LOW	$U_v - < 2 \text{ V}, U_v / 0 \text{ V}, \leq 1.5 \text{ V}$
Output current I_{max}	$\leq 100 \text{ mA}$
Response time	$\leq 200 \mu\text{s}$ ⁴⁾
Switching frequency	2,500 Hz ⁵⁾
Circuit protection	A ⁶⁾ C ⁷⁾ D ⁸⁾

¹⁾ Limit values when operated in short-circuit protected network: max. 8 A.

²⁾ May not fall below or exceed U_v tolerances.

³⁾ Without load.

⁴⁾ Signal transit time with resistive load.

⁵⁾ With light/dark ratio 1:1.

⁶⁾ A = V_S connections reverse-polarity protected.

⁷⁾ C = interference suppression.

⁸⁾ D = outputs overcurrent and short-circuit protected.

Mechanics

Housing	Rectangular
Dimensions (W x H x D)	15 mm x 49 mm x 41.5 mm
Connection	Plug, M12, 5-pin
Material	
Housing	Metal
Front screen	Plastic, PMMA
Weight	130 g

Ambient data

Enclosure rating	IP67
Ambient operating temperature	-10 °C ... +50 °C
Ambient temperature, storage	-25 °C ... +75 °C
UL File No.	American Version, 242362, 242361 (0312012-00)

Certificates

EU declaration of conformity	✓
UK declaration of conformity	✓
ACMA declaration of conformity	✓
Moroccan declaration of conformity	✓

China RoHS	✓
cULus certificate	✓
Laser safety (IEC 60825-1) certificate	✓

Classifications

ECLASS 5.0	27270904
ECLASS 5.1.4	27270904
ECLASS 6.0	27270904
ECLASS 6.2	27270904
ECLASS 7.0	27270904
ECLASS 8.0	27270904
ECLASS 8.1	27270904
ECLASS 9.0	27270904
ECLASS 10.0	27270904
ECLASS 11.0	27270904
ECLASS 12.0	27270903
ETIM 5.0	EC002719
ETIM 6.0	EC002719
ETIM 7.0	EC002719
ETIM 8.0	EC002719
UNSPSC 16.0901	39121528

Dimensional drawing WT12L-2

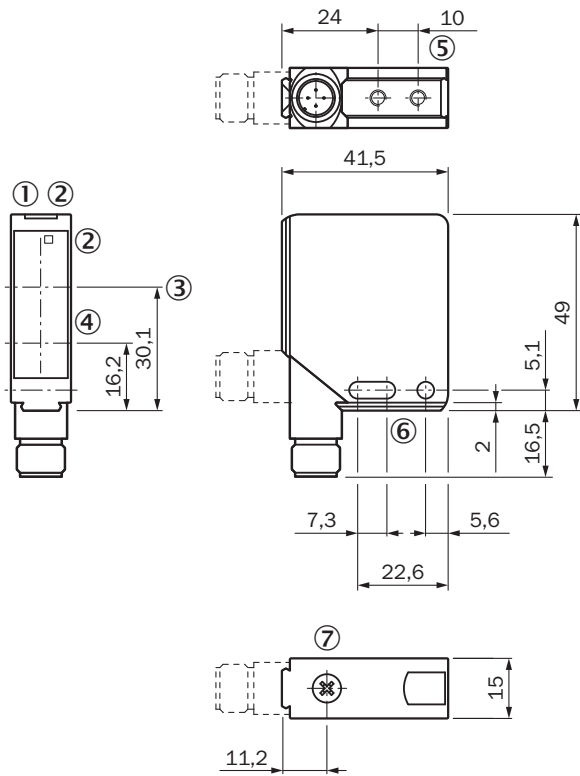

Dimensions in mm (inch)

- ① Operating indicator, green
- ② LED reception indicator, yellow
- ③ Optical axis, receiver
- ④ Optical axis, sender
- ⑤ M4 threaded mounting hole – 4 mm depth
- ⑥ Mounting hole, Ø 4.2 mm
- ⑦ Adjustment of sensing range

Adjustments WT12L-2

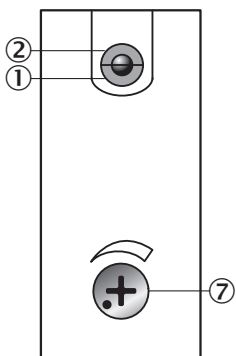

- ① Operating indicator, green
- ② LED reception indicator, yellow
- ⑦ Adjustment of sensing range

Connection type

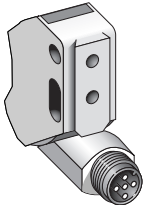

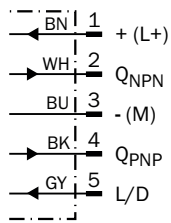

Connection diagram Cd-145



Recommended accessories

Other models and accessories → www.sick.com/W12

	Brief description	Type	part no.
Mounting systems			
	<ul style="list-style-type: none"> Description: Mounting bracket, large Material: Stainless steel Details: Stainless steel Items supplied: Mounting hardware included Suitable for: W11-2, W12-3, W16 	BEF-WG-W12	2013942
connectors and cables			
	<ul style="list-style-type: none"> Description: Sensor/actuator cable, unshielded Connection type head A: Female connector, M12, 5-pin, straight, A-coded Connection type head B: Flying leads Signal type: Sensor/actuator cable Cable: 5 m, 5-wire, PUR, halogen-free Application: Drag chain operation, Zones with oils and lubricants, Robot, Drag chain operation 	YF2A15-050UB5XLEAX	2095618
	<ul style="list-style-type: none"> Description: Sensor/actuator cable, unshielded Connection type head A: Female connector, M12, 5-pin, straight, A-coded Connection type head B: Flying leads Signal type: Sensor/actuator cable Cable: 5 m, 5-wire, PVC Application: Uncontaminated zones, Zones with chemicals 	YF2A15-050VB5XLEAX	2096240

SICK AT A GLANCE

SICK is one of the leading manufacturers of intelligent sensors and sensor solutions for industrial applications. A unique range of products and services creates the perfect basis for controlling processes securely and efficiently, protecting individuals from accidents and preventing damage to the environment.

We have extensive experience in a wide range of industries and understand their processes and requirements. With intelligent sensors, we can deliver exactly what our customers need. In application centers in Europe, Asia and North America, system solutions are tested and optimized in accordance with customer specifications. All this makes us a reliable supplier and development partner.

Comprehensive services complete our offering: SICK LifeTime Services provide support throughout the machine life cycle and ensure safety and productivity.

For us, that is “Sensor Intelligence.”

WORLDWIDE PRESENCE:

Contacts and other locations –www.sick.com