



PNS75-094

Mirror

REFLECTORS AND OPTICS

SICK
Sensor Intelligence.



Ordering information

Type	part no.
PNS75-094	1019418

Other models and accessories → www.sick.com/Mirror

Detailed technical data

Classifications

ECLASS 5.0	27279207
ECLASS 5.1.4	27279207
ECLASS 6.0	27279207
ECLASS 6.2	27279207
ECLASS 7.0	27279207
ECLASS 8.0	27279207
ECLASS 8.1	27279207
ECLASS 9.0	27273605
ECLASS 10.0	27273605
ECLASS 11.0	27273605
ECLASS 12.0	27273605
ETIM 5.0	EC002467
ETIM 6.0	EC002467
ETIM 7.0	EC002467
ETIM 8.0	EC002467
UNSPSC 16.0901	39111827

Dimensional drawing PNS75

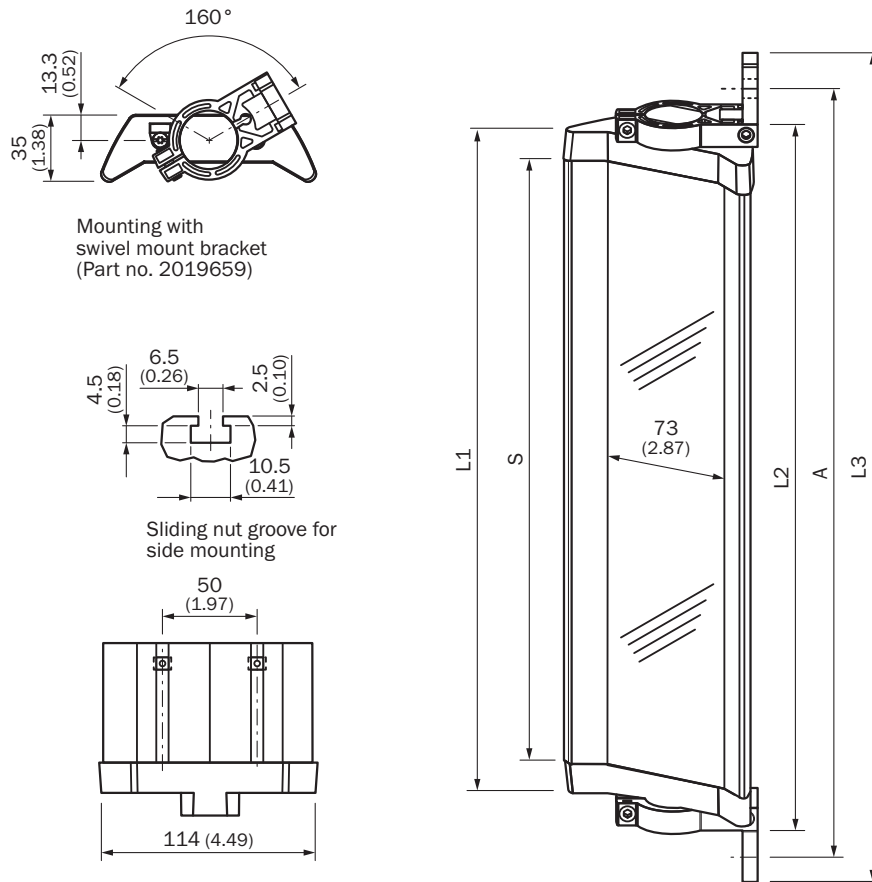

Dimensions in mm (inch)

	L1	L2	L3	A
340	372	396	460	440
490	522	546	610	590
640	672	696	760	740
790	822	846	910	890
940	972	996	1,060	1,040
1,090	1,122	1,146	1,210	1,190
1,240	1,272	1,296	1,360	1,340
1,390	1,422	1,446	1,510	1,490
1,540	1,572	1,596	1,660	1,640
1,690	1,722	1,746	1,810	1,790
1,840	1,872	1,896	1,960	1,940
1,990	2,022	2,046	2,110	2,090
2,140	2,172	2,196	2,260	2,240

SICK AT A GLANCE

SICK is one of the leading manufacturers of intelligent sensors and sensor solutions for industrial applications. A unique range of products and services creates the perfect basis for controlling processes securely and efficiently, protecting individuals from accidents and preventing damage to the environment.

We have extensive experience in a wide range of industries and understand their processes and requirements. With intelligent sensors, we can deliver exactly what our customers need. In application centers in Europe, Asia and North America, system solutions are tested and optimized in accordance with customer specifications. All this makes us a reliable supplier and development partner.

Comprehensive services complete our offering: SICK LifeTime Services provide support throughout the machine life cycle and ensure safety and productivity.

For us, that is “Sensor Intelligence.”

WORLDWIDE PRESENCE:

Contacts and other locations –www.sick.com