



WT12L-2B510

W12

PHOTOELECTRIC SENSORS

SICK
Sensor Intelligence.



Illustration may differ

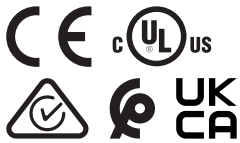

Ordering information

Type	part no.
WT12L-2B510	1017959

Included in delivery: BEF-KH-W12 (1)

Other models and accessories → www.sick.com/W12

Detailed technical data

Features

Functional principle	Photoelectric proximity sensor	
Functional principle detail	Background suppression	
Sensing range max.	20 mm ... 50 mm ¹⁾	
Emitted beam	Light source	Laser ²⁾
	Type of light	Visible red light
	Light spot size (distance)	Ø 0.1 mm (45 mm)
Focus position	45 mm	
Key laser figures	Normative reference	EN 60825-1:2014, IEC 60825-1:2007
	Laser class	2 ^{3) 4)}
Key LED figures	Wave length	650 nm
Adjustment	None	
Special applications	Detecting small objects, Detection of objects moving at high speeds	
Items supplied	2 x clamps BEF-KH-W12, incl. screws	

¹⁾ Object with 6% remission (based on standard white, DIN 5033).

²⁾ Average service life: 50,000 h at T_U = +25 °C.

³⁾ Pulse length 4 µs, max. pulse power < 5,0 mW.

⁴⁾ Do not intentionally look into the laser beam. Never point the laser beam at people's eyes.

Safety-related parameters

MTTF_D	293 years
DC_{avg}	0 %

Electronics

Supply voltage U_B	10 V DC ... 30 V DC ¹⁾	
Ripple	< 5 V _{pp} ²⁾	
Current consumption	55 mA ³⁾	
Protection class	III	
Digital output	Type	
	PNP ⁴⁾	
	NPN ⁵⁾	
	Switching mode	Light switching, Dark switching ^{4) 5)}
	Switching mode selector	Selectable via L/D control cable
	Signal voltage PNP HIGH/LOW	U _v - < 2 V, U _v / 0 V, <= 1.5 V
	Signal voltage NPN HIGH/LOW	U _v - < 2 V, U _v / 0 V, <= 1.5 V
Output current I _{max.}	≤ 100 mA	
Response time	≤ 200 μs ⁶⁾	
Switching frequency	2,500 Hz ⁷⁾	
Circuit protection	A ⁸⁾ C ⁹⁾ D ¹⁰⁾	

¹⁾ Limit values when operated in short-circuit protected network: max. 8 A.

²⁾ May not fall below or exceed U_y tolerances.

³⁾ Without load.

⁴⁾ 0 V or not connected, light switching.

⁵⁾ U_v, dark switching.

⁶⁾ Signal transit time with resistive load.

⁷⁾ With light/dark ratio 1:1.

⁸⁾ A = V_S connections reverse-polarity protected.

⁹⁾ C = interference suppression.

¹⁰⁾ D = outputs overcurrent and short-circuit protected.

Mechanics

Housing	Rectangular	
Dimensions (W x H x D)	15 mm x 49 mm x 41.5 mm	
Connection	Plug, M12, 5-pin	
Material	Housing	Metal
	Front screen	Plastic, PMMA
Weight	130 g	

Ambient data

Enclosure rating	IP67 IP69K
Ambient operating temperature	-10 °C ... +50 °C
Ambient temperature, storage	-25 °C ... +75 °C
UL File No.	NRKH.E181493 & NRKH7.E181493

Certificates

EU declaration of conformity	✓
UK declaration of conformity	✓
ACMA declaration of conformity	✓
Moroccan declaration of conformity	✓
China RoHS	✓
cULus certificate	✓
Laser safety (IEC 60825-1) certificate	✓

Classifications

ECLASS 5.0	27270904
ECLASS 5.1.4	27270904
ECLASS 6.0	27270904
ECLASS 6.2	27270904
ECLASS 7.0	27270904
ECLASS 8.0	27270904
ECLASS 8.1	27270904
ECLASS 9.0	27270904
ECLASS 10.0	27270904
ECLASS 11.0	27270904
ECLASS 12.0	27270903
ETIM 5.0	EC002719
ETIM 6.0	EC002719
ETIM 7.0	EC002719
ETIM 8.0	EC002719
UNSPSC 16.0901	39121528

Dimensional drawing

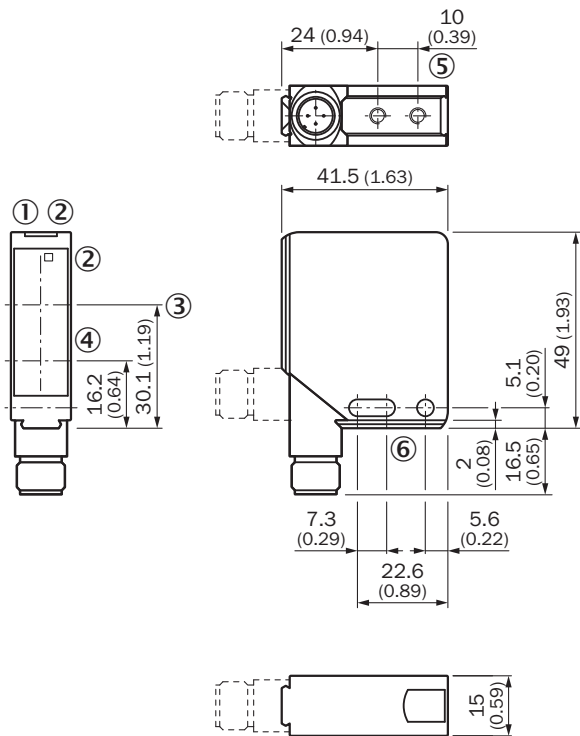

Dimensions in mm (inch)

- ① Operating indicator, green
- ② LED reception indicator, yellow
- ③ Optical axis, receiver
- ④ Optical axis, sender
- ⑤ M4 threaded mounting hole - 4 mm depth
- ⑥ Mounting hole, \varnothing 4.2 mm

Adjustments

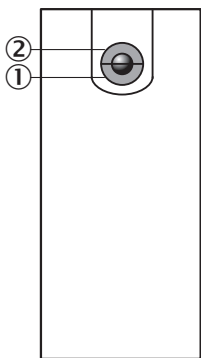

- ① Operating indicator, green
- ② LED reception indicator, yellow

Adjustments WT12L-2

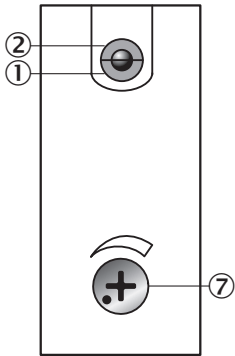

- ① Operating indicator, green
- ② LED reception indicator, yellow
- ⑦ Adjustment of sensing range

Connection type

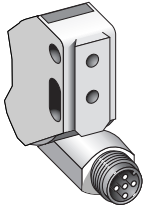

Connection diagram Cd-145

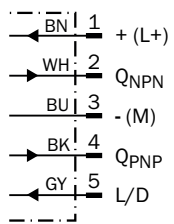

Characteristic curve

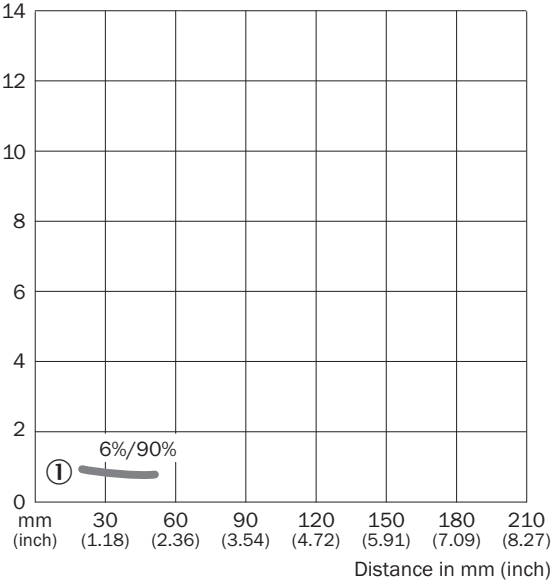

① Sensing range on black, 6 % remission, fix

Sensing range diagram

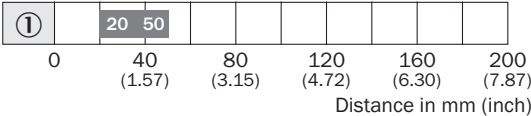



■ Sensing range

① Sensing range on black, 6 % remission, fix

Recommended accessories

Other models and accessories → www.sick.com/W12

	Brief description	Type	part no.
Mounting systems			
	<ul style="list-style-type: none"> • Description: Mounting bracket, large • Material: Stainless steel • Details: Stainless steel • Items supplied: Mounting hardware included • Suitable for: W11-2, W12-3, W16 	BEF-WG-W12	2013942

	Brief description	Type	part no.
connectors and cables			
	<ul style="list-style-type: none"> • Description: Sensor/actuator cable, unshielded • Connection type head A: Female connector, M12, 5-pin, straight, A-coded • Connection type head B: Flying leads • Signal type: Sensor/actuator cable • Cable: 5 m, 5-wire, PUR, halogen-free • Application: Drag chain operation, Zones with oils and lubricants, Robot, Drag chain operation 	YF2A15-050UB5XLEAX	2095618
	<ul style="list-style-type: none"> • Description: Sensor/actuator cable, unshielded • Connection type head A: Female connector, M12, 5-pin, straight, A-coded • Connection type head B: Flying leads • Signal type: Sensor/actuator cable • Cable: 5 m, 5-wire, PVC • Application: Uncontaminated zones, Zones with chemicals 	YF2A15-050VB5XLEAX	2096240

SICK AT A GLANCE

SICK is one of the leading manufacturers of intelligent sensors and sensor solutions for industrial applications. A unique range of products and services creates the perfect basis for controlling processes securely and efficiently, protecting individuals from accidents and preventing damage to the environment.

We have extensive experience in a wide range of industries and understand their processes and requirements. With intelligent sensors, we can deliver exactly what our customers need. In application centers in Europe, Asia and North America, system solutions are tested and optimized in accordance with customer specifications. All this makes us a reliable supplier and development partner.

Comprehensive services complete our offering: SICK LifeTime Services provide support throughout the machine life cycle and ensure safety and productivity.

For us, that is “Sensor Intelligence.”

WORLDWIDE PRESENCE:

Contacts and other locations –www.sick.com