



# LBV321-XTGCRAMX01500

LBV3xx

LEVEL SENSORS

**SICK**  
Sensor Intelligence.



### Ordering information

Type	part no.
LBV321-XXTGCRAMX01500	6074853

Other models and accessories → [www.sick.com/LBV3xx](http://www.sick.com/LBV3xx)

Illustration may differ



### Detailed technical data

#### Features

<b>Medium</b>	Bulk solids
<b>Measurement</b>	Switch
<b>Probe type</b>	Rod probe
<b>Probe length</b>	1,500 mm
<b>Process pressure</b>	-1 bar ... 6 bar
<b>Process temperature</b>	-20 °C ... +80 °C
<b>Fill material density</b>	≥ 0.02 g/cm <sup>3</sup>
<b>Tensile strength</b>	≤ 3,000 N

#### Performance

<b>Accuracy of sensor element</b>	± 10 mm
<b>Reproducibility</b>	≤ 5 mm
<b>Response time</b>	500 ms <sup>1)</sup> 100 ms <sup>2)</sup>
<b>MTBF</b>	4,17*10 <sup>6</sup> h

<sup>1)</sup> When covered.

<sup>2)</sup> When uncovered.

#### Electronics

<b>Communication interface</b>	-
<b>Supply voltage</b>	20 V DC ... 72 V DC 20 V AC ... 253 V AC
<b>Power consumption</b>	5 mA ... 30 mA
<b>Initialization time</b>	< 2 s
<b>VDE protection class 1</b>	✓
<b>Connection type</b>	M20 x 1.5
<b>Output signal</b>	Double relay (DPDT)
<b>Electronics</b>	Double relay (DPDT)
<b>Hysteresis</b>	10 mm
<b>Output current</b>	> 10 µA; < 3A AC, 1A DC

<b>Enclosure rating</b>	IP66 IP67
-------------------------	--------------

## Mechanics

<b>Wetted parts</b>	Stainless steel 1.4404 / 316L
<b>Process connection</b>	G 1, DIN 3852-A, PN 6 / 316L
<b>Housing material</b>	Aluminum
<b>Sensor material</b>	Stainless steel 316L, 318S, PUR, FEB

## Ambient data

<b>Ambient operating temperature</b>	-40 °C ... +70 °C
<b>Ambient temperature, storage</b>	-40 °C ... +80 °C

## Certificates

<b>EU declaration of conformity</b>	✓
<b>UK declaration of conformity</b>	✓
<b>ACMA declaration of conformity</b>	✓
<b>China RoHS</b>	✓

## Classifications

<b>ECLASS 5.0</b>	27273202
<b>ECLASS 5.1.4</b>	27273202
<b>ECLASS 6.0</b>	27273202
<b>ECLASS 6.2</b>	27273202
<b>ECLASS 7.0</b>	27273202
<b>ECLASS 8.0</b>	27273202
<b>ECLASS 8.1</b>	27273202
<b>ECLASS 9.0</b>	27273202
<b>ECLASS 10.0</b>	27273202
<b>ECLASS 11.0</b>	27273202
<b>ECLASS 12.0</b>	27273106
<b>ETIM 5.0</b>	EC002654
<b>ETIM 6.0</b>	EC002654
<b>ETIM 7.0</b>	EC002654
<b>ETIM 8.0</b>	EC002654
<b>UNSPSC 16.0901</b>	41111938

### Dimensional drawing LBV321 threaded version G 1 1/2 A

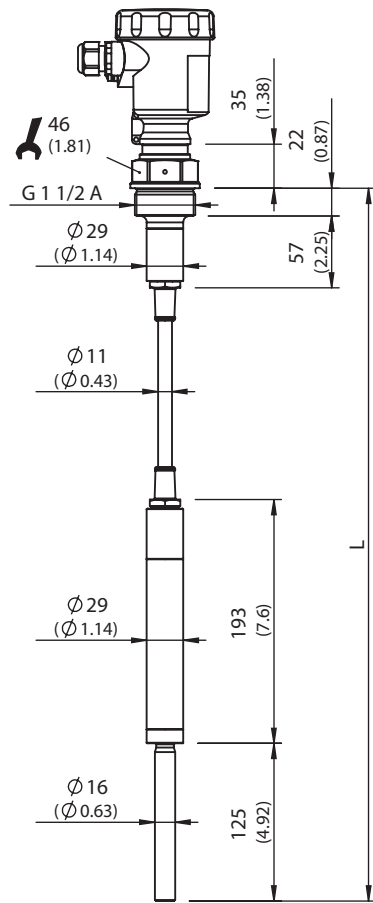

All dimensions in mm (inch)

Dimensions in mm (inch)

Dimensional drawing LBV321 threaded version G 1 A

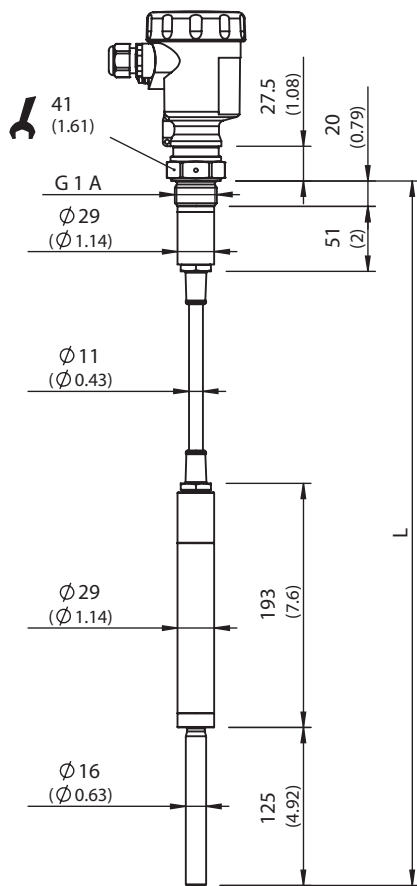

All dimensions in mm (inch)

Dimensions in mm (inch)

### Dimensional drawing Temperature adapter



Dimensions in mm (inch)

### Connection diagram Double relay connection diagram

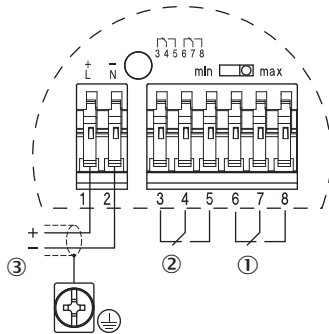

- ① Relay output
- ② Relay output
- ③ Power supply

Instruction for installation Flow orientation of the tuning fork



- ① Marking with screwed version
- ② Direction of flow

Instruction for installation Horizontal mounting



- ① Protective sheet
- ② Concave protective sheet for abrasive solids

Recommended accessories

Other models and accessories → [www.sick.com/LBV3xx](http://www.sick.com/LBV3xx)

	Brief description	Type	part no.
Mounting systems			
	<ul style="list-style-type: none"> <li>• <b>Description:</b> Locking screw connection, process pressure -1 bar to 16 bar, process connection G 2 A, inner thread G 1 1/2 A</li> <li>• <b>Material:</b> Stainless steel</li> <li>• <b>Details:</b> Stainless steel 316L</li> </ul>	BEF-MU-316G20-ALBV	5322462

## SICK AT A GLANCE

SICK is one of the leading manufacturers of intelligent sensors and sensor solutions for industrial applications. A unique range of products and services creates the perfect basis for controlling processes securely and efficiently, protecting individuals from accidents and preventing damage to the environment.

We have extensive experience in a wide range of industries and understand their processes and requirements. With intelligent sensors, we can deliver exactly what our customers need. In application centers in Europe, Asia and North America, system solutions are tested and optimized in accordance with customer specifications. All this makes us a reliable supplier and development partner.

Comprehensive services complete our offering: SICK LifeTime Services provide support throughout the machine life cycle and ensure safety and productivity.

For us, that is “Sensor Intelligence.”

## WORLDWIDE PRESENCE:

Contacts and other locations –[www.sick.com](http://www.sick.com)