



I2D305C-2RCA11

picoCam2

2D MACHINE VISION

SICK
Sensor Intelligence.



Ordering information

Type	part no.
I2D305C-2RCA11	6071826

Other models and accessories → www.sick.com/picoCam2



Detailed technical data

Features

Technology	2D snapshot
Streaming	✓
Image sensor	CMOS Color
Sensor used	Sony IMX264
Shutter technology	Global-Shutter
Illumination	To be ordered separately as accessories
Further functions	Line mode, region of interest, long exposure
Lens	C-mount
	Optical format 2/3"
	Note To be ordered separately as accessories
Task	Measuring - Dimension, contour and volume Monitoring and controlling - Quality Identifying - Pattern Identifying - Classifying Identifying - Sorting

Mechanics/electronics

Connection type	8-pin Hirose male connector
Supply voltage	12 V ... 24 V ¹⁾
Power consumption	≤ 3.1 W
Enclosure rating	IP30
Weight	52 g
Dimensions (L x W x H)	29 mm x 29 mm x 29 mm

¹⁾ Or PoE.

Performance

Bit depth	12 bit
Sensor properties	

	Sensor resolution	2,448 px x 2,048 px (5.01 MP)
	Pixel size	3.45 µm x 3.45 µm
	Sensor size	8.446 mm x 7.066 mm
Scan/frame rate		24 fps, in freerun mode
Memory		128 MB
Exposure time		0.035 ms ... 2,000 ms

Interfaces

Ethernet		✓, UDP/IP
	Remark	GigE Vision Standard
	Data transmission rate	1,000 Mbit/s
Configuration software		SICK Vision Suite

Ambient data

Shock load	80 g, EN 60068-2-27 (1995-03), EN 60068-2-29 (1995-03)
Vibration load	10 g, 30 Hz ... 500 Hz, EN 60068-2-6 (1996-05)
Ambient operating temperature	0 °C ... +55 °C ¹⁾
Storage temperature	-20 °C ... +60 °C ¹⁾

¹⁾ Relative humidity: 0% ... 100%.

General notes

Note	Not free of paint wetting impairment substances.
-------------	--

Certificates

EU declaration of conformity	✓
UK declaration of conformity	✓
ACMA declaration of conformity	✓
China RoHS	✓
Information according to Art. 3 of Data Act (Regulation EU 2023/2854)	✓
GigE Vision	✓

Classifications

ECLASS 5.0	27310205
ECLASS 5.1.4	27310205
ECLASS 6.0	27310205
ECLASS 6.2	27310205
ECLASS 7.0	27310205
ECLASS 8.0	27310205
ECLASS 8.1	27310205
ECLASS 9.0	27310205
ECLASS 10.0	27310205
ECLASS 11.0	27310205
ECLASS 12.0	27310205

ETIM 5.0	EC001820
ETIM 6.0	EC001820
ETIM 7.0	EC001820
ETIM 8.0	EC001820
UNSPSC 16.0901	43211731

Dimensional drawing

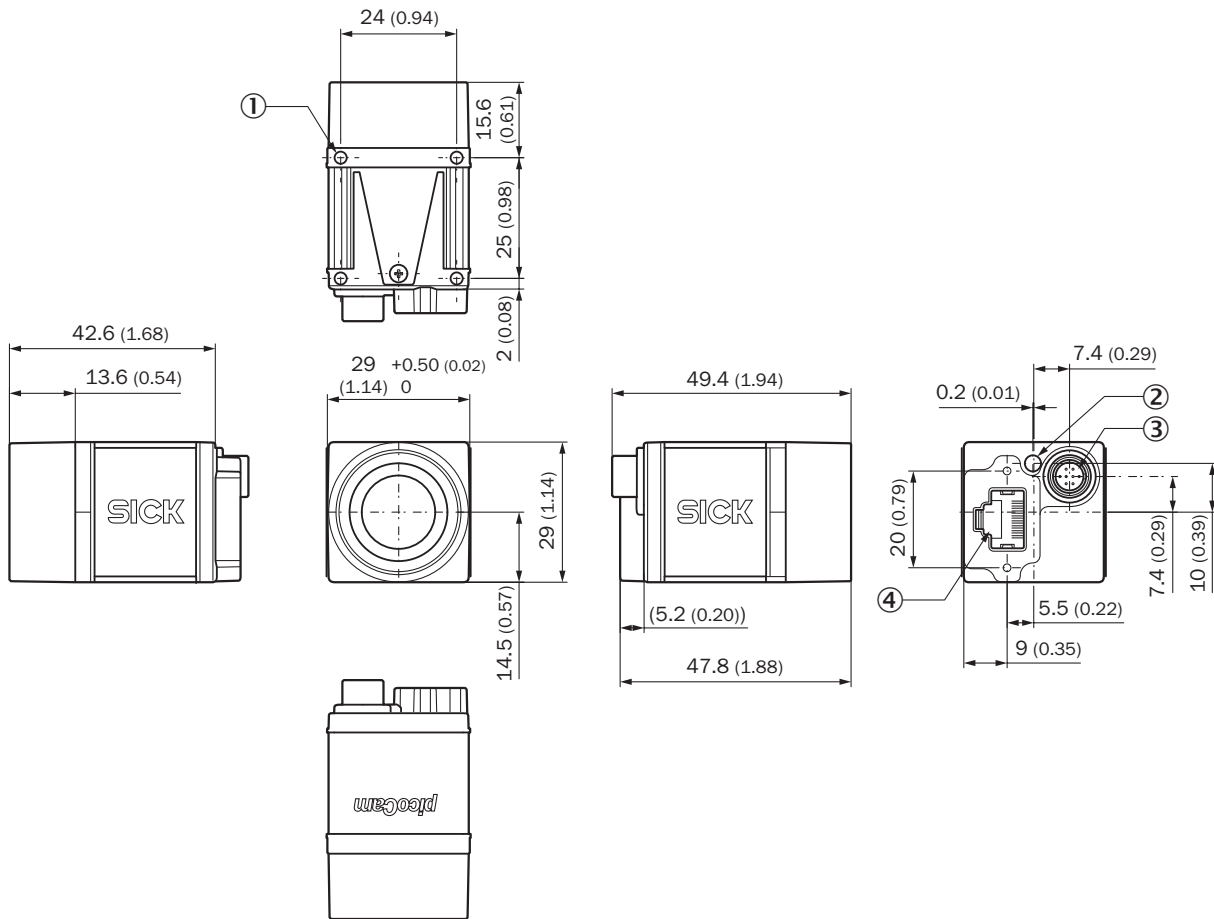

Dimensions in mm (inch)

- ① blind hole thread M3, 3 mm deep (4 x), for mounting
- ② LED for status display
- ③ Power I/O connection, male connector, 8-pin, Hirose HR25
- ④ Gigabit Ethernet port, RJ45, 8-pin

Field of view

Field of view y in mm (inch)

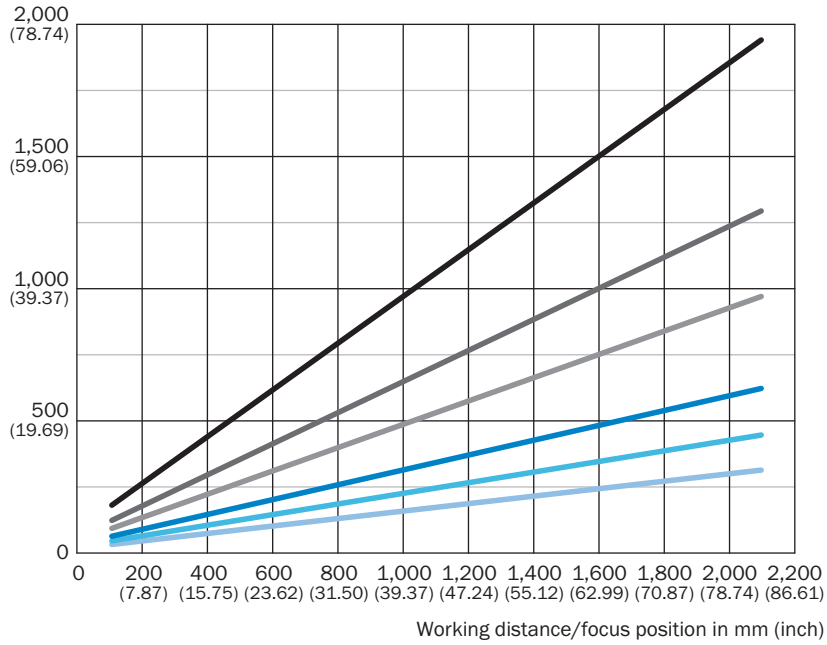

- f = 8 mm
- f = 12 mm
- f = 16 mm
- f = 25 mm
- f = 35 mm
- f = 50 mm

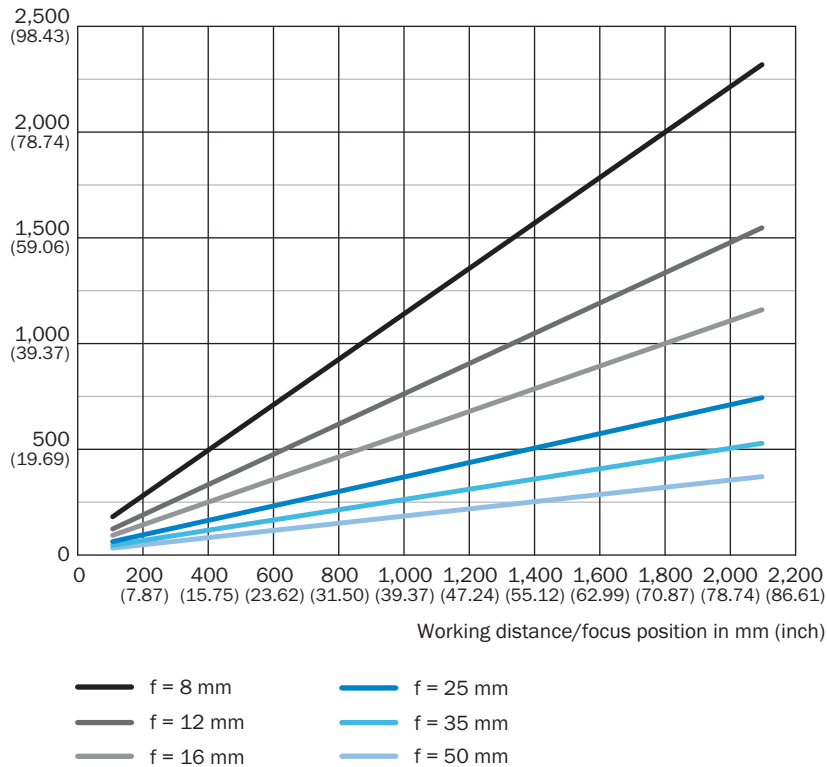

Field of view

Field of view x in mm (inch)



Recommended accessories

Other models and accessories → www.sick.com/picoCam2

	Brief description	Type	part no.
connectors and cables			
	<ul style="list-style-type: none"> Description: Power, shielded, Digital I/Os Connection type head A: Male connector, M12, 5-pin, A-coded Connection type head B: Female connector, Hirose HR25, 8-pin Signal type: Power, digital I/Os Cable: 1 m, PVC 	YM2Z15-010XXXFHRS8	2110626
	<ul style="list-style-type: none"> Description: Power, shielded, Digital I/Os Connection type head A: Male connector, M12, 5-pin, A-coded Connection type head B: Female connector, Hirose HR25, 8-pin Signal type: Power, digital I/Os Cable: 3 m, PVC 	YM2Z15-030XXXFHRS8	2110811
	<ul style="list-style-type: none"> Description: Power, shielded, Digital I/Os Connection type head A: Male connector, M12, 5-pin, A-coded Connection type head B: Female connector, Hirose HR25, 8-pin Signal type: Power, digital I/Os Cable: 5 m, PVC 	YM2Z15-050XXXFHRS8	2110812

SICK AT A GLANCE

SICK is one of the leading manufacturers of intelligent sensors and sensor solutions for industrial applications. A unique range of products and services creates the perfect basis for controlling processes securely and efficiently, protecting individuals from accidents and preventing damage to the environment.

We have extensive experience in a wide range of industries and understand their processes and requirements. With intelligent sensors, we can deliver exactly what our customers need. In application centers in Europe, Asia and North America, system solutions are tested and optimized in accordance with customer specifications. All this makes us a reliable supplier and development partner.

Comprehensive services complete our offering: SICK LifeTime Services provide support throughout the machine life cycle and ensure safety and productivity.

For us, that is “Sensor Intelligence.”

WORLDWIDE PRESENCE:

Contacts and other locations –www.sick.com