



# KTL180-ML4P41ZZZZZ

KTL180

CONTRAST SENSORS

**SICK**  
Sensor Intelligence.



Illustration may differ



### Ordering information

Type	part no.
KTL180-ML4P41ZZZZZ	6068617

Other models and accessories → [www.sick.com/KTL180](http://www.sick.com/KTL180)

### Detailed technical data

#### Features

<b>Parameter presettings</b>	None
<b>Special applications</b>	-
<b>Device type</b>	Base unit
<b>Housing design</b>	For fiber-optic
<b>Dimensions (W x H x D)</b>	10.5 mm x 33.2 mm x 71.9 mm
<b>Light source</b>	LED, White <sup>1)</sup>
<b>Wave length</b>	400 nm ... 750 nm
<b>Angle of dispersion</b>	Approx. 65° <sup>2)</sup>
<b>Sensing range</b>	0 mm ... 30 mm, Proximity system <sup>3)</sup>
<b>Sensing distance</b>	≤ 30 mm <sup>4)</sup>
<b>Display</b>	Display
<b>Display</b>	LED status display / 2x 4-character digital dual displays, Set value (green indicator) and actual value (red indicator) are displayed simultaneously, display of parameters
<b>Teach-in mode</b>	1-point teach-in, 2-point teach-in, teach-in dynamic
<b>Delay time</b>	Adjustable
<b>Special features</b>	Multi-function input, base unit for BUS mode
<b>Delivery status</b>	Teach-in dynamic
<b>Safety-related parameters</b>	
	MTTF <sub>D</sub> 300.4 years

<sup>1)</sup> Average service life: 100,000 h at T<sub>U</sub> = +25 °C.

<sup>2)</sup> See LL3 fiber-optic data.

<sup>3)</sup> Objects to be sensed with 90% reflectivity (based on DIN 5033 white standard). Sensing range depends on fiber-optic cable.

<sup>4)</sup> Depending on the optical fiber cable used.

## Electronics

<b>Supply voltage</b>	12 V DC ... 24 V DC <sup>1)</sup>
<b>Ripple</b>	≤ 10 % <sup>2)</sup>
<b>Current consumption</b>	≥ 50 mA (at 24 V)
<b>Switching frequency</b>	31.2 kHz
<b>Response time</b>	16 μs
<b>Jitter</b>	8 μs
<b>Number of switching outputs</b>	1
<b>Switching output</b>	NPN
<b>Switching mode</b>	Light/dark switching
<b>Output current I<sub>max.</sub></b>	100 mA <sup>3)</sup>
<b>Input, blanking input (AT)</b>	Blanked: U < 1 V: free-running: U = 1.5 V ... < U <sub>v</sub> <sup>4)</sup>
<b>Input, light/dark (L/D)</b>	Light: U = 1.5 V: light: U < 1 V <sup>4)</sup>
<b>Retention time (ET)</b>	25 ms, non-volatile memory
<b>Time delay</b>	None
<b>Protection class</b>	III
<b>Circuit protection</b>	U <sub>v</sub> connections, reverse polarity protected In-/outputs short-circuit protected Interference pulse suppression Outputs overcurrent and short-circuit protected
<b>Connection type</b>	Male connector M8, 4-pin

<sup>1)</sup> +/- 10%.

<sup>2)</sup> May not fall below or exceed U<sub>v</sub> tolerances.

<sup>3)</sup> Total current of all Outputs.

<sup>4)</sup> Minimum pulse 300 μs.

## Mechanics

<b>Housing material</b>	VISTAL®
<b>Weight</b>	25 g

## Ambient data

<b>Ambient operating temperature</b>	-25 °C ... +55 °C
<b>Ambient temperature, storage</b>	-40 °C ... +70 °C
<b>Shock load</b>	IEC 60068-2-27
<b>Enclosure rating</b>	IP50
<b>UL File No.</b>	EN 60947-5-2

## Certificates

<b>EU declaration of conformity</b>	✓
<b>UK declaration of conformity</b>	✓
<b>ACMA declaration of conformity</b>	✓
<b>Moroccan declaration of conformity</b>	✓
<b>China RoHS</b>	✓

<b>cULus certificate</b>	✓
<b>Photobiological safety (IEC EN 62471)</b>	✓
<b>Information according to Art. 3 of Data Act (Regulation EU 2023/2854)</b>	✓

### Classifications

<b>ECLASS 5.0</b>	27270906
<b>ECLASS 5.1.4</b>	27270906
<b>ECLASS 6.0</b>	27270906
<b>ECLASS 6.2</b>	27270906
<b>ECLASS 7.0</b>	27270906
<b>ECLASS 8.0</b>	27270906
<b>ECLASS 8.1</b>	27270906
<b>ECLASS 9.0</b>	27270906
<b>ECLASS 10.0</b>	27270906
<b>ECLASS 11.0</b>	27270906
<b>ECLASS 12.0</b>	27270906
<b>ETIM 5.0</b>	EC001820
<b>ETIM 6.0</b>	EC001820
<b>ETIM 7.0</b>	EC001820
<b>ETIM 8.0</b>	EC001820
<b>UNSPSC 16.0901</b>	39121528

### Dimensional drawing Bus type

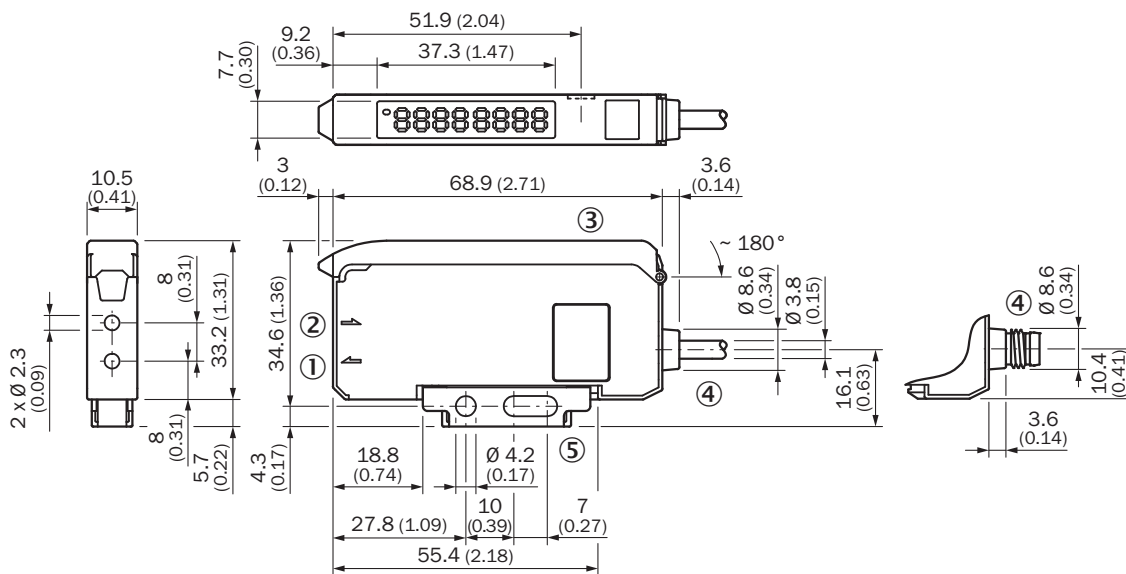

Dimensions in mm (inch)

- ① Sender LED, installation of LL3 fibre-optic cable (sender fibre)
- ② Receiver, installation of LL3 fibre optic cable (receiver fibre)
- ③ protective hood opens approx. 180°

- ④ Connection
- ⑤ Mounting bracket, included with delivery

### Adjustments

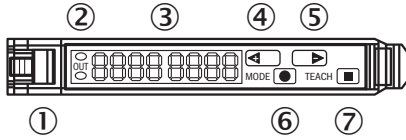

- ① Locking the fiber-optic cables
- ② LED indicator orange, lights up when switching output is active
- ③ Numeric display 2 x 4-digit; green: switching threshold, operating mode; red: actual value, Teach-in and function parameter
- ④ step pushbutton > (manual switching threshold: higher/next function parameter)
- ⑤ step pushbutton < (manual switching threshold: lower/previous function parameter)
- ⑥ Mode/Enter-button
- ⑦ Teach-in button

### Connection diagram Cd-380

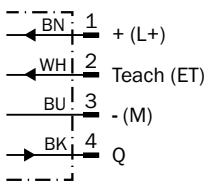

### Sensing distance LL3-DB01, LL3-DB04, LL3DM02

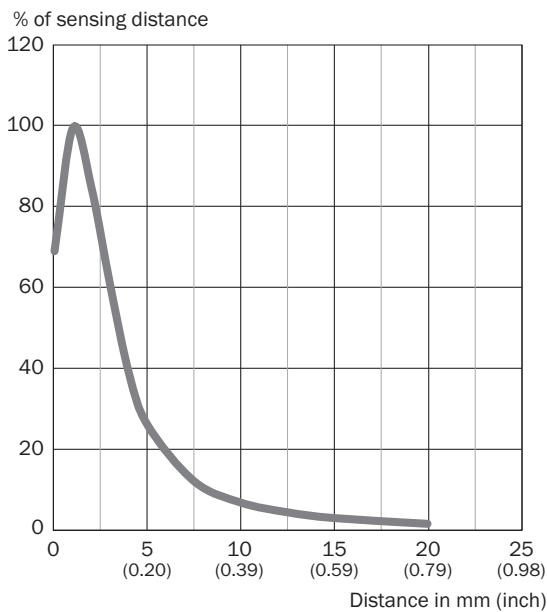

### Sensing distance LL3-DB09, LL3-DK04, LL3-DY01

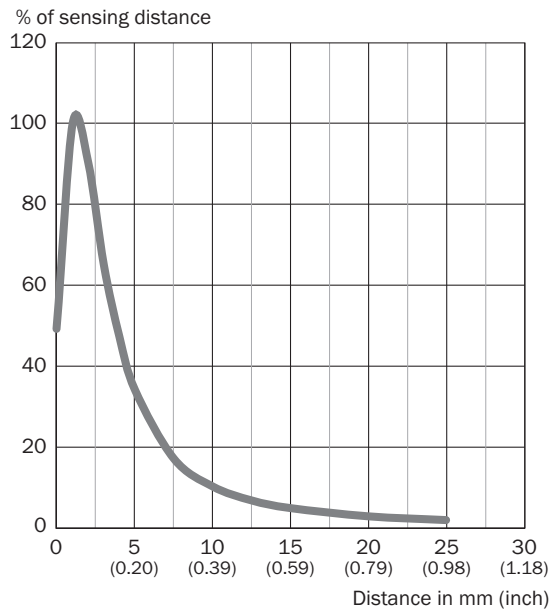

### Sensing distance LL3-DC38

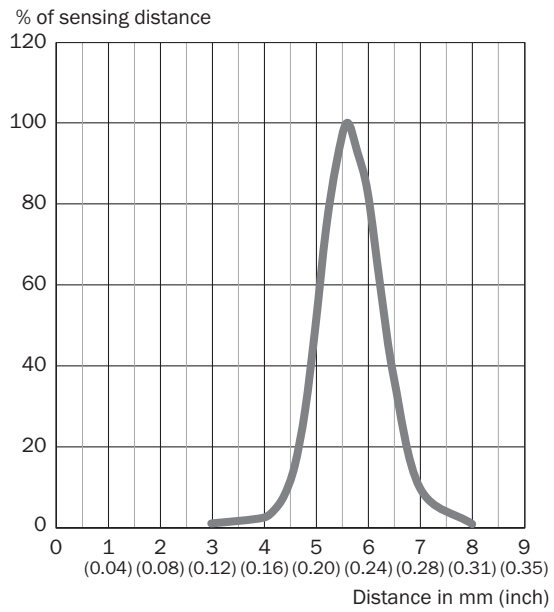

Sensing distance LL3-DM02 (LL3-DA06)

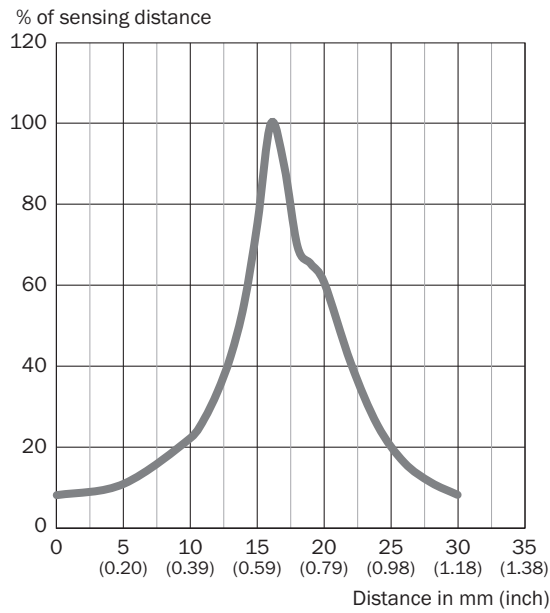

Sensing distance LL3-DM02 (LL3-DA06)

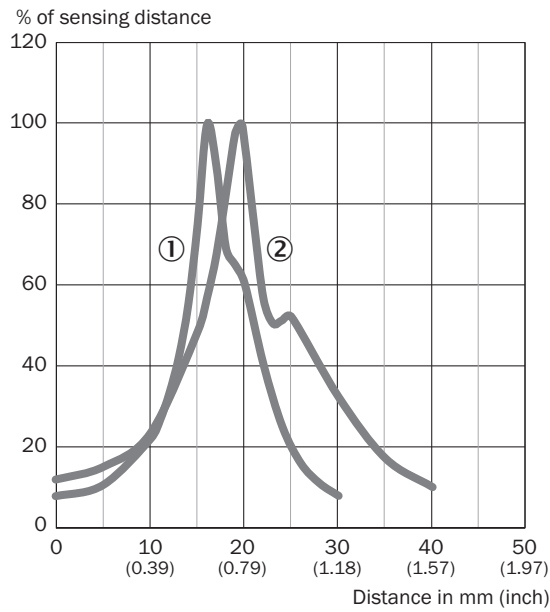

- ① thread with 3 mm distance
- ② Thread screwed flush with the nut

### Sensing distance LL3-DM02 (LL3-DA09)



### Sensing distance LL3-DC09





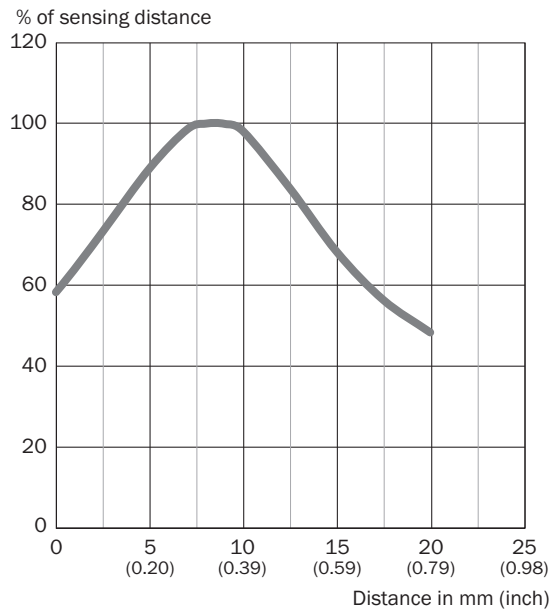





### Sensing distance LL3-DZ01

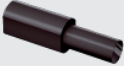
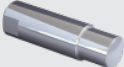

### Recommended accessories

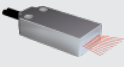
Other models and accessories → [www.sick.com/KTL180](http://www.sick.com/KTL180)

	Brief description	Type	part no.
integration modules and adapters			
	<ul style="list-style-type: none"> <li><b>Description:</b> IO-Link Smart Sensor Gateway for WLL180T, KTL180 and AOD1; Features: IO-Link; COM3; M8 connection, 4-pin; full read/write functionality for the process and service data of the connected sensors. See operating instructions for additional information and technical details</li> </ul>	WI180C-IOA00	6071650
	<ul style="list-style-type: none"> <li><b>Description:</b> EtherCAT coupler for WLL180T, KTL180 and AOD1. Features: EtherCAT; transmission rates of up to 100 Mbaud; M12 EtherCAT connection; M8 voltage supply connection, 4-pin; full read/write functionality for the process and service data of the connected sensors. See operating instructions for additional information and technical details</li> </ul>	WI180C-EC	6068089
	<ul style="list-style-type: none"> <li><b>Description:</b> PROFINET coupler for WLL180T, KTL180 and AOD1. Features: PROFINET IRT; transmission rates 10 Mbaud – 100 Mbaud; M12 PROFINET connection; M8 voltage supply connection, 4-pin; full read/write functionality for the process and service data of the connected sensors. See operating instructions for additional information and technical details</li> </ul>	WI180C-PN	6068088

	Brief description	Type	part no.
fiber-optic sensors			
	<ul style="list-style-type: none"> <li>• <b>Functional principle:</b> Proximity system</li> <li>• <b>Thread diameter (housing):</b> M4</li> </ul>	LL3-DA09	5334040
	<ul style="list-style-type: none"> <li>• <b>Functional principle:</b> Proximity system</li> <li>• <b>Thread diameter (housing):</b> M4</li> </ul>	LL3-DA06	5326468
	<ul style="list-style-type: none"> <li>• <b>For fiber optic amplifiers:</b> GLL70, WLL80, WLL180, GLL170(T), WLL24 Ex</li> <li>• <b>Functional principle:</b> Through-beam system</li> <li>• <b>Fiber length:</b> 2,000 mm</li> <li>• <b>Fiber-optic head array width:</b> 40 mm</li> <li>• <b>Fiber material:</b> Plastic</li> <li>• <b>Jacket material:</b> Plastic</li> <li>• <b>Fiber head material:</b> Plastic</li> <li>• <b>Included with delivery:</b> Mounting, 4 x M3 Phillips-head screw, FC fiber cutter (5304141), protective cladding for fiber head</li> </ul>	LL3-TS40	5323971
	<ul style="list-style-type: none"> <li>• <b>For fiber optic amplifiers:</b> GLL70, WLL80, WLL180, GLL170(T), WLL24 Ex, KTL180</li> <li>• <b>Functional principle:</b> Proximity system</li> <li>• <b>Fiber length:</b> 2,000 mm</li> <li>• <b>Fiber material:</b> Plastic</li> <li>• <b>Jacket material:</b> Plastic</li> <li>• <b>Fiber head material:</b> Plastic</li> <li>• <b>Included with delivery:</b> Adapter sleeves, BF-WLL160-10 (1.0 mm) adapter sleeves, FC fiber cutter (5304141)</li> </ul>	LL3-DC38	5322472
	<ul style="list-style-type: none"> <li>• <b>For fiber optic amplifiers:</b> GLL70, WLL80, WLL180, GLL170(T), WLL24 Ex, KTL180</li> <li>• <b>Functional principle:</b> Proximity system</li> <li>• <b>Fiber length:</b> 2,000 mm</li> <li>• <b>Smooth sleeve diameter:</b> 6 mm</li> <li>• <b>Fiber material:</b> Plastic</li> <li>• <b>Jacket material:</b> Chemical-resistant plastic</li> <li>• <b>Fiber head material:</b> Chemical-resistant plastic</li> <li>• <b>Included with delivery:</b> FC fiber cutter (5304141)</li> </ul>	LL3-DY01	5308093
	<ul style="list-style-type: none"> <li>• <b>For fiber optic amplifiers:</b> GLL70, WLL80, WLL180, GLL170(T), WLL24 Ex</li> <li>• <b>Functional principle:</b> Proximity system</li> <li>• <b>Fiber length:</b> 2,000 mm</li> <li>• <b>Fiber-optic head array width:</b> 4 mm</li> <li>• <b>Fiber material:</b> Plastic</li> <li>• <b>Jacket material:</b> Plastic</li> <li>• <b>Fiber head material:</b> Plastic</li> <li>• <b>Included with delivery:</b> FC fiber cutter (5304141)</li> </ul>	LL3-DZ01	5326013
	<ul style="list-style-type: none"> <li>• <b>For fiber optic amplifiers:</b> GLL70, WLL80, WLL180, GLL170(T), WLL24 Ex</li> <li>• <b>Functional principle:</b> Proximity system</li> <li>• <b>Fiber length:</b> 2,000 mm</li> <li>• <b>Smooth sleeve diameter:</b> 5 mm</li> <li>• <b>Fiber material:</b> Plastic</li> <li>• <b>Jacket material:</b> Plastic</li> <li>• <b>Fiber head material:</b> Stainless steel</li> <li>• <b>Included with delivery:</b> FC fiber cutter (5304141)</li> </ul>	LL3-DV01	5308088
	<ul style="list-style-type: none"> <li>• <b>For fiber optic amplifiers:</b> GLL70, WLL80, WLL180, GLL170(T), WLL24 Ex, KTL180</li> <li>• <b>Functional principle:</b> Proximity system</li> <li>• <b>Fiber length:</b> 2,000 mm</li> <li>• <b>Fiber material:</b> Plastic</li> <li>• <b>Jacket material:</b> Plastic</li> <li>• <b>Fiber head material:</b> Plastic</li> <li>• <b>Included with delivery:</b> Mounting, 2 x M2 hexagon nut, 4 x washer, 2 x M2 Phillips-head screw, adapter sleeves, BF-WLL160-10 (1.0 mm) adapter sleeves, FC fiber cutter (5304141)</li> </ul>	LL3-DC09	5326028
	<ul style="list-style-type: none"> <li>• <b>For fiber optic amplifiers:</b> GLL70, WLL80, WLL180, GLL170(T), WLL24 Ex, KTL180</li> <li>• <b>Functional principle:</b> Proximity system</li> <li>• <b>Fiber length:</b> 2,000 mm</li> <li>• <b>Thread diameter (housing):</b> M6</li> <li>• <b>Fiber material:</b> Plastic</li> <li>• <b>Jacket material:</b> Plastic</li> <li>• <b>Fiber head material:</b> Stainless steel</li> <li>• <b>Included with delivery:</b> Mounting, 2 x M6 hexagon nut, 1 x washer, FC fiber cutter (5304141)</li> </ul>	LL3-DB09	5325991
	<ul style="list-style-type: none"> <li>• <b>For fiber optic amplifiers:</b> GLL70, WLL80, WLL180, GLL170(T), WLL24 Ex, KTL180</li> <li>• <b>Functional principle:</b> Proximity system</li> <li>• <b>Fiber length:</b> 2,000 mm</li> <li>• <b>Smooth sleeve diameter:</b> 3 mm</li> <li>• <b>Fiber material:</b> Plastic</li> </ul>	LL3-DK04	5313020

	Brief description	Type	part no.
	<ul style="list-style-type: none"> <li><b>Jacket material:</b> Plastic</li> <li><b>Fiber head material:</b> Stainless steel</li> <li><b>Included with delivery:</b> Adapter sleeves, BF-WLL160-13 (1.3 mm) adapter sleeves, FC fiber cutter (5304141)</li> </ul>		
	<ul style="list-style-type: none"> <li><b>For fiber optic amplifiers:</b> GLL70, WLL80, WLL180, GLL170(T), WLL24 Ex, KTL180</li> <li><b>Functional principle:</b> Proximity system</li> <li><b>Fiber length:</b> 2,000 mm</li> <li><b>Thread diameter (housing):</b> M4</li> <li><b>Fiber material:</b> Plastic</li> <li><b>Jacket material:</b> Plastic</li> <li><b>Fiber head material:</b> Stainless steel</li> <li><b>Included with delivery:</b> Mounting, 2 x M4 hexagon nut, 2 x washer, adapter sleeves, BF-WLL160-13 (1.3 mm) adapter sleeves, FC fiber cutter (5304141)</li> </ul>	LL3-DM02	5308077
	<ul style="list-style-type: none"> <li><b>For fiber optic amplifiers:</b> GLL70, WLL80, WLL180, GLL170(T), KTL180</li> <li><b>Functional principle:</b> Proximity system</li> <li><b>Fiber length:</b> 2,000 mm</li> <li><b>Thread diameter (housing):</b> M6</li> <li><b>Fiber material:</b> Plastic</li> <li><b>Jacket material:</b> Plastic</li> <li><b>Fiber head material:</b> Stainless steel</li> <li><b>Included with delivery:</b> Mounting, 2 x M6 hexagon nut, 2 x washer, FC fiber cutter (5304141)</li> </ul>	LL3-DB04	5325990
	<ul style="list-style-type: none"> <li><b>For fiber optic amplifiers:</b> GLL70, WLL80, WLL180, GLL170(T), WLL24 Ex, KTL180</li> <li><b>Functional principle:</b> Proximity system</li> <li><b>Fiber length:</b> 2,000 mm</li> <li><b>Thread diameter (housing):</b> M6</li> <li><b>Fiber material:</b> Plastic</li> <li><b>Jacket material:</b> Plastic</li> <li><b>Fiber head material:</b> Stainless steel</li> <li><b>Included with delivery:</b> Mounting, 2 x M6 hexagon nut, 2 x washer, FC fiber cutter (5304141)</li> </ul>	LL3-DB01	5308074
Mounting systems			
	<ul style="list-style-type: none"> <li><b>Description:</b> Rail end piece for block mounting</li> <li><b>Material:</b> Stainless steel</li> <li><b>Details:</b> Stainless steel</li> <li><b>Items supplied:</b> Mounting hardware included</li> </ul>	BEF-EB01-W190	5313011
	<ul style="list-style-type: none"> <li><b>Description:</b> Mounting bracket</li> <li><b>Material:</b> Steel</li> <li><b>Details:</b> Steel, zinc coated</li> <li><b>Items supplied:</b> Without mounting hardware</li> <li><b>Usable for:</b> Fiber-optic sensors</li> <li><b>Suitable for:</b> WLL180T, GLL170(T)</li> </ul>	BEF-WLL180	5325812
	<ul style="list-style-type: none"> <li><b>Description:</b> Fiber cutter, included with delivery of selected fibers</li> <li><b>Dimensions (W x H x L):</b> 10 mm x 37 mm x 65 mm</li> </ul>	FC	5304141
	<ul style="list-style-type: none"> <li><b>Description:</b> Adapter sleeve for LBS/LIS fibers with <math>\varnothing</math> 4.8 mm for adaptation to <math>\varnothing</math> 2.2 mm</li> <li><b>Items supplied:</b> 2 pieces</li> </ul>	Fiber Optic Adaptor Kit	2062854
connectors and cables			
	<ul style="list-style-type: none"> <li><b>Description:</b> Unshielded</li> <li><b>Connection type head A:</b> Male connector, M8, 4-pin, straight, A-coded</li> <li><b>Connection systems:</b> Screw-type terminals</li> <li><b>Permitted cross-section:</b> 0.14 mm<sup>2</sup> ... 0.5 mm<sup>2</sup></li> </ul>	STE-0804-G	6037323
	<ul style="list-style-type: none"> <li><b>Description:</b> Sensor/actuator cable, unshielded</li> <li><b>Connection type head A:</b> Female connector, M8, 4-pin, straight, A-coded</li> <li><b>Connection type head B:</b> Flying leads</li> <li><b>Signal type:</b> Sensor/actuator cable</li> <li><b>Cable:</b> 5 m, 4-wire, PVC</li> <li><b>Application:</b> Uncontaminated zones, Zones with chemicals</li> </ul>	YF8U14-050VA3XLEAX	2095889

## SICK AT A GLANCE

SICK is one of the leading manufacturers of intelligent sensors and sensor solutions for industrial applications. A unique range of products and services creates the perfect basis for controlling processes securely and efficiently, protecting individuals from accidents and preventing damage to the environment.

We have extensive experience in a wide range of industries and understand their processes and requirements. With intelligent sensors, we can deliver exactly what our customers need. In application centers in Europe, Asia and North America, system solutions are tested and optimized in accordance with customer specifications. All this makes us a reliable supplier and development partner.

Comprehensive services complete our offering: SICK LifeTime Services provide support throughout the machine life cycle and ensure safety and productivity.

For us, that is “Sensor Intelligence.”

## WORLDWIDE PRESENCE:

Contacts and other locations –[www.sick.com](http://www.sick.com)