



UM18-21212D212

UM18

ULTRASONIC DISTANCE SENSORS

SICK
Sensor Intelligence.



Ordering information

| Type | part no. |
|----------------|----------|
| UM18-21212D212 | 6066179 |

Other models and accessories → www.sick.com/UM18



Detailed technical data

Features

| | |
|--|--|
| Operating range, limiting range | 65 mm ... 350 mm, 600 mm |
| Resolution | ≥ 0.069 mm |
| Repeatability | ± 0.15 % ¹⁾ |
| Measurement accuracy | ± 1 % ^{2) 3)} |
| Temperature compensation | ✓ |
| Response time | 64 ms ⁴⁾ |
| Switching frequency | 12 Hz |
| Output time | 16 ms |
| Ultrasonic frequency (typical) | 400 kHz |
| Additional function | Adjustable operating modes: Switching point (DtO) / Switching window/Background (ObSB), teach-in of digital output, invertible digital output, teach-in of analog output, Invertible analog output, multifunctional input: external teach / synchronization / multiplexing, synchronization of up to 20 sensors, multiplexing: no cross talk of up to 20 sensors, reset to factory default |
| Safety-related parameters | |
| | MTTF _D 101 years |
| | DC _{avg} 0% |

¹⁾ In relation to the current measured value, minimum value ≥ resolution.

²⁾ Referring to current measurement value.

³⁾ Temperature compensation can be switched off, without temperature compensation: 0.17 % / K.

⁴⁾ Subsequent smoothing of the analog output, depending on the application, may increase the response time by up to 200 %.

Interfaces

| | |
|-----------------------|---|
| IO-Link | ✓ , IO-Link V1.1 |
| Function | Process data, parameterization, diagnosis, data storage |
| Digital output | |
| Number | 1 ¹⁾ |
| Type | Push-pull: PNP/NPN |

¹⁾ Push-pull: PNP/NPN HIGH = U_V - (< 3 V) / LOW < 3 V.

| | |
|-----------------------------------|-------------------------------------|
| Maximum output current I_A | ≤ 100 mA |
| Analog output | |
| Number | 1 |
| Type | Voltage output |
| Voltage | 0 V ... 10 V, $\geq 100,000 \Omega$ |
| Resolution | 12 bit |
| Multifunctional input (MF) | 1 x MF |
| Hysteresis | 5 mm |

¹⁾ Push-pull: PNP/NPN HIGH = $U_V - (< 3 \text{ V})$ / LOW $< 3 \text{ V}$.

Electronics

| | |
|--|------------------------------------|
| Supply voltage U_B | DC 10 V ... 30 V ^{1) 2)} |
| Power consumption | $\leq 1.2 \text{ W}$ ³⁾ |
| Initialization time | < 300 ms |
| Display | 2 x LED |
| Enclosure rating | IP65 / IP67 |
| Protection class | III |

¹⁾ Limit values, reverse-polarity protected Operation in short-circuit protected network: max. 8 A, class 2.

²⁾ 15 V ... 30 V when using the analog voltage output.

³⁾ Without load.

Mechanics

| | |
|-------------------------------|--|
| Dimensions (W x H x D) | 18 mm x 18 mm x 68.7 mm |
| Design | Cylindrical |
| Sending axis | Angled |
| Housing material | Metal (nickel-plated brass, ultrasonic transducer: polyurethane foam, glass epoxy resin) |
| Weight | 30 g |
| Thread size | M18 x 1 |
| Connection type | Male connector, M12, 5-pin |

Ambient data

| | |
|---------------------------------------|---|
| Ambient temperature, operation | $-25 \text{ }^\circ\text{C} \dots +70 \text{ }^\circ\text{C}$ |
| Ambient temperature, storage | $-40 \text{ }^\circ\text{C} \dots +85 \text{ }^\circ\text{C}$ |

Certificates

| | |
|--|---|
| EU declaration of conformity | ✓ |
| UK declaration of conformity | ✓ |
| ACMA declaration of conformity | ✓ |
| Moroccan declaration of conformity | ✓ |
| China RoHS | ✓ |
| cULus certificate | ✓ |
| Information according to Art. 3 of Data Act (Regulation EU 2023/2854) | ✓ |

Classifications

| | |
|-------------------|----------|
| ECLASS 5.0 | 27270804 |
|-------------------|----------|

| | |
|-----------------------|----------|
| ECLASS 5.1.4 | 27270804 |
| ECLASS 6.0 | 27270804 |
| ECLASS 6.2 | 27270804 |
| ECLASS 7.0 | 27270804 |
| ECLASS 8.0 | 27270804 |
| ECLASS 8.1 | 27270804 |
| ECLASS 9.0 | 27270804 |
| ECLASS 10.0 | 27270804 |
| ECLASS 11.0 | 27270804 |
| ECLASS 12.0 | 27272806 |
| ETIM 5.0 | EC001846 |
| ETIM 6.0 | EC001846 |
| ETIM 7.0 | EC001846 |
| ETIM 8.0 | EC001846 |
| UNSPSC 16.0901 | 41111960 |

Dimensional drawing UM18-2xxxxx2

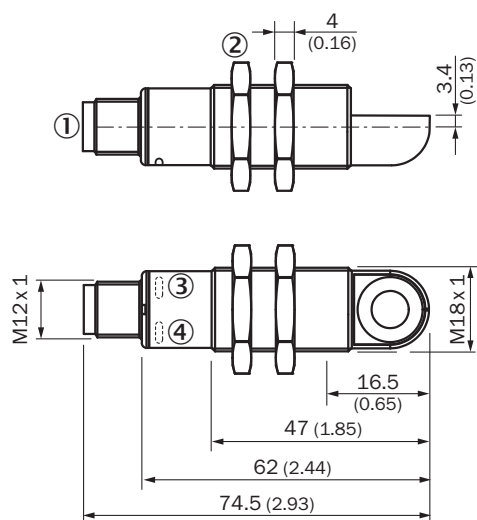

Dimensions in mm (inch)

- ① Connection
- ② Fixing nuts, width 24 mm
- ③ Status display for supply voltage active (green)
- ④ Status indicator switching/analog output (orange)

Connection type



Connection diagram UM18-21xxxCxxx_Dxxx, male connector M12, 5-pin







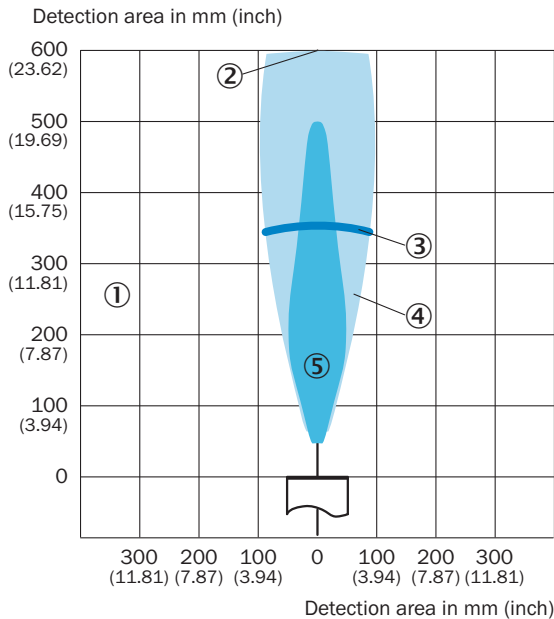

① multifunctional input/synchronization and multiplex operation/communication Connect+

Detection area UM18-212



Recommended accessories

Other models and accessories → www.sick.com/UM18

| | Brief description | Type | part no. |
|---|---|-----------------------------------|----------|
| integration modules and adapters | | | |
|  | | IOLA2US-01101 (SiLink2 Master) | 1061790 |
| Mounting systems | | | |
|  | <ul style="list-style-type: none"> • Description: Mounting plate for M18 sensors • Material: Steel • Details: Steel, zinc coated • Items supplied: Without mounting hardware • Suitable for: GR18, V180-2, V18, W15, Z1, Z2 | BEF-WG-M18 | 5321870 |
| reflectors and optics | | | |
|  | | USP-UM18 | 5323658 |
| connectors and cables | | | |
|  | <ul style="list-style-type: none"> • Description: Sensor/actuator cable, unshielded • Connection type head A: Female connector, M12, 5-pin, straight, A-coded • Connection type head B: Flying leads • Signal type: Sensor/actuator cable • Cable: 2 m, 5-wire, PVC • Application: Uncontaminated zones, Zones with chemicals | YF2A15-020VB5XLEAX | 2096239 |
|  | <ul style="list-style-type: none"> • Description: Sensor/actuator cable, unshielded • Connection type head A: Female connector, M12, 5-pin, straight, A-coded • Connection type head B: Flying leads • Signal type: Sensor/actuator cable • Cable: 0.6 m, 5-wire, PVC • Application: Uncontaminated zones, Zones with chemicals | YF2A15- C60VB5XLEAX | 2145570 |
|  | <ul style="list-style-type: none"> • Description: Sensor/actuator cable, unshielded • Connection type head A: Female connector, M12, 5-pin, straight, A-coded • Connection type head B: Flying leads • Signal type: Sensor/actuator cable • Cable: 3 m, 5-wire, PVC • Application: Uncontaminated zones, Zones with chemicals | YF2A15-030VB5XLEAX | 2145572 |

SICK AT A GLANCE

SICK is one of the leading manufacturers of intelligent sensors and sensor solutions for industrial applications. A unique range of products and services creates the perfect basis for controlling processes securely and efficiently, protecting individuals from accidents and preventing damage to the environment.

We have extensive experience in a wide range of industries and understand their processes and requirements. With intelligent sensors, we can deliver exactly what our customers need. In application centers in Europe, Asia and North America, system solutions are tested and optimized in accordance with customer specifications. All this makes us a reliable supplier and development partner.

Comprehensive services complete our offering: SICK LifeTime Services provide support throughout the machine life cycle and ensure safety and productivity.

For us, that is “Sensor Intelligence.”

WORLDWIDE PRESENCE:

Contacts and other locations –www.sick.com