



# UM18-21712C211

UM18

ULTRASONIC DISTANCE SENSORS

**SICK**  
Sensor Intelligence.



### Ordering information

Type	part no.
UM18-21712C211	6066164

Other models and accessories → [www.sick.com/UM18](http://www.sick.com/UM18)

### Detailed technical data

#### Features

<b>Operating range, limiting range</b>	20 mm ... 150 mm, 250 mm
<b>Resolution</b>	≥ 0.069 mm
<b>Repeatability</b>	± 0.15 % <sup>1)</sup>
<b>Measurement accuracy</b>	± 1 % <sup>2) 3)</sup>
<b>Temperature compensation</b>	✓
<b>Response time</b>	32 ms <sup>4)</sup>
<b>Switching frequency</b>	25 Hz
<b>Output time</b>	8 ms
<b>Ultrasonic frequency (typical)</b>	380 kHz
<b>Additional function</b>	Adjustable operating modes: Switching point (DtO) / Switching window/Background (ObSB), teach-in of digital output, invertible digital output, teach-in of analog output, Invertible analog output, multifunctional input: external teach / synchronization / multiplexing, synchronization of up to 20 sensors, multiplexing: no cross talk of up to 20 sensors, reset to factory default
<b>Safety-related parameters</b>	MTTF <sub>D</sub> 101 years
	DC <sub>avg</sub> 0%

<sup>1)</sup> In relation to the current measured value, minimum value ≥ resolution.

<sup>2)</sup> Referring to current measurement value.

<sup>3)</sup> Temperature compensation can be switched off, without temperature compensation: 0.17 % / K.

<sup>4)</sup> Subsequent smoothing of the analog output, depending on the application, may increase the response time by up to 200 %.

#### Interfaces

<b>IO-Link</b>	✓, IO-Link V1.1
Function	Process data, parameterization, diagnosis, data storage
<b>Digital output</b>	
Number	1 <sup>1)</sup>
Type	Push-pull: PNP/NPN
Maximum output current I <sub>A</sub>	≤ 100 mA
<b>Analog output</b>	

<sup>1)</sup> Push-pull: PNP/NPN HIGH = U<sub>V</sub> - (< 3 V) / LOW < 3 V.

<sup>2)</sup> For 4 mA ... 20 mA and V<sub>S</sub> ≤ 20 V max. load ≤ 100 Ω.

Number	1
Type	Current output
Current	4 mA ... 20 mA, $\leq 500 \Omega$ <sup>2)</sup>
Resolution	12 bit
<b>Multifunctional input (MF)</b>	1 x MF
<b>Hysteresis</b>	2 mm

<sup>1)</sup> Push-pull: PNP/NPN HIGH =  $U_V - (< 3 \text{ V})$  / LOW < 3 V.

<sup>2)</sup> For 4 mA ... 20 mA and  $V_S \leq 20 \text{ V}$  max. load  $\leq 100 \Omega$ .

## Electronics

<b>Supply voltage <math>U_B</math></b>	DC 10 V ... 30 V <sup>1)</sup>
<b>Power consumption</b>	$\leq 1.2 \text{ W}$ <sup>2)</sup>
<b>Initialization time</b>	< 300 ms
<b>Display</b>	2 x LED
<b>Enclosure rating</b>	IP65 / IP67
<b>Protection class</b>	III

<sup>1)</sup> Limit values, reverse-polarity protected Operation in short-circuit protected network: max. 8 A, class 2.

<sup>2)</sup> Without load.

## Mechanics

<b>Dimensions (W x H x D)</b>	18 mm x 18 mm x 52.7 mm
<b>Design</b>	Cylindrical
<b>Sending axis</b>	Straight
<b>Housing material</b>	Metal (nickel-plated brass, ultrasonic transducer: polyurethane foam, glass epoxy resin)
<b>Weight</b>	25 g
<b>Thread size</b>	M18 x 1
<b>Connection type</b>	Male connector, M12, 5-pin

## Ambient data

<b>Ambient temperature, operation</b>	-25 °C ... +70 °C
<b>Ambient temperature, storage</b>	-40 °C ... +85 °C

## Classifications

<b>ECLASS 5.0</b>	27270804
<b>ECLASS 5.1.4</b>	27270804
<b>ECLASS 6.0</b>	27270804
<b>ECLASS 6.2</b>	27270804
<b>ECLASS 7.0</b>	27270804
<b>ECLASS 8.0</b>	27270804
<b>ECLASS 8.1</b>	27270804
<b>ECLASS 9.0</b>	27270804
<b>ECLASS 10.0</b>	27270804
<b>ECLASS 11.0</b>	27270804
<b>ECLASS 12.0</b>	27272806

<b>ETIM 5.0</b>	EC001846
<b>ETIM 6.0</b>	EC001846
<b>ETIM 7.0</b>	EC001846
<b>ETIM 8.0</b>	EC001846
<b>UNSPSC 16.0901</b>	41111960

Dimensional drawing UM18-2xxxxx1

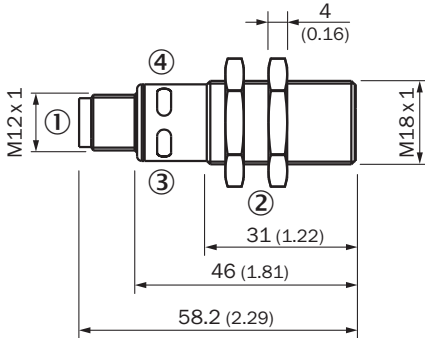

Dimensions in mm (inch)

- ① Connection
- ② Fixing nuts, width 24 mm
- ③ Status display for supply voltage active (green)
- ④ Status indicator switching/analog output (orange)

Connection type

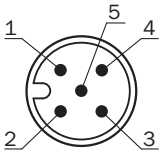

Connection diagram UM18-21xxxCxxx\_Dxxx, male connector M12, 5-pin

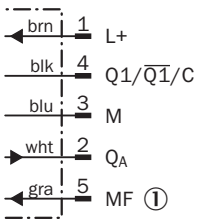

① multifunctional input/synchronization and multiplex operation/communication Connect+



## Detection area UM1x-x17





- ① Detection range dependent on reflection properties, size, and alignment of the object
- ② Limiting range
- ③ operating range
- ④ example object: aligned plate 500 mm x 500 mm
- ⑤ Example object: cylindrical bar with a diameter of 10 mm

## Recommended accessories

Other models and accessories → [www.sick.com/UM18](http://www.sick.com/UM18)

	Brief description	Type	part no.
integration modules and adapters			
		IOLA2US-01101 (SiLink2 Master)	1061790
Mounting systems			
	<ul style="list-style-type: none"> <li>• <b>Description:</b> Mounting plate for M18 sensors</li> <li>• <b>Material:</b> Steel</li> <li>• <b>Details:</b> Steel, zinc coated</li> <li>• <b>Items supplied:</b> Without mounting hardware</li> <li>• <b>Suitable for:</b> GR18, V180-2, V18, W15, Z1, Z2</li> </ul>	BEF-WG-M18	5321870
reflectors and optics			
		USP-UM18	5323658

	Brief description	Type	part no.
connectors and cables			
	<ul style="list-style-type: none"> <li>• <b>Description:</b> Sensor/actuator cable, unshielded</li> <li>• <b>Connection type head A:</b> Female connector, M12, 5-pin, straight, A-coded</li> <li>• <b>Connection type head B:</b> Flying leads</li> <li>• <b>Signal type:</b> Sensor/actuator cable</li> <li>• <b>Cable:</b> 2 m, 5-wire, PVC</li> <li>• <b>Application:</b> Uncontaminated zones, Zones with chemicals</li> </ul>	YF2A15-020VB5XLEAX	2096239
	<ul style="list-style-type: none"> <li>• <b>Description:</b> Sensor/actuator cable, unshielded</li> <li>• <b>Connection type head A:</b> Female connector, M12, 5-pin, straight, A-coded</li> <li>• <b>Connection type head B:</b> Flying leads</li> <li>• <b>Signal type:</b> Sensor/actuator cable</li> <li>• <b>Cable:</b> 0.6 m, 5-wire, PVC</li> <li>• <b>Application:</b> Uncontaminated zones, Zones with chemicals</li> </ul>	YF2A15-C60VB5XLEAX	2145570
	<ul style="list-style-type: none"> <li>• <b>Description:</b> Sensor/actuator cable, unshielded</li> <li>• <b>Connection type head A:</b> Female connector, M12, 5-pin, straight, A-coded</li> <li>• <b>Connection type head B:</b> Flying leads</li> <li>• <b>Signal type:</b> Sensor/actuator cable</li> <li>• <b>Cable:</b> 3 m, 5-wire, PVC</li> <li>• <b>Application:</b> Uncontaminated zones, Zones with chemicals</li> </ul>	YF2A15-030VB5XLEAX	2145572

## SICK AT A GLANCE

SICK is one of the leading manufacturers of intelligent sensors and sensor solutions for industrial applications. A unique range of products and services creates the perfect basis for controlling processes securely and efficiently, protecting individuals from accidents and preventing damage to the environment.

We have extensive experience in a wide range of industries and understand their processes and requirements. With intelligent sensors, we can deliver exactly what our customers need. In application centers in Europe, Asia and North America, system solutions are tested and optimized in accordance with customer specifications. All this makes us a reliable supplier and development partner.

Comprehensive services complete our offering: SICK LifeTime Services provide support throughout the machine life cycle and ensure safety and productivity.

For us, that is “Sensor Intelligence.”

## WORLDWIDE PRESENCE:

Contacts and other locations –[www.sick.com](http://www.sick.com)