



LBV320-XTGDTKMX02000

LBV3xx

LEVEL SENSORS

SICK
Sensor Intelligence.



Ordering information

Type	part no.
LBV320-XXTGDTKMX02000	6065850

Other models and accessories → www.sick.com/LBV3xx

Illustration may differ



Detailed technical data

Features

Medium	Bulk solids
Measurement	Switch
Probe type	Tuning fork
Probe length	2,000 mm
Process pressure	-1 bar ... 6 bar
Process temperature	-20 °C ... +80 °C
Fill material density	≥ 0.008 g/cm ³
Particle size	< 10 mm
Tensile strength	≤ 3,000 N

Performance

Accuracy of sensor element	± 10 mm
Reproducibility	≤ 5 mm
Response time	500 ms ¹⁾ 1,000 ms ²⁾
MTBF	4,61*10 ⁶ h

¹⁾ When covered.

²⁾ When uncovered.

Electronics

Communication interface	-
Supply voltage	10 V DC ... 55 V DC
Residual ripple	≤ 5 V _{pp}
Initialization time	< 2 s
VDE protection class 2	✓
Connection type	M20 x 1.5
Output signal	1 x PNP/NPN
Electronics	Volt-free transistor output PNP/ NPN
Hysteresis	10 mm

Output current	< 300 mA
Inductive load	≤ 1 H
Capacitive load	100 nF
Enclosure rating	IP66 IP67

Mechanics

Wetted parts	Stainless steel 1.4404 / 316L
Process connection	G 1½ A PN 6
Housing material	Plastic
Sensor material	Stainless steel 316L, 318LN, PUR

Ambient data

Ambient operating temperature	-40 °C ... +80 °C
Ambient temperature, storage	-40 °C ... +80 °C

Certificates

EU declaration of conformity	✓
UK declaration of conformity	✓
ACMA declaration of conformity	✓
China RoHS	✓

Classifications

ECLASS 5.0	27273202
ECLASS 5.1.4	27273202
ECLASS 6.0	27273202
ECLASS 6.2	27273202
ECLASS 7.0	27273202
ECLASS 8.0	27273202
ECLASS 8.1	27273202
ECLASS 9.0	27273202
ECLASS 10.0	27273202
ECLASS 11.0	27273202
ECLASS 12.0	27273106
ETIM 5.0	EC002654
ETIM 6.0	EC002654
ETIM 7.0	EC002654
ETIM 8.0	EC002654
UNSPSC 16.0901	41111938

Dimensional drawing LBV320 with PUR suspension cable, threaded version G 1½ A (DIN ISO 228/1)

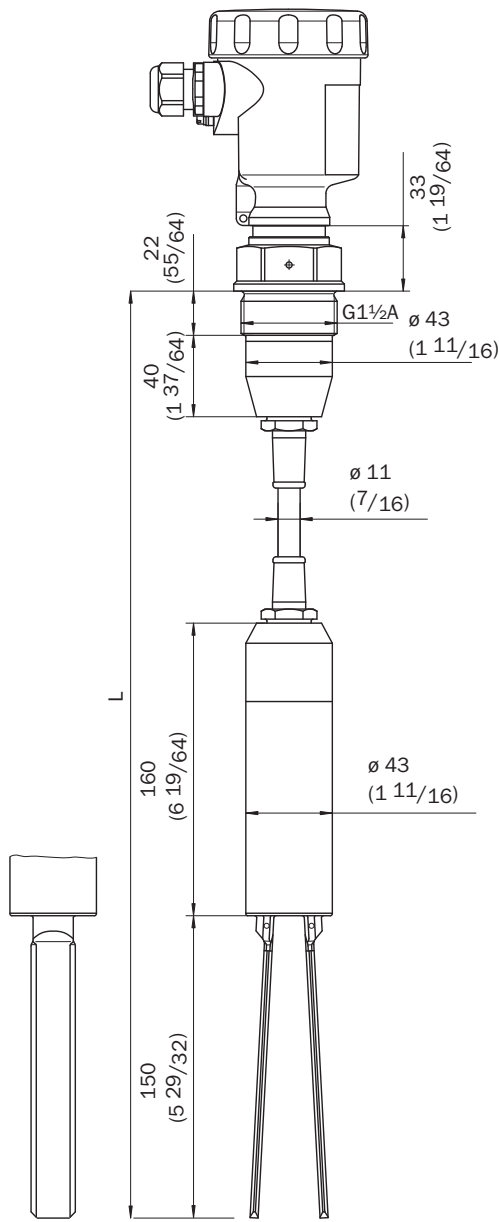

Dimensions in mm (inch)

Dimensional drawing Temperature adapter



Dimensions in mm (inch)

Connection diagram NPN action



Connection diagram Transistor connection diagram



Connection diagram PNP action

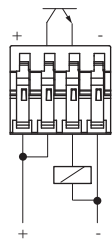

Instruction for installation Filling in the center, emptying laterally

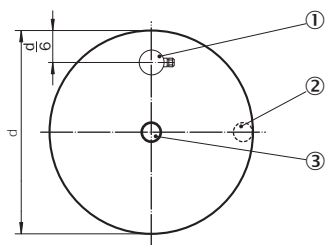
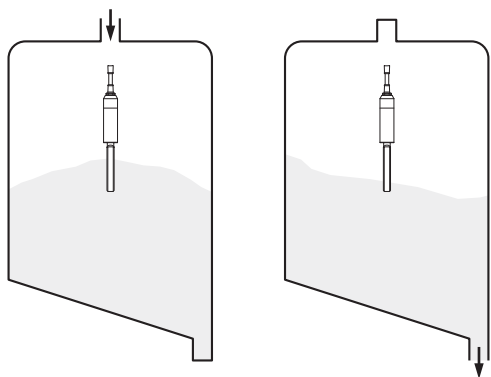

- ① LBV320
- ② Discharge opening
- ③ Filling opening

Instruction for installation LBV320 Filling and emptying centered

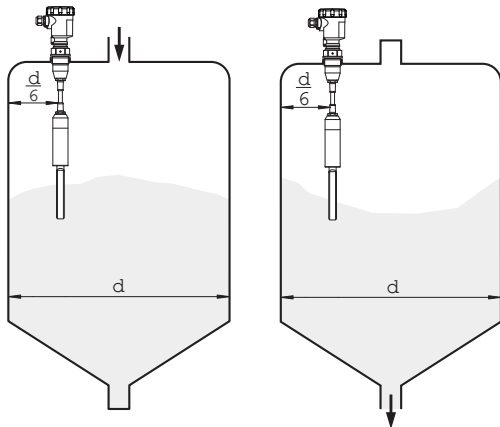

Instruction for installation Flow orientation of the tuning fork

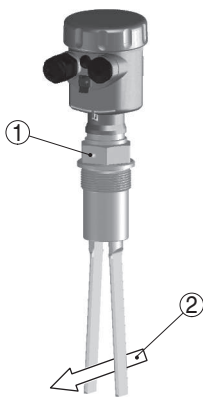

- ① Marking with screwed version
- ② Direction of flow

Instruction for installation Horizontal mounting

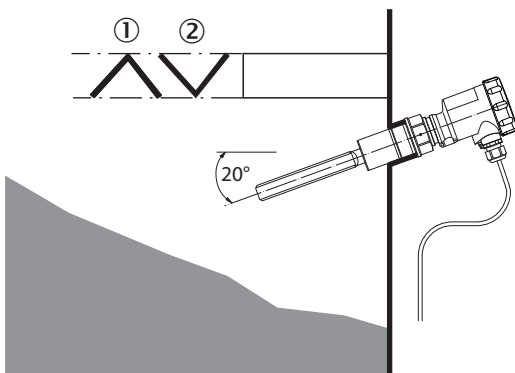

- ① Protective sheet

② Concave protective sheet for abrasive solids

Recommended accessories

Other models and accessories → www.sick.com/LBV3xx

	Brief description	Type	part no.
Mounting systems			
	<ul style="list-style-type: none"> Description: Locking screw connection, process pressure -1 bar to 16 bar, process connection G 2 A, inner thread G 1 1/2 A Material: Stainless steel Details: Stainless steel 316L 	BEF-MU-316G20-ALBV	5322462
Power supply units and power supply cables			
	<ul style="list-style-type: none"> Description: Transistor (PNP/NPN): 10 V DC ... 55 V DC 	ECD-RE-LB-VPNP-0001	6038667

SICK AT A GLANCE

SICK is one of the leading manufacturers of intelligent sensors and sensor solutions for industrial applications. A unique range of products and services creates the perfect basis for controlling processes securely and efficiently, protecting individuals from accidents and preventing damage to the environment.

We have extensive experience in a wide range of industries and understand their processes and requirements. With intelligent sensors, we can deliver exactly what our customers need. In application centers in Europe, Asia and North America, system solutions are tested and optimized in accordance with customer specifications. All this makes us a reliable supplier and development partner.

Comprehensive services complete our offering: SICK LifeTime Services provide support throughout the machine life cycle and ensure safety and productivity.

For us, that is “Sensor Intelligence.”

WORLDWIDE PRESENCE:

Contacts and other locations –www.sick.com