



LFBV330-XXGAVXPC0250

LFBV300

LEVEL SENSORS

SICK
Sensor Intelligence.



Illustration may differ



Ordering information

Type	part no.
LFV330-XXGAVXPC0250	6064423

Other models and accessories → www.sick.com/LFV300

Detailed technical data

Features

Measurement	Switch
Probe length	250 mm
Process pressure	-1 bar ... 64 bar
Process temperature	-50 °C ... +150 °C
Fill material density	0.5 g/cm ³ ... 2.5 g/cm ³

Performance

Accuracy of sensor element	± 2 mm
Reproducibility	≤ 1 mm
Viscosity	0.1 mPas ... 10,000 mPas
Response time	500 ms
MTBF	9,73*10 ⁶ h

Electronics

Communication interface	-
Supply voltage	20 V AC/DC ... 253 V AC/DC
Power consumption	< 4.2 mA
Initialization time	< 3 s
VDE protection class 1	✓
VDE protection class 2	✓
Connection type	M20 x 1.5
Output signal	Non-contact switch
Electronics	Non-contact switch
Hysteresis	2 mm
Output current	< 400 mA
Inductive load	≤ 1 H
Capacitive load	100 nF
Enclosure rating	IP66 / IP67

Temperature drift	0.03 mm/K
--------------------------	-----------

Mechanics

Wetted parts	Stainless steel 316L (optional Ra ≤ 0.8 μm)
Process connection	G 1 A PN 64
Housing material	Plastic
Sensor material	Stainless steel 1.4404

Ambient data

Ambient operating temperature	-40 °C ... +70 °C
Ambient temperature, storage	-40 °C ... +80 °C

Certificates

EU declaration of conformity	✓
UK declaration of conformity	✓
ACMA declaration of conformity	✓
China RoHS	✓
FDA certificate	✓

Classifications

ECLASS 5.0	27273202
ECLASS 5.1.4	27273202
ECLASS 6.0	27273202
ECLASS 6.2	27273202
ECLASS 7.0	27273202
ECLASS 8.0	27273202
ECLASS 8.1	27273202
ECLASS 9.0	27273202
ECLASS 10.0	27273202
ECLASS 11.0	27273202
ECLASS 12.0	27273106
ETIM 5.0	EC002654
ETIM 6.0	EC002654
ETIM 7.0	EC002654
ETIM 8.0	EC002654
UNSPSC 16.0901	41111938

Dimensional drawing Marking on the welded flange



Dimensions in mm (inch)
 ① Marking

Dimensional drawing LFV330



Dimensions in mm (inch)
 ① Thread
 ② Tri-Clamp
 ③ DN 25 cone
 ④ Bolting D 40
 ⑤ Flange
 ⑥ Gas-tight leadthrough
 ⑦ Temperature adapter

Connection diagram Contactless electronic switch connection diagram

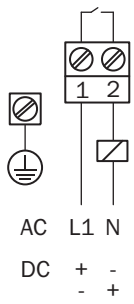

Connection type LFV300 Contactless electronic switch - electronic module

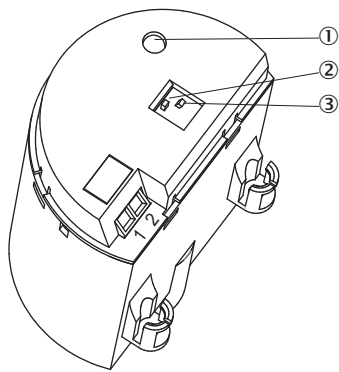

Instruction for installation Inflowing medium

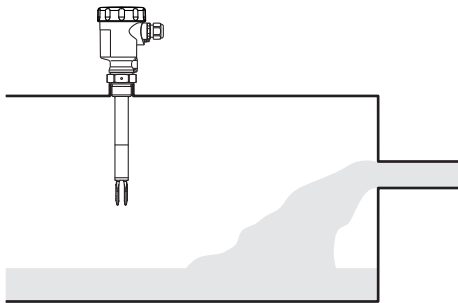







Characteristic curve Influence of the process temperature on the switching point

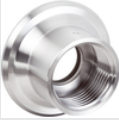

- ① Shifting of the switching point in mm (in)
- ② Process temperature in °C (°F)
- ③ Switching point at reference conditions (notch)
- ④ Tuning fork

Recommended accessories

Other models and accessories → www.sick.com/LFV300

	Brief description	Type	part no.
Mounting systems			
	<ul style="list-style-type: none"> Description: Lock nut fitting, process pressure –1 bar to 64 bar, G 1 A process connection, G 3/4 A female thread Material: Stainless steel Details: Stainless steel 316L 	BEF-MU-316G10-ALFV	5322463
	<ul style="list-style-type: none"> Description: Welded flange/welded connector, process connection G 1 Material: Stainless steel Details: Stainless steel 1.4404 	BEF-FL-GEWG10-LFV2	4054605
	<ul style="list-style-type: none"> Description: Welded flange/welded connector, G 3/4 process connection Material: Stainless steel Details: Stainless steel 1.4404 	BEF-FL-GEWG34-LFV2	4054604
	<ul style="list-style-type: none"> Description: Welded flange/welded connector, process connection Tri-Clamp 1" Material: Stainless steel Details: Stainless steel 1.4404 	BEF-FL-TCL110-LFV2	5321678
	<ul style="list-style-type: none"> Description: Welded flange/welded connector, process connection Tri-Clamp 2" Material: Stainless steel Details: Stainless steel 1.4404 	BEF-FL-TCL120-LFV2	5321679
	<ul style="list-style-type: none"> Description: Welded flange/welded connector, DIN11851-1, DN25 / PN40 Material: Stainless steel Details: Stainless steel 1.4404 	BEF-FL-851D25-LFV2	5321527
Power supply units and power supply cables			
	<ul style="list-style-type: none"> Description: Contactless switch: 20 V AC/DC ... 250 V AC/DC 	ECD-RE-LFVKOS-0001	6038669

SICK AT A GLANCE

SICK is one of the leading manufacturers of intelligent sensors and sensor solutions for industrial applications. A unique range of products and services creates the perfect basis for controlling processes securely and efficiently, protecting individuals from accidents and preventing damage to the environment.

We have extensive experience in a wide range of industries and understand their processes and requirements. With intelligent sensors, we can deliver exactly what our customers need. In application centers in Europe, Asia and North America, system solutions are tested and optimized in accordance with customer specifications. All this makes us a reliable supplier and development partner.

Comprehensive services complete our offering: SICK LifeTime Services provide support throughout the machine life cycle and ensure safety and productivity.

For us, that is “Sensor Intelligence.”

WORLDWIDE PRESENCE:

Contacts and other locations –www.sick.com