



# THTS-1PBC31506MZ

THTS

TEMPERATURE SENSORS

**SICK**  
Sensor Intelligence.



Illustration may differ

## Ordering information

Type	part no.
THTS-1PBC31506MZ	6063734

Other models and accessories → [www.sick.com/THTS](http://www.sick.com/THTS)

## Detailed technical data

### Features

<b>Measuring range</b>	-50 °C ... +250 °C
<b>Sensor element</b>	Pt100
<b>Output signal</b>	Pt100, 4-wire

### Mechanics/electronics

<b>Communication interface</b>	-
<b>Process connection</b>	Clamp (ISO 2852) DN 25, DN 33.7, DN 38
<b>Seal</b>	Without seal
<b>Insertion length/diameter of probe</b>	150 mm / 6 mm
<b>Wetted parts</b>	Stainless steel 1.4435 / 316L, $R_a \leq 0.8 \mu\text{m}$
<b>Maximum process pressure</b>	$\leq 16 \text{ bar}^1$
<b>Pressure resistance</b>	Max. 16 bar at room temperature
<b>Housing material</b>	Stainless steel (CrNi)
<b>Connection type</b>	M12 round connector x 1, 4-pin <sup>2)</sup>
<b>Enclosure rating</b>	IP67 <sup>3)</sup> IP69 <sup>3)</sup>
<b>Measuring current</b>	0.1 mA ... 1 mA
<b>Electrical safety</b>	Protection class: III, dielectric strength: 500 V AC
<b>Protection class III</b>	✓
<b>Initialization time</b>	Max. 4 s

<sup>1)</sup> Pressure resistance at room temperature.

<sup>2)</sup> The enclosure rating classes specified only apply while the thermometer is connected with female connectors that provide the corresponding enclosure rating.

<sup>3)</sup> IP enclosure rating as per IEC 60529.

### Performance

<b>Accuracy of sensor element</b>	Class A according to IEC 60751 <sup>1)</sup>
<b>Response time</b>	$t_{50} \leq 3.3 \text{ s}^2$ $t_{90} \leq 9.7 \text{ s}^2$

<sup>1)</sup> Class B (measuring range -50 °C ... -30 °C).

<sup>2)</sup> Depending on sensor configuration, according to IEC 60751.

## Ambient data

<b>Ambient temperature</b>	-40 °C ... +85 °C
<b>Storage and transport temperature</b>	-40 °C ... +85 °C
<b>Shock resistance</b>	50 g, 6ms (according to IEC 60068-2-27)
<b>Relative humidity</b>	≤ 100 % <sup>1)</sup>

<sup>1)</sup> Condensation allowed.

## Certificates

<b>China RoHS</b>	✓
-------------------	---

## Classifications

<b>ECLASS 5.0</b>	27200208
<b>ECLASS 5.1.4</b>	27200208
<b>ECLASS 6.0</b>	27200208
<b>ECLASS 6.2</b>	27200208
<b>ECLASS 7.0</b>	27200208
<b>ECLASS 8.0</b>	27200208
<b>ECLASS 8.1</b>	27200208
<b>ECLASS 9.0</b>	27200208
<b>ECLASS 10.0</b>	27200208
<b>ECLASS 11.0</b>	27200208
<b>ECLASS 12.0</b>	27200208
<b>ETIM 5.0</b>	EC002994
<b>ETIM 6.0</b>	EC002994
<b>ETIM 7.0</b>	EC002994
<b>ETIM 8.0</b>	EC002994
<b>UNSPSC 16.0901</b>	41112211

Dimensional drawing

Pt100, 4 mA...20 mA,  
up to 150°C

Pt100, 4 mA...20 mA,  
up to 250°C

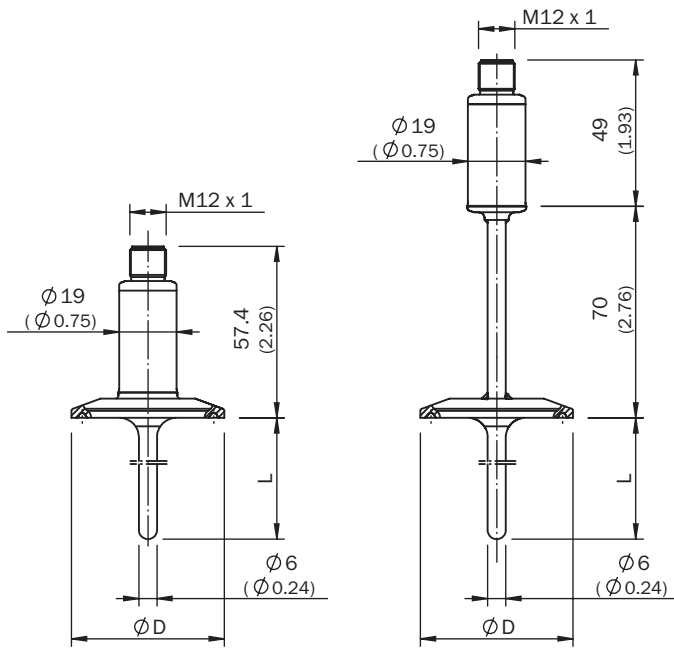

All dimensions in mm (inch)

Design		Ø D
<b>DIN 32676</b>	DN 10 ... DN 20	34.0 (1.34)
	DN 25 ... DN 40	50.5 (1.99)
	DN 50	64.0 (2.52)
<b>ISO 2852</b>	DN 12 ... DN 21.3	34.0 (1.34)
	DN 25 ... DN 38	50.5 (1.99)
	DN 40, DN 51	64.0 (2.52)
<b>Tri-Clamp</b>	1", 1 ½"	50.5 (1.99)
	2"	64.0 (2.52)

Dimensions in mm (inch)

## Application





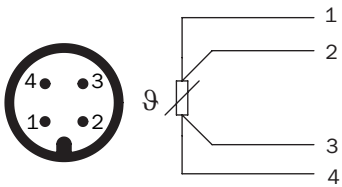







Connection type Round connector M12 x 1, output signal Pt100



### Recommended accessories

Other models and accessories → [www.sick.com/THTS](http://www.sick.com/THTS)

	Brief description	Type	part no.
connectors and cables			
	<ul style="list-style-type: none"> <li>• <b>Connection type head A:</b> Female connector, M12, 4-pin, straight, A-coded</li> <li>• <b>Connection type head B:</b> Flying leads</li> <li>• <b>Signal type:</b> Sensor/actuator cable</li> <li>• <b>Cable:</b> 2 m, 4-wire, PUR, halogen-free</li> <li>• <b>Description:</b> Sensor/actuator cable, unshielded</li> <li>• <b>Application:</b> Untaminated zones, Zones with oils and lubricants, Robot, Drag chain operation</li> </ul>	YF2A14-020UB3XLEAX	2095607
	<ul style="list-style-type: none"> <li>• <b>Connection type head A:</b> Female connector, M12, 4-pin, straight, A-coded</li> <li>• <b>Connection type head B:</b> Flying leads</li> <li>• <b>Signal type:</b> Sensor/actuator cable</li> <li>• <b>Cable:</b> 5 m, 4-wire, PUR, halogen-free</li> <li>• <b>Description:</b> Sensor/actuator cable, unshielded</li> <li>• <b>Application:</b> Untaminated zones, Zones with oils and lubricants, Robot, Drag chain operation</li> </ul>	YF2A14-050UB3XLEAX	2095608
	<ul style="list-style-type: none"> <li>• <b>Connection type head A:</b> Female connector, M12, 4-pin, straight, A-coded</li> <li>• <b>Connection type head B:</b> Flying leads</li> <li>• <b>Signal type:</b> Sensor/actuator cable</li> <li>• <b>Cable:</b> 10 m, 4-wire, PUR, halogen-free</li> <li>• <b>Description:</b> Sensor/actuator cable, unshielded</li> <li>• <b>Application:</b> Untaminated zones, Zones with oils and lubricants, Robot, Drag chain operation</li> </ul>	YF2A14-100UB3XLEAX	2095609
	<ul style="list-style-type: none"> <li>• <b>Connection type head A:</b> Female connector, M12, 4-pin, angled, A-coded</li> <li>• <b>Connection type head B:</b> Flying leads</li> <li>• <b>Signal type:</b> Sensor/actuator cable</li> <li>• <b>Cable:</b> 2 m, 4-wire, PUR, halogen-free</li> <li>• <b>Description:</b> Sensor/actuator cable, unshielded</li> <li>• <b>Application:</b> Untaminated zones, Zones with oils and lubricants, Robot, Drag chain operation</li> </ul>	YG2A14-020UB3XLEAX	2095766
	<ul style="list-style-type: none"> <li>• <b>Connection type head A:</b> Female connector, M12, 4-pin, angled, A-coded</li> <li>• <b>Connection type head B:</b> Flying leads</li> <li>• <b>Signal type:</b> Sensor/actuator cable</li> <li>• <b>Cable:</b> 5 m, 4-wire, PUR, halogen-free</li> <li>• <b>Description:</b> Sensor/actuator cable, unshielded</li> <li>• <b>Application:</b> Untaminated zones, Zones with oils and lubricants, Robot, Drag chain operation</li> </ul>	YG2A14-050UB3XLEAX	2095767
	<ul style="list-style-type: none"> <li>• <b>Connection type head A:</b> Female connector, M12, 4-pin, angled, A-coded</li> <li>• <b>Connection type head B:</b> Flying leads</li> <li>• <b>Signal type:</b> Sensor/actuator cable</li> <li>• <b>Cable:</b> 10 m, 4-wire, PUR, halogen-free</li> <li>• <b>Description:</b> Sensor/actuator cable, unshielded</li> <li>• <b>Application:</b> Untaminated zones, Zones with oils and lubricants, Robot, Drag chain operation</li> </ul>	YG2A14-100UB3XLEAX	2095768
	<ul style="list-style-type: none"> <li>• <b>Connection type head A:</b> Female connector, M12, 4-pin, straight, A-coded</li> <li>• <b>Connection type head B:</b> Flying leads</li> <li>• <b>Signal type:</b> Sensor/actuator cable</li> <li>• <b>Cable:</b> 2 m, 4-wire, PVC</li> <li>• <b>Description:</b> Sensor/actuator cable, unshielded</li> <li>• <b>Application:</b> Zones with chemicals, Untaminated zones</li> </ul>	YF2A14-020VB3XLEAX	2096234
	<ul style="list-style-type: none"> <li>• <b>Connection type head A:</b> Female connector, M12, 4-pin, straight, A-coded</li> <li>• <b>Connection type head B:</b> Flying leads</li> <li>• <b>Signal type:</b> Sensor/actuator cable</li> <li>• <b>Cable:</b> 5 m, 4-wire, PVC</li> <li>• <b>Description:</b> Sensor/actuator cable, unshielded</li> <li>• <b>Application:</b> Zones with chemicals, Untaminated zones</li> </ul>	YF2A14-050VB3XLEAX	2096235
	<ul style="list-style-type: none"> <li>• <b>Connection type head A:</b> Female connector, M12, 4-pin, straight, A-coded</li> <li>• <b>Connection type head B:</b> Flying leads</li> <li>• <b>Signal type:</b> Sensor/actuator cable</li> <li>• <b>Cable:</b> 10 m, 4-wire, PVC</li> <li>• <b>Description:</b> Sensor/actuator cable, unshielded</li> <li>• <b>Application:</b> Zones with chemicals, Untaminated zones</li> </ul>	YF2A14-100VB3XLEAX	2096236
	<ul style="list-style-type: none"> <li>• <b>Connection type head A:</b> Female connector, M12, 4-pin, straight, A-coded</li> <li>• <b>Connection type head B:</b> Flying leads</li> <li>• <b>Signal type:</b> Sensor/actuator cable</li> <li>• <b>Cable:</b> 15 m, 4-wire, PVC</li> <li>• <b>Description:</b> Sensor/actuator cable, unshielded</li> </ul>	YF2A14-150VB3XLEAX	2096237

	Brief description	Type	part no.
	<ul style="list-style-type: none"> <li>• <b>Application:</b> Zones with chemicals, Uncontaminated zones</li> <li>• <b>Connection type head A:</b> Female connector, M12, 4-pin, angled, A-coded</li> <li>• <b>Connection type head B:</b> Flying leads</li> <li>• <b>Signal type:</b> Sensor/actuator cable</li> <li>• <b>Cable:</b> 2 m, 4-wire, PVC</li> <li>• <b>Description:</b> Sensor/actuator cable, unshielded</li> <li>• <b>Application:</b> Zones with chemicals, Uncontaminated zones</li> </ul>	YG2A14-020VB3XLEAX	2095895
	<ul style="list-style-type: none"> <li>• <b>Connection type head A:</b> Female connector, M12, 4-pin, angled, A-coded</li> <li>• <b>Connection type head B:</b> Flying leads</li> <li>• <b>Signal type:</b> Sensor/actuator cable</li> <li>• <b>Cable:</b> 5 m, 4-wire, PVC</li> <li>• <b>Description:</b> Sensor/actuator cable, unshielded</li> <li>• <b>Application:</b> Zones with chemicals, Uncontaminated zones</li> </ul>	YG2A14-050VB3XLEAX	2095897
	<ul style="list-style-type: none"> <li>• <b>Connection type head A:</b> Female connector, M12, 4-pin, angled, A-coded</li> <li>• <b>Connection type head B:</b> Flying leads</li> <li>• <b>Signal type:</b> Sensor/actuator cable</li> <li>• <b>Cable:</b> 10 m, 4-wire, PVC</li> <li>• <b>Description:</b> Sensor/actuator cable, unshielded</li> <li>• <b>Application:</b> Zones with chemicals, Uncontaminated zones</li> </ul>	YG2A14-100VB3XLEAX	2095898
	<ul style="list-style-type: none"> <li>• <b>Connection type head A:</b> Female connector, M12, 4-pin, straight, A-coded</li> <li>• <b>Connection type head B:</b> Flying leads</li> <li>• <b>Signal type:</b> Sensor/actuator cable</li> <li>• <b>Cable:</b> 0.6 m, 4-wire, PUR, halogen-free</li> <li>• <b>Description:</b> Sensor/actuator cable, unshielded</li> <li>• <b>Application:</b> Uncontaminated zones, Zones with oils and lubricants, Robot, Drag chain operation</li> </ul>	YF2A14-C60UB3XLEAX	2145654
	<ul style="list-style-type: none"> <li>• <b>Connection type head A:</b> Female connector, M12, 4-pin, straight, A-coded</li> <li>• <b>Connection type head B:</b> Flying leads</li> <li>• <b>Signal type:</b> Sensor/actuator cable</li> <li>• <b>Cable:</b> 1 m, 4-wire, PUR, halogen-free</li> <li>• <b>Description:</b> Sensor/actuator cable, unshielded</li> <li>• <b>Application:</b> Uncontaminated zones, Zones with oils and lubricants, Robot, Drag chain operation</li> </ul>	YF2A14-010UB3XLEAX	2145655
	<ul style="list-style-type: none"> <li>• <b>Connection type head A:</b> Female connector, M12, 4-pin, straight, A-coded</li> <li>• <b>Connection type head B:</b> Flying leads</li> <li>• <b>Signal type:</b> Sensor/actuator cable</li> <li>• <b>Cable:</b> 3 m, 4-wire, PUR, halogen-free</li> <li>• <b>Description:</b> Sensor/actuator cable, unshielded</li> <li>• <b>Application:</b> Uncontaminated zones, Zones with oils and lubricants, Robot, Drag chain operation</li> </ul>	YF2A14-030UB3XLEAX	2145656
	<ul style="list-style-type: none"> <li>• <b>Connection type head A:</b> Female connector, M12, 4-pin, angled, A-coded</li> <li>• <b>Connection type head B:</b> Flying leads</li> <li>• <b>Signal type:</b> Sensor/actuator cable</li> <li>• <b>Cable:</b> 0.6 m, 4-wire, PUR, halogen-free</li> <li>• <b>Description:</b> Sensor/actuator cable, unshielded</li> <li>• <b>Application:</b> Uncontaminated zones, Zones with oils and lubricants, Robot, Drag chain operation</li> </ul>	YG2A14-C60UB3XLEAX	2145657
	<ul style="list-style-type: none"> <li>• <b>Connection type head A:</b> Female connector, M12, 4-pin, angled, A-coded</li> <li>• <b>Connection type head B:</b> Flying leads</li> <li>• <b>Signal type:</b> Sensor/actuator cable</li> <li>• <b>Cable:</b> 1 m, 4-wire, PUR, halogen-free</li> <li>• <b>Description:</b> Sensor/actuator cable, unshielded</li> <li>• <b>Application:</b> Uncontaminated zones, Zones with oils and lubricants, Robot, Drag chain operation</li> </ul>	YG2A14-010UB3XLEAX	2145658
	<ul style="list-style-type: none"> <li>• <b>Connection type head A:</b> Female connector, M12, 4-pin, angled, A-coded</li> <li>• <b>Connection type head B:</b> Flying leads</li> <li>• <b>Signal type:</b> Sensor/actuator cable</li> <li>• <b>Cable:</b> 0.6 m, 4-wire, PVC</li> <li>• <b>Description:</b> Sensor/actuator cable, unshielded</li> <li>• <b>Application:</b> Zones with chemicals, Uncontaminated zones</li> </ul>	YG2A14-C60VB3XLEAX	2145709
	<ul style="list-style-type: none"> <li>• <b>Connection type head A:</b> Female connector, M12, 4-pin, angled, A-coded</li> <li>• <b>Connection type head B:</b> Flying leads</li> <li>• <b>Signal type:</b> Sensor/actuator cable</li> <li>• <b>Cable:</b> 1 m, 4-wire, PVC</li> <li>• <b>Description:</b> Sensor/actuator cable, unshielded</li> <li>• <b>Application:</b> Zones with chemicals, Uncontaminated zones</li> </ul>	YG2A14-010VB3XLEAX	2145710
	<ul style="list-style-type: none"> <li>• <b>Connection type head A:</b> Female connector, M12, 4-pin, straight, A-coded</li> <li>• <b>Connection type head B:</b> Flying leads</li> <li>• <b>Signal type:</b> Sensor/actuator cable</li> <li>• <b>Cable:</b> 0.6 m, 4-wire, PVC</li> <li>• <b>Description:</b> Sensor/actuator cable, unshielded</li> </ul>	YF2A14-C60VB3XLEAX	2145707

	Brief description	Type	part no.
	<ul style="list-style-type: none"><li>• <b>Application:</b> Zones with chemicals, Uncontaminated zones</li><li>• <b>Connection type head A:</b> Female connector, M12, 4-pin, straight, A-coded</li><li>• <b>Connection type head B:</b> Flying leads</li><li>• <b>Signal type:</b> Sensor/actuator cable</li><li>• <b>Cable:</b> 1 m, 4-wire, PVC</li><li>• <b>Description:</b> Sensor/actuator cable, unshielded</li><li>• <b>Application:</b> Zones with chemicals, Uncontaminated zones</li></ul>	YF2A14-010VB3XLEAX	2145708

## SICK AT A GLANCE

SICK is one of the leading manufacturers of intelligent sensors and sensor solutions for industrial applications. A unique range of products and services creates the perfect basis for controlling processes securely and efficiently, protecting individuals from accidents and preventing damage to the environment.

We have extensive experience in a wide range of industries and understand their processes and requirements. With intelligent sensors, we can deliver exactly what our customers need. In application centers in Europe, Asia and North America, system solutions are tested and optimized in accordance with customer specifications. All this makes us a reliable supplier and development partner.

Comprehensive services complete our offering: SICK LifeTime Services provide support throughout the machine life cycle and ensure safety and productivity.

For us, that is “Sensor Intelligence.”

## WORLDWIDE PRESENCE:

Contacts and other locations –[www.sick.com](http://www.sick.com)