

OD5000-C150W40

OD5000

DISPLACEMENT MEASUREMENT SENSORS

SICK
Sensor Intelligence.



Ordering information

Type	part no.
OD5000-C150W40	6063626

Other models and accessories → www.sick.com/OD5000



Detailed technical data

Features

Measuring range	110 mm ... 190 mm
Repeatability	0.2 μm ^{1) 2)}
Linearity	Diffuse $\pm 12 \mu\text{m}$ ¹⁾ Specular not supported
Response time	$\geq 0.0125 \text{ ms}$ ^{3) 4)}
Measuring frequency	$\leq 80 \text{ kHz}$ ⁵⁾
Output time	$\geq 0.0125 \text{ ms}$
Emitted beam	
Light source	Laser, red
Typ. light spot size (distance)	120 μm x 4,000 μm
Key laser figures	
Normative reference	IEC 60825-1:2014, EN 60825-1:2014
Laser class	1 ⁶⁾ 7)
Thickness measurement of transparent material	Not supported
Safety-related parameters	
MTTF _D	61 years
DC _{avg}	0%

¹⁾ Measurement on 60 % remission (ceramic, white).

²⁾ Set average: 65536, median: 31, response time: 50 μs , constant application parameters.

³⁾ At 0.0125 ms, measurement is only possible within a sub-range.

⁴⁾ Dependent on the set average or sensitivity.

⁵⁾ At 80 kHz, measurement is only possible in a sub-area.

⁶⁾ Visible, wavelength: 655 nm, max. power: 0.39 mW.

⁷⁾ Do not intentionally look into the laser beam. Never point the laser beam at people's eyes.

Interfaces

Ethernet	✓, TCP/IP, UDP
Digital input	In ₁ Can be used as laser off, external teach-in, or deactivated
Digital output	
Number	1 ... 3 ¹⁾
Type	PNP/NPN, selectable
Analog output	
Number	1
Type	Current output
Function	Optional over evaluation unit AOD1
Current	4 mA ... 20 mA, ≤ 300 Ω

¹⁾ Optional over evaluation unit AOD1.

Electronics

Supply voltage U_B	DC 12 V ... 24 V, ± 10%, including residual ripple
Power consumption	180 mA, at 24 V
Warm-up time	< 10 min
Display	Status LEDs
Enclosure rating	IP67
Protection class	III (EN 50178)
Connection type	
	Cable with male connector, 50 cm

Mechanics

Dimensions (W x H x D)	25.9 mm x 71.5 mm x 53.2 mm
Housing material	Metal (Aluminum die cast)
Window material	Plastic (PMMA)
Weight	280 g

Ambient data

Ambient temperature, operation	-10 °C ... +50 °C, Operating temperature at V _S = 24 V
Ambient temperature, storage	-20 °C ... +60 °C
Relative air humidity (non-condensing)	35 % ... 85 %
Temperature drift	± 0.01 % FS/K at -10 °C ... +40 °C (FS = Full Scale = sensor measuring range) ± 0.03 % FS/K at +40 °C ... +50 °C (FS = Full Scale = sensor measuring range)
Typ. Ambient light immunity	Artificial light: ≤ 3,000 lx ¹⁾ Sunlight: ≤ 10,000 lx
Vibration resistance	EN 60068-2-6, EN 60068-2-64
Shock resistance	EN 60068-2-27

¹⁾ With constant object movement in the measuring range.

Certificates

EU declaration of conformity	✓
UK declaration of conformity	✓

ACMA declaration of conformity	✓
Moroccan declaration of conformity	✓
China RoHS	✓
Information according to Art. 3 of Data Act (Regulation EU 2023/2854)	✓

Classifications

ECLASS 5.0	27270801
ECLASS 5.1.4	27270801
ECLASS 6.0	27270801
ECLASS 6.2	27270801
ECLASS 7.0	27270801
ECLASS 8.0	27270801
ECLASS 8.1	27270801
ECLASS 9.0	27270801
ECLASS 10.0	27270801
ECLASS 11.0	27270801
ECLASS 12.0	27270916
ETIM 5.0	EC001825
ETIM 6.0	EC001825
ETIM 7.0	EC001825
ETIM 8.0	EC001825
UNSPSC 16.0901	41111613

Dimensional drawing OD5000-C150x40

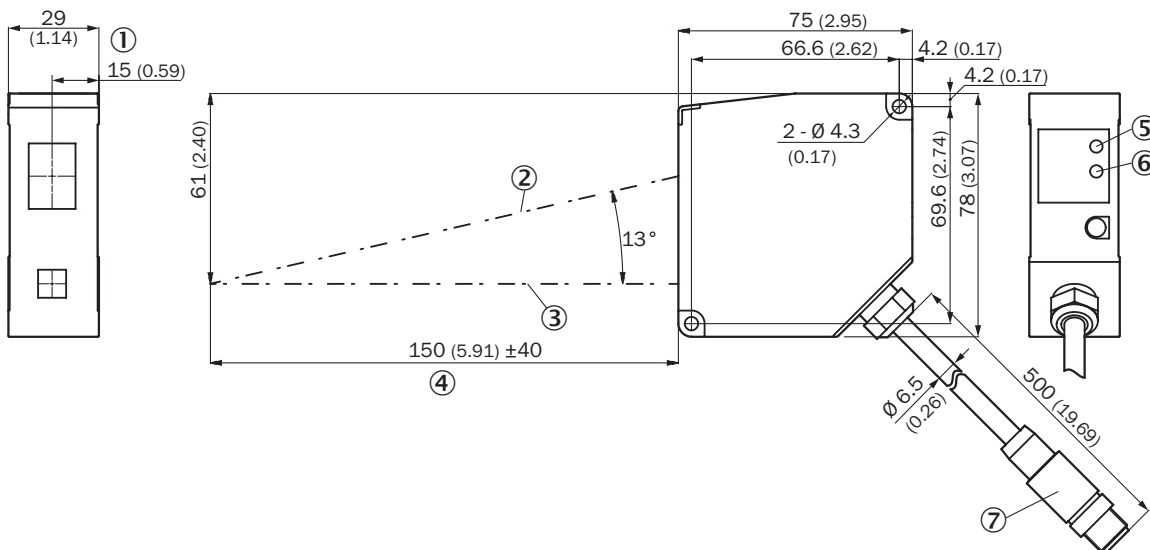

Dimensions in mm (inch)

- ① reference edge
- ② optical axis, receiver
- ③ optical axis, sender

- ④ measuring range
- ⑤ Link LED
- ⑥ status LED
- ⑦ male connector M12, 8-pin

Connection diagram

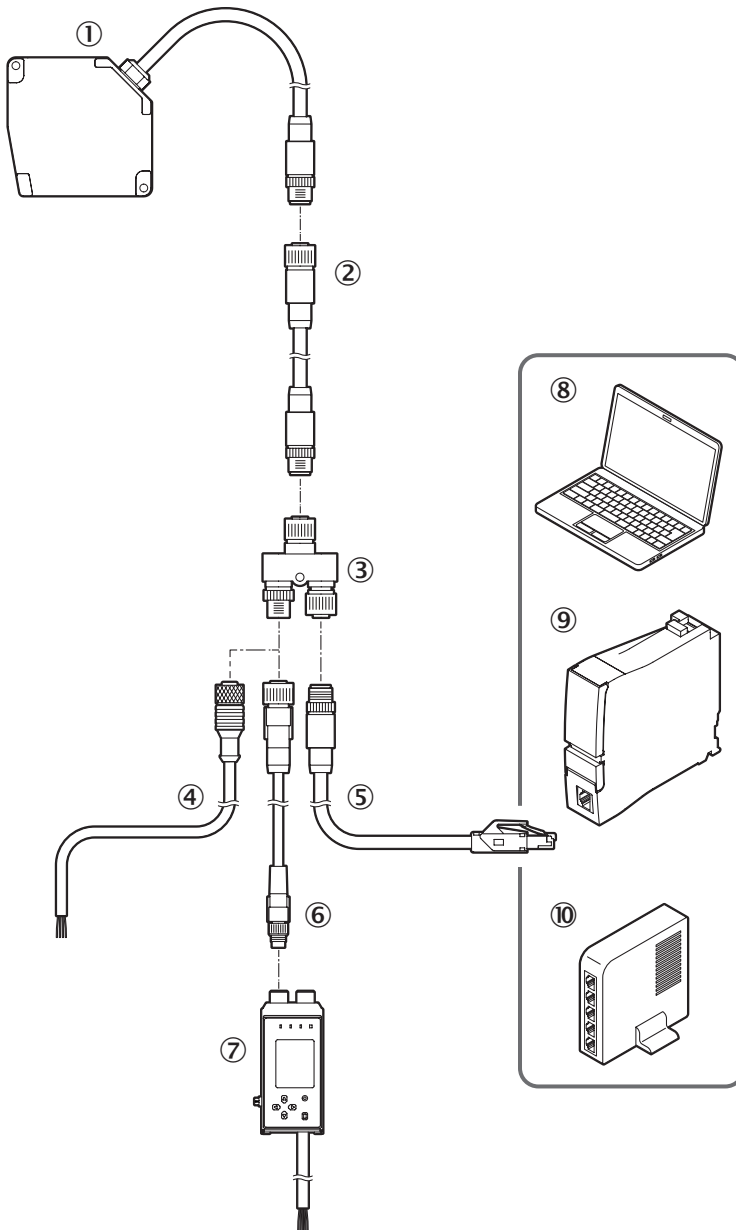

- ① OD5000
- ② Sensor head extension cable
- ③ Y-distribution (included with delivery)
- ④ Cable with open ends
- ⑤ Ethernet Connection cable
- ⑥ AOD1 connection cable, M12, 4-pin to M8, 4-pin
- ⑦ AOD1
- ⑧ PC
- ⑨ PLC

⑩ switch

PIN assignment Y-junctions

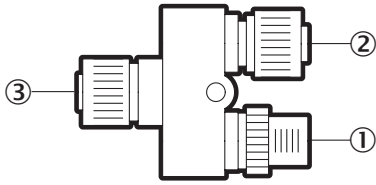

Y-distribution connections

- ① M12, 4-pin, A-coded
- ② M12, 5-pin, D-coded
- ③ M12, 8-pin, A-coded

PIN assignment

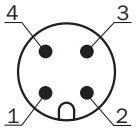

Connector M12, 4-pin, A-coded

- ① 24 V
- ② Input (MF) / RS485+
- ③ 0 V
- ④ Input (MF) / RS485-

PIN assignment

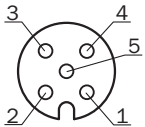

female connector M12, 5-pin, D-coded

- ① TxD+
- ② RxD+
- ③ TxD-
- ④ RxD-
- ⑤ nc

PIN assignment

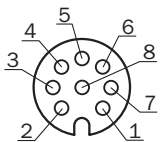

female connector M12, 8-pin, A-coded

- ① Input (MF) / RS485+

- ② 0 V
- ③ 24 V
- ④ TxD-
- ⑤ RxD+
- ⑥ TxD+
- ⑦ Input (MF) / RS485-
- ⑧ RxD-

Light spot size

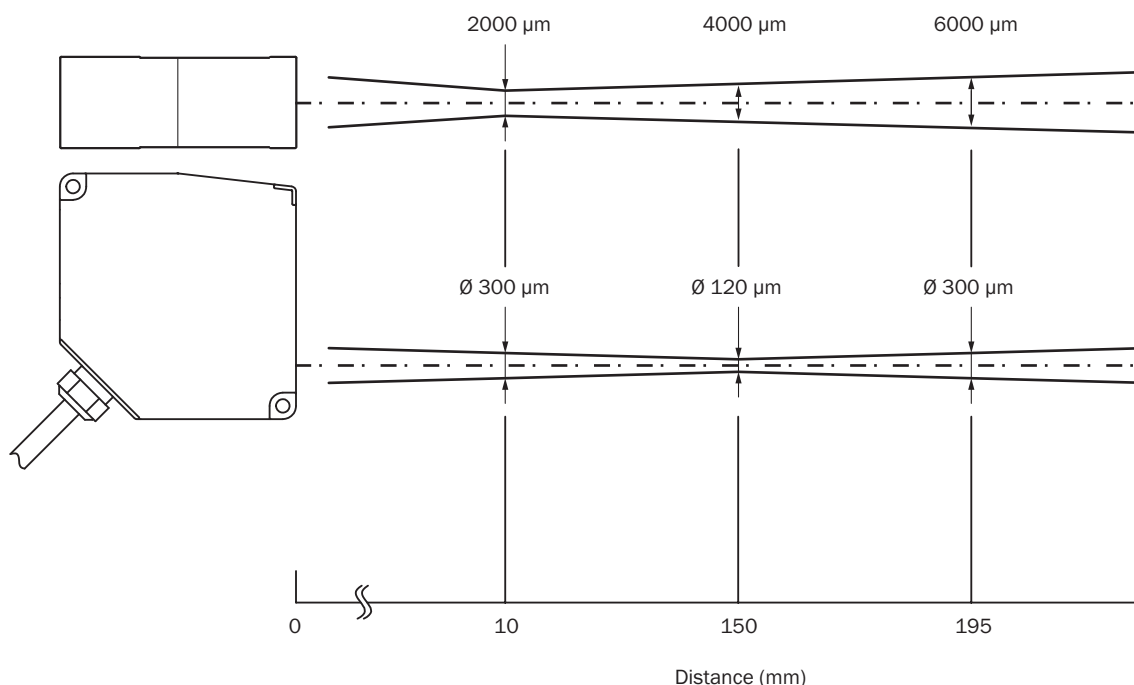

Linearity OD5000-C150W40 (diffuse)

Linearity µm (µin)

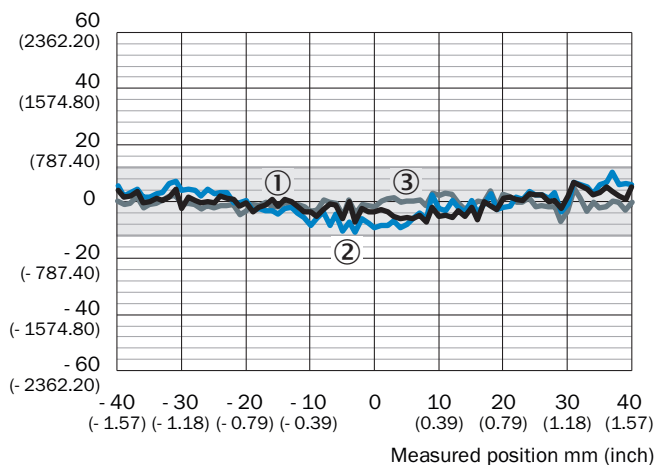













- ① white 60% remission factor
- ② black 9.5% remission factor

③ stainless steel

Recommended accessories

Other models and accessories → www.sick.com/OD5000

	Brief description	Type	part no.
connectors and cables			
	<ul style="list-style-type: none"> • Connection type head A: Female connector, M12, 8-pin, straight • Connection type head B: Male connector, M12, 8-pin, straight • Cable: 2 m, PUR 	DSC-1208-G02MA	6064004
	<ul style="list-style-type: none"> • Description: Sensor/actuator cable, unshielded • Connection type head A: Female connector, M12, 4-pin, straight, A-coded • Connection type head B: Flying leads • Signal type: Sensor/actuator cable • Cable: 2 m, 4-wire, PUR, halogen-free • Application: Drag chain operation, Zones with oils and lubricants, Robot, Drag chain operation 	YF2A14-020UB3XLEAX	2095607
	<ul style="list-style-type: none"> • Connection type head A: Male connector, M12, 4-pin, straight, D-coded • Connection type head B: Male connector, RJ45, 4-pin, straight • Signal type: Ethernet, PROFINET • Cable: 2 m, 4-wire, PUR, halogen-free • Description: Ethernet, shielded, PROFINET • Application: Drag chain operation, Zones with oils and lubricants 	YM2D24-020P-N1MRJA4	2106182
	<ul style="list-style-type: none"> • Description: Sensor/actuator cable, unshielded • Connection type head A: Female connector, M12, 4-pin, straight, A-coded • Connection type head B: Flying leads • Signal type: Sensor/actuator cable • Cable: 0.6 m, 4-wire, PUR, halogen-free • Application: Drag chain operation, Zones with oils and lubricants, Robot, Drag chain operation 	YF2A14-C60UB3XLEAX	2145654
	<ul style="list-style-type: none"> • Description: Sensor/actuator cable, unshielded • Connection type head A: Female connector, M12, 4-pin, straight, A-coded • Connection type head B: Flying leads • Signal type: Sensor/actuator cable • Cable: 1 m, 4-wire, PUR, halogen-free • Application: Drag chain operation, Zones with oils and lubricants, Robot, Drag chain operation 	YF2A14-010UB3XLEAX	2145655
	<ul style="list-style-type: none"> • Description: Sensor/actuator cable, unshielded • Connection type head A: Female connector, M12, 4-pin, straight, A-coded • Connection type head B: Flying leads • Signal type: Sensor/actuator cable • Cable: 3 m, 4-wire, PUR, halogen-free • Application: Drag chain operation, Zones with oils and lubricants, Robot, Drag chain operation 	YF2A14-030UB3XLEAX	2145656
integration modules and adapters			
	<ul style="list-style-type: none"> • Description: OD Mini evaluation unit, master, 1 x Q, M8 male connector, 4-pin 	AOD1-MR24Q1	6054270
	<ul style="list-style-type: none"> • Description: OD Mini evaluation unit, slave, 1 x Q, M8 male connector, 4-pin 	AOD1-SR24Q1	6054271
	<ul style="list-style-type: none"> • Description: OD Mini evaluation unit, master, 2 x Q, M12 male connector, 5-pin 	AOD1-MR25Q2	6054272
	<ul style="list-style-type: none"> • Description: OD Mini evaluation unit, slave, 2 x Q, M12 male connector, 5-pin 	AOD1-SR25Q2	6054273
	<ul style="list-style-type: none"> • Description: OD Mini evaluation unit, OD5000 and OL1, master, 3 x Q, 1 x analog, open end cable, 2 m 	AOD1-MR27C4	6058195
	<ul style="list-style-type: none"> • Description: OD Mini evaluation unit, OD5000 and OL1, slave, 3 x Q, 1 x analog, open end cable, 2 m 	AOD1-SR27C4	6058196

SICK AT A GLANCE

SICK is one of the leading manufacturers of intelligent sensors and sensor solutions for industrial applications. A unique range of products and services creates the perfect basis for controlling processes securely and efficiently, protecting individuals from accidents and preventing damage to the environment.

We have extensive experience in a wide range of industries and understand their processes and requirements. With intelligent sensors, we can deliver exactly what our customers need. In application centers in Europe, Asia and North America, system solutions are tested and optimized in accordance with customer specifications. All this makes us a reliable supplier and development partner.

Comprehensive services complete our offering: SICK LifeTime Services provide support throughout the machine life cycle and ensure safety and productivity.

For us, that is “Sensor Intelligence.”

WORLDWIDE PRESENCE:

Contacts and other locations –www.sick.com