



# UM30-213111S12

UM30

ULTRASONIC DISTANCE SENSORS

**SICK**  
Sensor Intelligence.



### Ordering information

Type	part no.
UM30-213111S12	6057291

Other models and accessories → [www.sick.com/UM30](http://www.sick.com/UM30)



### Detailed technical data

#### Features

<b>Operating range, limiting range</b>	200 mm ... 1,300 mm, 2,000 mm
<b>Target</b>	Natural objects
<b>Resolution</b>	≥ 0.18 mm
<b>Repeatability</b>	± 0.15 % <sup>1)</sup>
<b>Measurement accuracy</b>	± 1 % <sup>2) 3)</sup>
<b>Temperature compensation</b>	✓
<b>Response time</b>	92 ms
<b>Switching frequency</b>	8 Hz
<b>Output time</b>	23 ms
<b>Ultrasonic frequency (typical)</b>	200 kHz
<b>Detection area (typical)</b>	See diagrams
<b>Additional function</b>	Adjustable operating modes: Switching point (DtO) / Switching window/Background (ObSB), teach-in of digital output, set levels of digital outputs, invertable digital output, set on delay digital output, synchronization of up to 50 sensors, multiplexing: no cross talk of up to 50 sensors, adjustable measurement filters: Measured value filters/Filter strength/Foreground suppression/Detection area/Sensitivity and sound beam, Display (can be deactivated), reset to factory default
<b>Special characteristic</b>	Platform detection

<sup>1)</sup> In relation to the current measured value, minimum value ≥ resolution.

<sup>2)</sup> Referring to current measurement value.

<sup>3)</sup> Temperature compensation can be switched off, without temperature compensation: 0.17 % / K.

#### Interfaces

<b>Digital output</b>	Number	1 <sup>1)</sup>
-----------------------	--------	-----------------

<sup>1)</sup> PNP: HIGH = V<sub>S</sub> - (< 2 V) / LOW = 0 V.

Type	PNP
Maximum output current $I_A$	$\leq 200$ mA
<b>Multifunctional input (MF)</b>	1 x MF
<b>Hysteresis</b>	20 mm

<sup>1)</sup> PNP: HIGH =  $V_S - (< 2$  V) / LOW = 0 V.

## Electronics

<b>Supply voltage <math>U_B</math></b>	DC 9 V ... 30 V <sup>1)</sup>
<b>Power consumption</b>	$\leq 2.4$ W <sup>2)</sup>
<b>Initialization time</b>	< 300 ms
<b>Indication</b>	LED display, 2 x LED
<b>Enclosure rating</b>	IP65 / IP67
<b>Protection class</b>	III

<sup>1)</sup> Limit values, reverse-polarity protected Operation in short-circuit protected network: max. 8 A, class 2.

<sup>2)</sup> Without load.

## Mechanics

<b>Dimensions (W x H x D)</b>	30 mm x 30 mm x 84 mm
<b>Design</b>	Cylindrical
<b>Sending axis</b>	Straight
<b>Housing material</b>	Metal (nickel-plated brass, PBT, ultrasonic transducer: polyurethane foam, glass epoxy resin)
<b>Weight</b>	150 g
<b>Thread size</b>	M30 x 1.5
<b>Connection type</b>	Male connector, M12, 5-pin

## Ambient data

<b>Ambient temperature, operation</b>	-25 °C ... +70 °C
<b>Ambient temperature, storage</b>	-40 °C ... +85 °C

## Certificates

<b>EU declaration of conformity</b>	✓
<b>UK declaration of conformity</b>	✓
<b>ACMA declaration of conformity</b>	✓
<b>cULus certificate</b>	✓

## Classifications

<b>ECLASS 5.0</b>	27270804
<b>ECLASS 5.1.4</b>	27270804
<b>ECLASS 6.0</b>	27270804
<b>ECLASS 6.2</b>	27270804
<b>ECLASS 7.0</b>	27270804
<b>ECLASS 8.0</b>	27270804
<b>ECLASS 8.1</b>	27270804
<b>ECLASS 9.0</b>	27270804

<b>ECLASS 10.0</b>	27270804
<b>ECLASS 11.0</b>	27270804
<b>ECLASS 12.0</b>	27272806
<b>ETIM 5.0</b>	EC001846
<b>ETIM 6.0</b>	EC001846
<b>ETIM 7.0</b>	EC001846
<b>ETIM 8.0</b>	EC001846
<b>UNSPSC 16.0901</b>	41111960

Dimensional drawing UM30-211, UM30-212, UM30-213

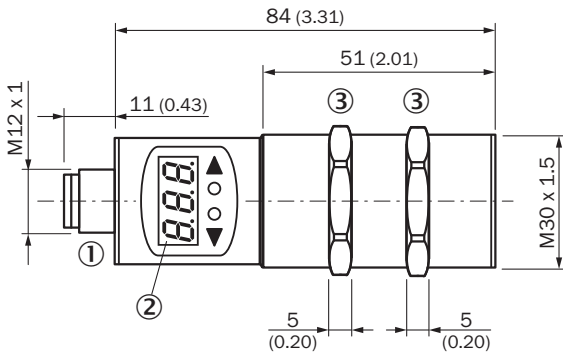

Dimensions in mm (inch)

- ① Connection
- ② Display
- ③ Mounting nuts, SW 36 mm

Connection type

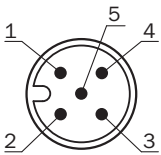

Connection diagram UM30-21x111 UM30-21x114 Connector M12, 5-pin

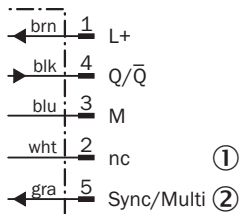

- ① Not assigned
- ② Synchronization and multiplex mode, Connect+ communication

### Adjustment possible

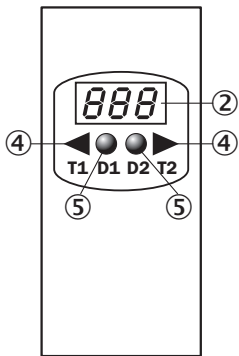

- ② Display
- ④ Control elements
- ⑤ Status indicators

### Detection area



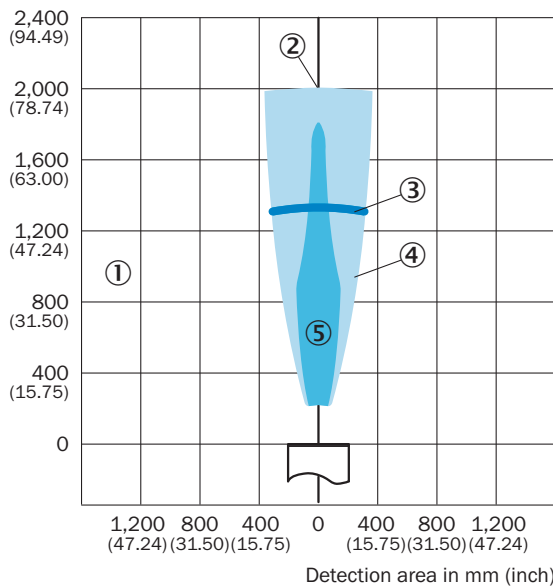

Detection area in mm (inch)



- ① Detection range dependent on reflection properties, size, and alignment of the object
- ② Limiting range
- ③ operating range
- ④ example object: aligned plate 500 mm x 500 mm
- ⑤ example object: pipe with 27 mm diameter

Recommended accessories

Other models and accessories → [www.sick.com/UM30](http://www.sick.com/UM30)

	Brief description	Type	part no.
Mounting systems			
	<ul style="list-style-type: none"> <li><b>Description:</b> Mounting bracket for M30 sensors</li> <li><b>Material:</b> Steel</li> <li><b>Details:</b> Steel, zinc coated</li> <li><b>Items supplied:</b> Without mounting hardware</li> </ul>	BEF-WN-M30	5308445
connectors and cables			
	<ul style="list-style-type: none"> <li><b>Description:</b> Sensor/actuator cable, unshielded</li> <li><b>Connection type head A:</b> Female connector, M12, 5-pin, straight, A-coded</li> <li><b>Connection type head B:</b> Flying leads</li> <li><b>Signal type:</b> Sensor/actuator cable</li> <li><b>Cable:</b> 2 m, 5-wire, PVC</li> <li><b>Application:</b> Untaminated zones, Zones with chemicals</li> </ul>	YF2A15-020VB5XLEAX	2096239
	<ul style="list-style-type: none"> <li><b>Description:</b> Sensor/actuator cable, unshielded</li> <li><b>Connection type head A:</b> Female connector, M12, 5-pin, straight, A-coded</li> <li><b>Connection type head B:</b> Flying leads</li> <li><b>Signal type:</b> Sensor/actuator cable</li> <li><b>Cable:</b> 0.6 m, 5-wire, PVC</li> <li><b>Application:</b> Untaminated zones, Zones with chemicals</li> </ul>	YF2A15-C60VB5XLEAX	2145570
	<ul style="list-style-type: none"> <li><b>Description:</b> Sensor/actuator cable, unshielded</li> <li><b>Connection type head A:</b> Female connector, M12, 5-pin, straight, A-coded</li> <li><b>Connection type head B:</b> Flying leads</li> <li><b>Signal type:</b> Sensor/actuator cable</li> <li><b>Cable:</b> 3 m, 5-wire, PVC</li> <li><b>Application:</b> Untaminated zones, Zones with chemicals</li> </ul>	YF2A15-030VB5XLEAX	2145572

## SICK AT A GLANCE

SICK is one of the leading manufacturers of intelligent sensors and sensor solutions for industrial applications. A unique range of products and services creates the perfect basis for controlling processes securely and efficiently, protecting individuals from accidents and preventing damage to the environment.

We have extensive experience in a wide range of industries and understand their processes and requirements. With intelligent sensors, we can deliver exactly what our customers need. In application centers in Europe, Asia and North America, system solutions are tested and optimized in accordance with customer specifications. All this makes us a reliable supplier and development partner.

Comprehensive services complete our offering: SICK LifeTime Services provide support throughout the machine life cycle and ensure safety and productivity.

For us, that is “Sensor Intelligence.”

## WORLDWIDE PRESENCE:

Contacts and other locations –[www.sick.com](http://www.sick.com)