



# TR10-SRM03P

TR10 Lock

SAFETY LOCKING DEVICES

**SICK**  
Sensor Intelligence.



### Ordering information

Type	part no.
TR10-SRM03P	6054756

Other models and accessories → [www.sick.com/TR10\\_Lock](http://www.sick.com/TR10_Lock)



### Detailed technical data

#### Features

<b>Sensor principle</b>	RFID
<b>Locking principle</b>	Power to release
<b>Number of safe outputs</b>	2
<b>Coding</b>	Universally coded
<b>Locking force <math>F_{max}</math></b>	1,690 N (EN ISO 14119)
<b>Locking force <math>F_{Zh}</math></b>	1,300 N (EN ISO 14119)
<b>Retaining force</b>	0 N
<b>Actuation directions</b>	4
<b>Approach speed</b>	≥ 2 mm/s

#### Safety-related parameters

<b>Safety integrity level</b>	SIL 3 (IEC 61508)
<b>Category</b>	Category 4 (EN ISO 13849)
<b>Performance level</b>	PL e (EN ISO 13849)
<b>PFH<sub>D</sub> (mean probability of a dangerous failure per hour)</b>	$9.1 \times 10^{-10}$
<b>T<sub>M</sub> (mission time)</b>	20 years (EN ISO 13849)
<b>Type</b>	Type 4 (EN ISO 14119)
<b>Actuator coding level</b>	Low coding level (EN ISO 14119)
<b>Safe state in the event of a fault</b>	At least one safety-related semiconductor output (OSSD) is in the OFF state.

#### Functions

<b>Switching behavior of the OSSDs</b>	Locking monitoring
<b>Safe series connection</b>	In control cabinet (with diagnostics)

## Interfaces

<b>Connection type</b>	Cable
Length of cable	3 m
Long connecting cable	≤ 200 m
Cable diameter	6.5 mm
Conductor cross section	0.25 mm <sup>2</sup>
Bend radius (with fixed installation)	> 7 x cable diameter
Bend radius (with moving cable)	> 14 x cable diameter
Cable material	PVC
Conductor material	Copper
Coupling nut material	Stainless steel
<b>Display elements</b>	LEDs
Diagnostics indicator	✓
Status display	✓

## Electronics

<b>Protection class</b>	II (IEC 61140)
<b>Contamination rating</b>	3
<b>Classification according to cULus</b>	Class 2
<b>Usage category</b>	DC-13 (IEC 60947-5-1)
<b>Rated operating current (voltage)</b>	200 mA (24 V DC)
<b>Rated insulation voltage U<sub>i</sub></b>	75 V
<b>Rated impulse withstand voltage U<sub>imp</sub></b>	1,000 V
<b>Supply voltage V<sub>s</sub></b>	24 V DC (20.4 V DC ... 26.4 V DC)
<b>Type of output</b>	Self-monitoring semiconductor outputs (OSSDs)
<b>Output current</b>	≤ 200 mA
<b>Peak current</b>	400 mA, 100 ms <sup>1)</sup>
<b>Power consumption</b>	2.5 W
<b>Response time</b>	100 ms for the first switch, 50 ms for each subsequent switch <sup>2)</sup>
<b>Release time</b>	600 ms
<b>Risk time</b>	100 ms
<b>Switch-on time</b>	7 s
<b>Locking principle</b>	Power to release

<sup>1)</sup> During switching on, locking, or unlocking.

<sup>2)</sup> Time until the outputs are switched off.

## Mechanics

<b>Weight</b>	0.4 kg
<b>Housing material</b>	ABS
<b>Locking bolt material</b>	Stainless steel 304
<b>Mechanical life</b>	5 x 10 <sup>5</sup> switching cycles

## Ambient data

<b>Enclosure rating</b>	IP66, IP67, IP69K (IEC 60529, IEC 60529, IEC 60529)
-------------------------	---

<b>Ambient operating temperature</b>	0 °C ... +55 °C
<b>Storage temperature</b>	-25 °C ... +75 °C
<b>Vibration resistance</b>	10 Hz ... 55 Hz (IEC 60068-2-6)
<b>Shock resistance</b>	30 g, 11 ms (EN 60068-2-27)
<b>EMC</b>	IEC 60947-5-3

### Certificates

<b>EU declaration of conformity</b>	✓
<b>UK declaration of conformity</b>	✓
<b>ACMA declaration of conformity</b>	✓
<b>China RoHS</b>	✓
<b>cULus certificate</b>	✓
<b>Third party certificate</b>	✓

### Classifications

<b>ECLASS 5.0</b>	27272603
<b>ECLASS 5.1.4</b>	27272603
<b>ECLASS 6.0</b>	27272603
<b>ECLASS 6.2</b>	27272603
<b>ECLASS 7.0</b>	27272603
<b>ECLASS 8.0</b>	27272603
<b>ECLASS 8.1</b>	27272603
<b>ECLASS 9.0</b>	27272603
<b>ECLASS 10.0</b>	27272603
<b>ECLASS 11.0</b>	27272603
<b>ECLASS 12.0</b>	27272603
<b>ETIM 5.0</b>	EC002593
<b>ETIM 6.0</b>	EC002593
<b>ETIM 7.0</b>	EC002593
<b>ETIM 8.0</b>	EC002593
<b>UNSPSC 16.0901</b>	39122205

Dimensional drawing Sensor with cable

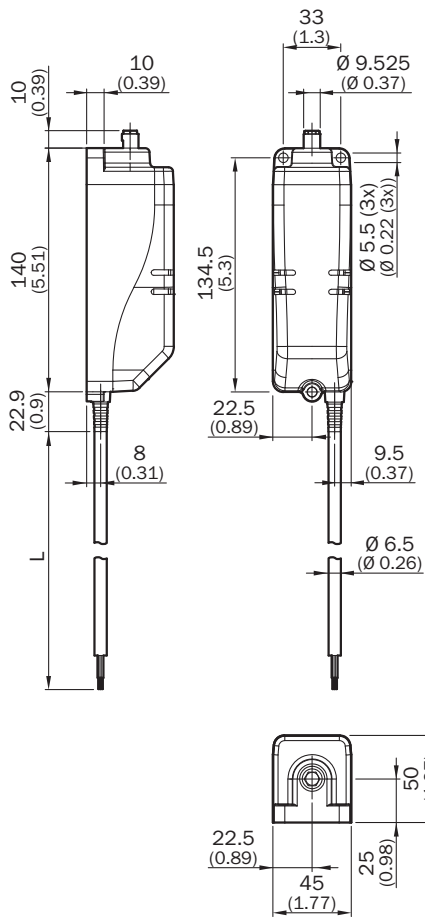

Dimensions in mm (inch)

Dimensional drawing Actuator and mounting bracket

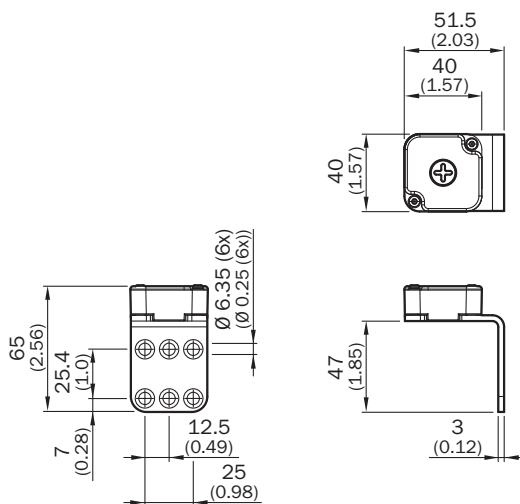

Dimensions in mm (inch)

### Pinouts

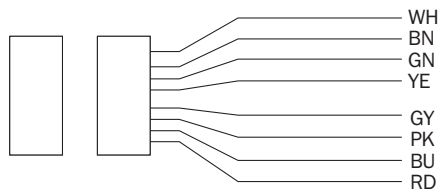

White	Aux output (not safe)
Brown	Voltage supply 24 V DC
Green	Lock control
Yellow	OSSD 2 input
Gray	OSSD 1 output
Pink	OSSD 2 output
Blue	Voltage supply 0 V DC
Red	OSSD 1 input

### Series connection with T-piece (without diagnostics)

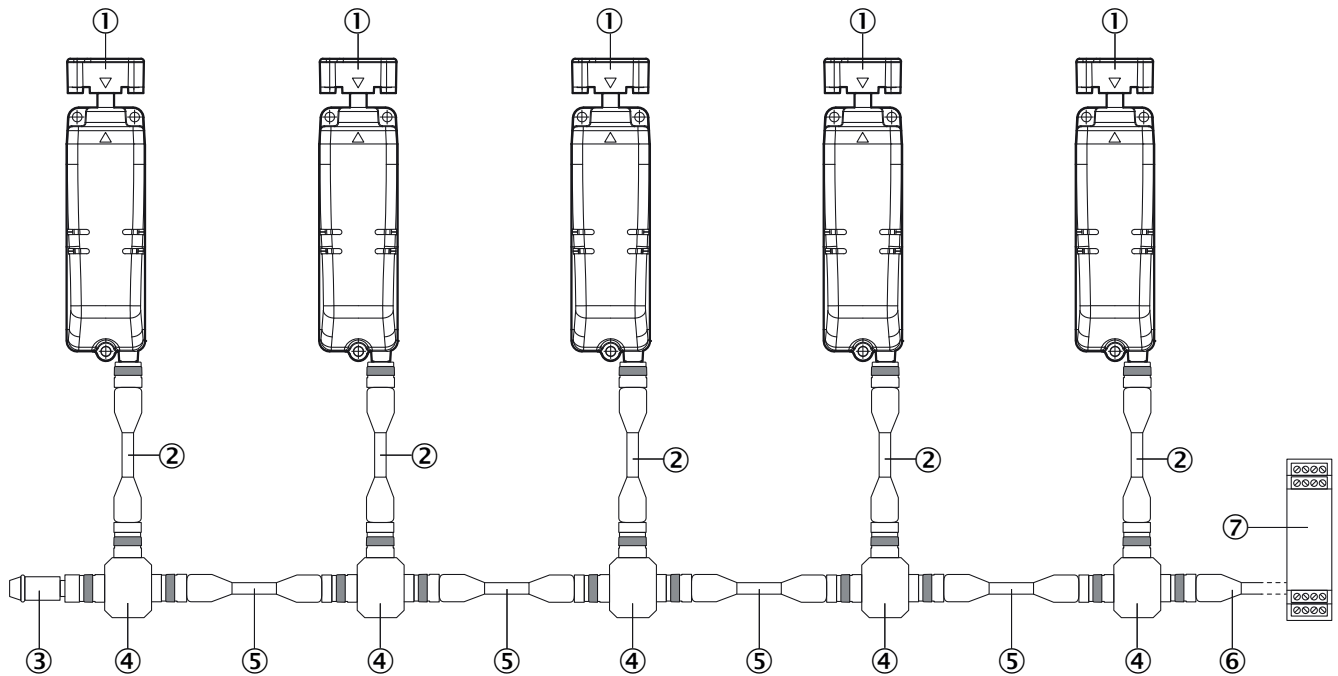

- ① TR10 Lock safety locking device
- ② Connection cable with 8-pin, M12 male connector and 8-pin, M12 female connector (e.g., DSL-1208-xxxx)
- ③ MLP1-XXT end connector
- ④ STR1-XXA T-connector
- ⑤ Connection cable with 5-pin, M12 male connector and 5-pin, M12 female connector (e.g., DSL-1205-xxxx)
- ⑥ connecting cable with M12 female connector, 5-pin and flying leads (e.g., DOL-1205-xxxx)
- ⑦ Safe evaluation unit

Connection diagram Series connection of three TR10 Lock safety locking devices to a Flexi Classic safety controller

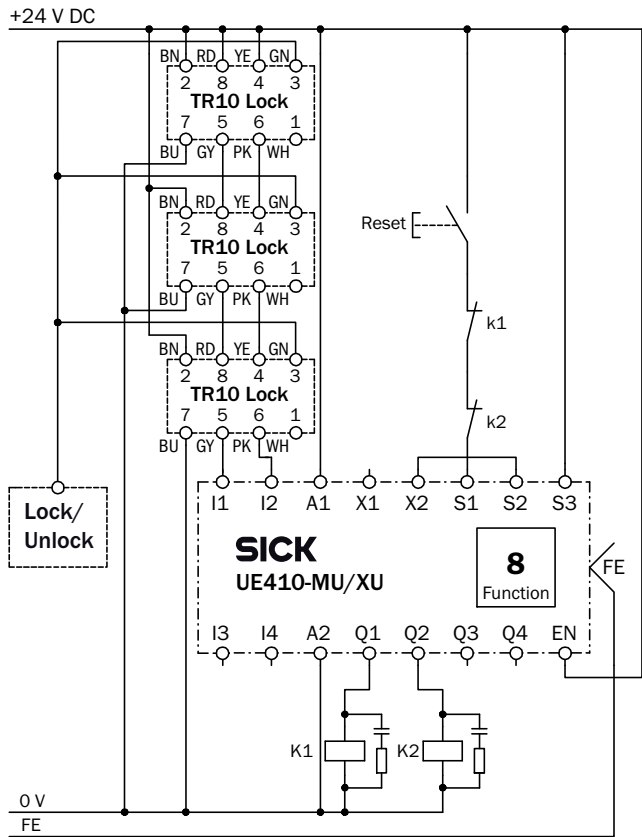

E156014/00/2016-06-09

Recommended accessories

Other models and accessories → [www.sick.com/TR10\\_Lock](http://www.sick.com/TR10_Lock)

	Brief description	Type	part no.
Mounting systems			
	<ul style="list-style-type: none"> <li><b>Description:</b> Safety screws for mounting bracket of actuator</li> <li><b>Packing unit:</b> 10 pieces</li> </ul>	Safety screws M5 x 10	5334497

## SICK AT A GLANCE

SICK is one of the leading manufacturers of intelligent sensors and sensor solutions for industrial applications. A unique range of products and services creates the perfect basis for controlling processes securely and efficiently, protecting individuals from accidents and preventing damage to the environment.

We have extensive experience in a wide range of industries and understand their processes and requirements. With intelligent sensors, we can deliver exactly what our customers need. In application centers in Europe, Asia and North America, system solutions are tested and optimized in accordance with customer specifications. All this makes us a reliable supplier and development partner.

Comprehensive services complete our offering: SICK LifeTime Services provide support throughout the machine life cycle and ensure safety and productivity.

For us, that is “Sensor Intelligence.”

## WORLDWIDE PRESENCE:

Contacts and other locations –[www.sick.com](http://www.sick.com)